

S-series PTZ camera with AI Engine

5MP 10x Outdoor PTZ Network Camera

S-series models come standard with AI automatic tracking. It can automatically detect, zoom, and track intruders in a wide area, thereby supporting surveillance operators in many scenes. It also achieves the industry's highest level of drive durability to withstand high-speed and high-frequency camera movement by the automatic monitoring function.

AI monitoring camera, standard with AI Auto-tracking

- AI analysis functionality is standard on the camera side to promote automated surveillance. Accurately detects people and vehicles and automatically zooms in on intruders. Support surveillance operators to ensure that no tracked object is missed.
- Additional applications can be installed (up to two applications) to expand analysis functions such as AI privacy guard, person/vehicle attribute detection, etc.

Highly durable pan-tilt drive unit Reduced maintenance costs

- High durability gear drive achieves PAN and TILT drive durability (3.7 million movements). Low failure rate even with high frequency drive and reduced maintenance cost by minimizing the maintenance cycle.

Easy installation

- S-series compact PTZ cameras can be installed discreetly and easily on low ceilings.
- Easy kitting packaging allows the camera to be set up without removing it from the box during kitting prior to installation.
- The 10x models of the S-Series outdoor DOME are shipped with a waterproof LAN extension cable installed. The DOME can be installed without opening the DOME at sites where conventional pigtailed are used.
- The addition of a diverse lineup of mounting brackets and optional PoE injectors enables flexible installation regardless of the location of new or existing installations.

High security standard

- Highest level of security. In addition to digital certificates issued by a third-party organization (GlobalSign®), FIPS 140-2 Level 3 certified EdgeLock® SE050F secure element (NXP® Semiconductors) is embedded.

Key i-PRO Spec.

- 5MP
- 10x optical zoom
- Intelligent Auto (with AI Engine)
- Super Dynamic 132dB
- Color night vision (0.007 to 0.11 lx) (G: 0.020 to 0.32 lx)
- Durable Pan/Tilt gear mechanism
- IP66, IK10 certified
- ONVIF® Profile G / M / S / T *ONVIF is a trademark of ONVIF, Inc.
- FIPS 140-2 level 3 certified
*Built-in EdgeLock® SE050F (NXP® Semiconductors)
- NDAA Compliant



WV-S65501-Z1



WV-S65501-Z1G (Smoke Dome)

Specifications

| | | |
|-----------------------------|--|---|
| Camera | Image Sensor | Approx. 1/2.8 type CMOS image sensor |
| | Minimum Illumination | Color : 0.11 lx (G: 0.32 lx) (50IRE, F1.6, 1/30s) Color : 0.007 lx (G: 0.020 lx) (50IRE, F1.6, 16/30s) ^{*1} BW : 0.06 lx (G: 0.18 lx) (50IRE, F1.6, 1/30s) BW : 0.004 lx (G: 0.011 lx) (50IRE, F1.6, 16/30s) |
| | White Balance | ATW1 / ATW2 / AWC |
| | Shutter Speed | [30 fps/15 fps mode] 1/30 Fix to 1/10000 Fix [25 fps/12.5 fps mode] 1/25 Fix to 1/10000 Fix |
| | Intelligent Auto | On / Off |
| | Super Dynamic | On / Off, The level can be set in the range of 0 to 31. |
| | Dynamic Range | Max.132 dB (Super Dynamic : On, Level 31) ^{*2} When the level is set more than 30, frame rate is limited to 15fps |
| | Adaptive Black Stretch | The level can be set in the range of 0 to 255. |
| | Back light compensation / High light compensation | BLC (Back light compensation) / HLC (High light compensation) / Off |
| | Fog compensation | On / Off, The level can be set in the range of 0 to 8 (only when Intelligent auto / auto contrast adjust : Off) |
| | Maximum gain (AGC) | The level can be set in the range of 0 to 11. |
| | Color/BW (ICR) | Off / On / Auto1 / Auto2 / Auto3 (SCC) |
| | Digital Noise Reduction | The level can be set in the range of 0 to 255. |
| | Video Motion Detection (VMD) | On / Off, 4 areas available |
| | Scene Change Detection (SCD) | On / Off, 1 areas available |
| | Audio Detection | On / Off |
| | AI Sound Classification | Gunshot, Yell, Vehicle horn, Glass break |
| | AI Analytics | Yes |
| | Privacy Zone | On / Off, Up to 32 zones available |
| | VIQS | On / Off, Up to 8 zones available |
| Image Stabilizer | On / Off | |
| Camera Title (OSD) | On / Off, Up to 40 characters (alphanumeric characters, marks) | |
| Focus Adjustment | Auto focus | |
| Lens | Optical zoom | 10x (Motorized zoom / Motorized Focus) |
| | Extra zoom | Max. 15x (10 to 15x : When resolution is 1280 x 720) |
| | Focal length | 4.7 - 47 mm (3/16 inches - 1-27/32 inches) |
| | Angular Field of View | [16 : 9 mode] Horizontal : 6.2° (TELE) - 58° (WIDE), Vertical : 3.5° (TELE) - 34° (WIDE) [4 : 3 mode] Horizontal : 6.2° (TELE) - 58° (WIDE), Vertical : 4.6° (TELE) - 44° (WIDE) |
| Maximum Aperture Ratio | 1 : 1.6 (WIDE) - 1 : 3.0 (TELE) | |
| Focus range | 1.5 m (59-1/16 inches) - ∞ | |
| DORI | Detect (25ppm / 8ppf) | Wide: 92.4 m / 110.8 m (303 ft / 363.7 ft), Tele: 945.4 m / 1134.5 m (3101.6 ft / 3722 ft) |
| | Observe (62.5ppm / 19ppf) | Wide: 36.9 m / 44.3 m (121.2 ft / 145.5 ft), Tele: 378.2 m / 453.8 m (1240.7 ft / 1488.8 ft) |
| | Recognize (125ppm / 38ppf) | Wide: 18.5 m / 22.2 m (60.6 ft / 72.7 ft), Tele: 189.1 m / 226.9 m (620.3 ft / 744.4 ft) |
| | Identify (250ppm / 76ppf) | Wide: 9.2 m / 11.1m (30.3 ft / 36.4 ft), Tele: 94.5 m / 113.4 m (310.2 ft / 372.2 ft) |
| System on Chip (SoC) | | Ambarella CV22 |
| Adjusting Angle | | Horizontal : 360° Endless Panning, Vertical : -15° to +195°, Yaw : 0° |
| Pan/tilt | Panning Range | 360° Endless Panning |
| | Panning Speed | Manual: Approx. 0.065°/s - 150°/s Preset: Up to approx. 500°/s (PoE+) Preset: Up to approx. 350°/s (DC12V, PoE) |
| | Tilting Range | Operational -15 - +195° |
| | Tilting Speed | Manual: Approx. 0.065°/s - 150°/s Preset: Up to approx. 500°/s (PoE+) Preset: Up to approx. 300°/s (DC12V, PoE) |
| | Preset Positions | 256 positions |
| | Auto Mode | Auto Track / Auto pan / Preset sequence / Patrol |
| Self Return | 10 s / 20 s / 30 s / 1 min / 2 min / 3 min / 5 min / 10 min / 20 min / 30 min / 60 min | |
| Browser GUI | Camera Control | Brightness, AUX On / Off |
| | Audio | Mic (Line) Input : On / Off Volume adjustment : Low / Middle / High Audio Output : On / Off Volume adjustment : Low / Middle / High |
| | GUI / Setup Menu Language | English, Italian, French, German, Spanish, Portuguese, Russian, Chinese, Japanese |
| Browser ² | | Microsoft Edge, Firefox, Google Chrome |
| Network | Network IF | 10Base-T / 100Base-TX, RJ45 connector |
| | Resolution | [16 : 9 mode (30 fps mode)], [16 : 9 mode (25 fps mode)] 3072x1728 ^{*3} , 2560x1440, 1920x1080, 1280x720, 640x360, 320x180 [4 : 3 mode (30 fps mode)], [4 : 3 mode (25 fps mode)] 3072x2304 ^{*3} , 2560x1920, 1280x960, 800x600, VGA, 400x300, 320x240 |
| | H.265 / H.264 ⁴ | Transmission Mode Constant bit rate / VBR / Frame rate / Best effort |
| | JPEG | Transmission Type Unicast port (AUTO) / Unicast port (MANUAL) / Multicast Image Quality 10 steps |

| | | |
|------------------------|--|---|
| Network | Smart Coding | GOP (Group of pictures) control: Off / Low (Variable GOP 1s-8s) / Mid (Variable GOP 4s-16s) / Advanced(Fixed GOP 60s w/1s key-frame) / Frame rate control (Variable GOP 4s-16s with frame rate control) ^{*4} Advanced and Frame rate control are only available with H.265. Smart Coding: Auto VIQS: On/Off |
| | Audio Compression | G.726 (ADPCM) : 16 kbps / 32 kbps G.711 : 64 kbps AAC-LC ⁵ : 64 kbps / 96 kbps / 128 kbps |
| | Audio transmission mode | Off / Mic (Line) input / Audio output / Interactive (Half duplex) / Interactive (Full duplex) |
| | Supported Protocol | IPv6 : TCP/IP, UDP/IP, HTTP, HTTPS, SSL/TLS, SMTP, DNS, NTP, SNMPv1/v2/v3, DHCPv6, RTP, MLD, ICMP, ARP, IEEE 802.1X, DiffServ, SFTP, MQTT, LLDP IPv4 : TCP/IP, UDP/IP, HTTP, HTTPS, SSL/TLS, RTSP, RTP, RTP/RTCP, SMTP, DHCP, DNS, DDNS, NTP, SNMPv1/v2/v3, UPnP, IGMP, ICMP, ARP, IEEE 802.1X, DiffServ, SRTP, SFTP, MQTT, NTCIP |
| | No. of Simultaneous Users | Up to 14 users (Depends on network conditions) |
| | Secure | FIPS 140-2 level 3 (NXP® EdgeLock® SE050F), Device Certificate GlobalSign® pre-installed, User authentication, Host authentication, HTTPS, Data encryption, 802.1X Support |
| | SDXC/SDHC/SD Memory Card | H.265 / H.264 recording : Manual REC / Alarm REC (Pre/Post) / Schedule REC / Backup upon network failure JPEG recording : Manual REC / Alarm REC (Pre/Post) / Backup upon network failure Compatible SDXC/SDHC/SD Memory Card : microSDXC memory card : 64 GB, 128 GB, 256 GB, 512 GB microSDHC memory card : 4 GB, 8 GB, 16 GB, 32 GB microSD memory card : 2 GB |
| | Mobile Terminal Compatibility | iPad, iPhone (iOS 8.0 or later), Android™ terminals |
| | ONVIF® Profile | G / M / S / T |
| | Alarm | Alarm Source |
| Alarm Actions | | SDXC/SDHC/SD memory recording, E-mail notification, HTTP alarm notification Indication on browser, TCP alarm notification output |
| Input/ Output | Audio input | Ø3.5 mm stereo mini jack |
| | For microphone input: | Recommended applicable microphone : Plug-in power type (Sensitivity of microphone : -51 dB to -38 dB (0 dB=1V/Pa, 1 kHz)) Input impedance : Approx. 2 kΩ (unbalanced) Supply voltage : 2.5 V ±0.5 V |
| | For line input: | Input level : Approx. -10 dBV |
| Audio Output | Ø3.5 mm stereo mini jack (monaural output) Output impedance : Approx. 600 Ω (unbalanced) Output level : -20 dBV | |
| External I/O Terminals | ALARM IN 1 (Alarm input 1/ Black & white input/ Auto time adjustment input) (x1) ALARM IN 2 (Alarm input 2/ ALARM OUT) (x1), ALARM IN 3 (Alarm input 3/ AUX OUT) (x1) | |
| General | Safety | UL (UL62368-1), c-UL (CSA C22.2 No.62368-1), CE, IEC62368-1 |
| | EMC | FCC (Part15 ClassA), ICES-003 Issue 7 ClassA, EN55032 ClassA, EN55035 |
| | Power Source and Power Consumption | DC12 V, PoE (IEEE802.3af), PoE+ (IEEE802.3at) When using at TILT rotation speed 300dps DC12 V : 1.3 A / approx. 15.4 W PoE DC 48 V : 270 mA / approx. 12.95 W (Class 0 device) When using at TILT rotation speed 500dps PoE+ DC 54 V : 350 mA / approx. 18.9 W (Class 4 device) |
| | Ambient Operating Temperature | -30 °C to +55 °C (-22 °F to +131 °F) (Power On range : -20 °C to +55 °C (-4 °F to +131 °F)) Maximum temperature according to NEMA TS2(2.2.7) : 74 °C(165 °F) |
| | Ambient Operating Humidity | 10 to 100 % (no condensation) |
| | Anti-Condensation System | Temish element |
| | Water and Dust Resistance | IP66, IEC60529 measuring standard compatible, Type 4X(UL50E), NEMA 4X compliant |
| | Shock Resistance | IK10 (IEC 62262) |
| | Other standard support | NEMA TS2(2.2.7-2.2.9) |
| | Dimensions | Ø165 mm x 139 mm (H) [Ø6-1/2 inches x 5-15/32 inches (H)] |
| Mass (approx.) | Approx. 1.6 kg (3.5 lbs.) | |
| Finish | Main body : Aluminum die cast, Black polycarbonate resin, i-PRO white Outer fixing screws : Stainless steel (Corrosion-resistant treatment) Dome section : Polycarbonate resin, Clear (G: Smoke) | |

^{*1} Converted value
^{*2} For information on the operation verification of the supported web browsers, refer to our support website <Control No.: CO132>.
^{*3} Used by super resolution techniques
^{*4} Transmission for 4 streams can be individually set.
^{*5} When recording audio on an microSD memory card, only use AAC-LC (Advanced Audio Coding - Low Complexity).

Appearance

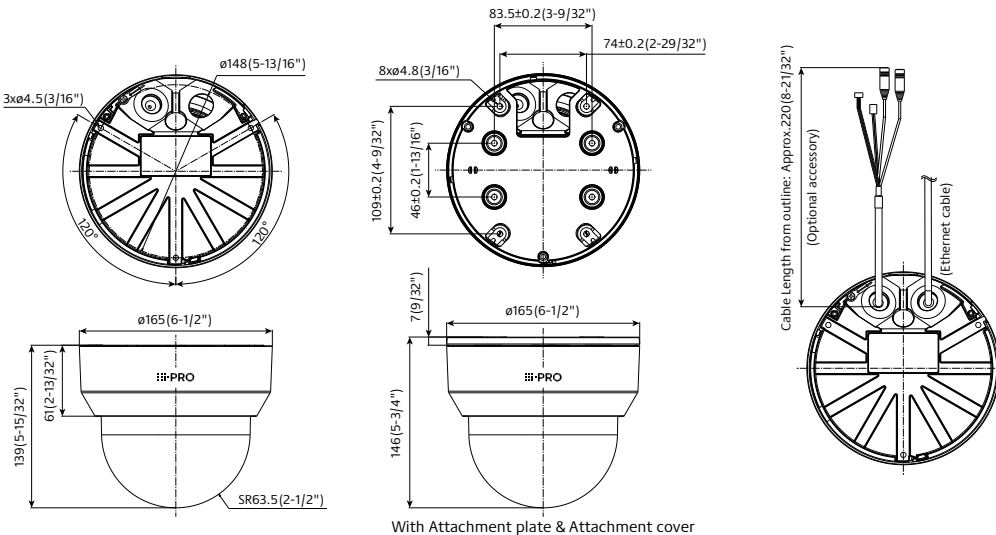













Unit : mm (inches)





With Attachment plate & Attachment cover

Optional Accessories

Mount Bracket / Other

| | WALL | | POLE | CORNER | HANGING | |
|-------------|---|---|---|---|---|---|
| | 1 | 2 | 1 | 1 | 1 | 2 |
| combination | Wall Mount Bracket PWM40W (White)  | Wall Mount Bracket WV-QWL500-W (White)  | Pole Mount Bracket PAPM4W (White)  | Corner Mount Bracket PACA4W (White)  | Ceiling Mount Bracket WV-QCL501-W (White)  | Ceiling Mount Bracket WV-QCL101-W ^{*1} (White)  |
| | Mount Bracket WV-QSR501F1-W (White, ANSI Female thread)  | Adapter Box WV-QJB500-W (White)  <small>*If needed.</small> | Wall Mount Bracket PWM40W (White)  | Wall Mount Bracket PWM40W (White)  | Mount Bracket WV-QSR501-W (White)  | |
| | | | Mount Bracket WV-QSR501F1-W (White, ANSI Female thread)  | Mount Bracket WV-QSR501F1-W (White, ANSI Female thread)  | | |

*1 : It's possible to be used on the camera side and ceiling side. If used on both side, 2pieces are required.

| | CEILING | | | OTHER |
|-------------|--|---|--|--|
| | 1 | 2 | 3 | 1 |
| combination | Base Bracket WV-QJB501-W (White)  | Ceiling Mount Bracket (Embedded) WV-QEM503-W (White)  <small>*For indoor installation only.</small> | Base bracket WV-QJB504-W (White)  | 3rd Party Pipe (Male or Female type) |
| | | | | Mount Bracket WV-QSR501F1-W (White, ANSI Female thread)  WV-QSR501M1-W (White, ANSI Male thread)  |

Dome Cover

Dome Cover (Smoke type)
WV-QDC502G



Cable

I/O Cable
WV-QCA501A
WV-QCA501APK



*WV-QCA501APK is package of 10 cables.
*The color of the grommet rubber may differ depending on the production time, but the performance and mounting method will not change.

Trademarks and registered trademarks

- GlobalSign and the GlobalSign Logo are registered trademarks of GMO GlobalSign K.K.
- iPad and iPhone are trademarks of Apple Inc., registered in the U.S. and other countries.
- Android is a trademark of Google LLC.
- ONVIF is a trademark of ONVIF, Inc.
- All other trademarks identified herein are the property of their respective owners.

Important

- Safety Precautions : Carefully read the Basic Information, Installation Guide and Operating Instructions before using this product.
- i-PRO Co., Ltd. cannot be held responsible for the performance of the network and/or other manufacturers' products used on the network.
- Masses and dimensions are approximate. • Specifications are subject to change without notice.