

S-series PTZ camera with AI Engine

5MP 10x Indoor PTZ Network Camera

S-series models come standard with AI automatic tracking. It can automatically detect, zoom, and track intruders in a wide area, thereby supporting surveillance operators in many scenes. It also achieves the industry's highest level of drive durability to withstand high-speed and high-frequency camera movement by the automatic monitoring function.

AI monitoring camera, standard with AI Auto-tracking

- AI analysis functionality is standard on the camera side to promote automated surveillance. Accurately detects people and vehicles and automatically zooms in on intruders. Support surveillance operators to ensure that no tracked object is missed.
- Additional applications can be installed (up to two applications) to expand analysis functions such as AI privacy guard, person/vehicle attribute detection, etc.

Highly durable pan-tilt drive unit Reduced maintenance costs

- High durability gear drive achieves PAN and TILT drive durability (3.7 million movements). Low failure rate even with high frequency drive and reduced maintenance cost by minimizing the maintenance cycle.

Easy installation

- S-series compact PTZ cameras can be installed discreetly and easily on low ceilings.
- Easy kitting packaging" allows the camera to be set up without removing it from the box during kitting prior to installation.
- The addition of a diverse lineup of mounting brackets and optional PoE injectors enables flexible installation regardless of the location of new or existing installations.

High security standard

- Highest level of security. In addition to digital certificates issued by a third-party organization (GlobalSign®), FIPS 140-2 Level 3 certified EdgeLock® SE050F secure element (NXP® Semiconductors) is embedded.

Key i-PRO Spec.

- 5MP
- 10x optical zoom
- Intelligent Auto (with AI Engine)
- Super Dynamic 132dB
- Color night vision (0.007 to 0.11 lx)
- Durable Pan/Tilt gear mechanism
- ONVIF® Profile G / M / S / T
*ONVIF is a trademark of ONVIF, Inc.
- FIPS 140-2 level 3 certified
*Built-in EdgeLock® SE050F (NXP® Semiconductors)
- NDAA Compliant



Specifications

Camera	Image Sensor	Approx. 1/2.8 type CMOS image sensor		
	Minimum Illumination	Color : 0.11 lx (50IRE, F1.6, 1/30s) Color : 0.007 lx (50IRE, F1.6, 16/30s) ^{*1} BW : 0.06 lx (50IRE, F1.6, 1/30s) BW : 0.004 lx (50IRE, F1.6, 16/30s)		
	White Balance	ATW1 / ATW2 / AWC		
	Shutter Speed	[30 fps/15 fps mode] 1/30 Fix to 1/10000 Fix [25 fps/12.5 fps mode] 1/25 Fix to 1/10000 Fix		
	Intelligent Auto	On / Off		
	Super Dynamic	On / Off. The level can be set in the range of 0 to 31.		
	Dynamic Range	Max.132 dB (Super Dynamic : On, Level 31)		
	Adaptive Black Stretch	The level can be set in the range of 0 to 255.		
	Back light compensation / High light compensation	BLC (Back light compensation) / HLC (High light compensation) / Off The level can be set in the range of 0 to 31 (only when Super dynamic / Intelligent Auto : Off)		
	Fog compensation	On / Off. The level can be set in the range of 0 to 8 (only when Intelligent auto / auto contrast adjust : Off)		
	Maximum gain (AGC)	The level can be set in the range of 0 to 11.		
	Color/BW (ICR)	Off / On / Auto1 / Auto2 / Auto3 (SCC)		
	Digital Noise Reduction	The level can be set in the range of 0 to 255.		
	Video Motion Detection (VMD)	On / Off, 4 areas available		
	Scene Change Detection (SCD)	On / Off, 1 areas available		
	Audio Detection	On / Off		
	AI Sound Classification	Gunshot, Yell, Vehicle horn, Glass break		
	AI Analytics	Yes		
	Privacy Zone	On / Off, Up to 32 zones available		
	VIQS	On / Off, Up to 8 zones available		
Image Stabilizer	On / Off			
Camera Title (OSD)	On / Off, Up to 40 characters (alphanumeric characters, marks)			
Focus Adjustment	Auto focus			
Lens	Optical zoom	10x (Motorized zoom / Motorized Focus)		
	Extra zoom	Max. 15x (10 to 15x : When resolution is 1280 x 720)		
	Focal length	4.7 - 47 mm (3/16 inches - 1-27/32 inches)		
	Angular Field of View	[16 : 9 mode] Horizontal : 6.2° (TELE) - 58° (WIDE), Vertical : 3.5° (TELE) - 34° (WIDE) [4 : 3 mode] Horizontal : 6.2° (TELE) - 58° (WIDE), Vertical : 4.6° (TELE) - 44° (WIDE)		
	Maximum Aperture Ratio	1 : 1.6 (WIDE) - 1 : 3.0 (TELE)		
Focus range	1.5 m (59-1/16 inches) - ∞			
DORI	Detect (25ppm / 8ppf)	Wide: 92.4 m / 110.8 m (303 ft / 363.7 ft), Tele: 94.5 m / 113.4 m (310.6 ft / 372.2 ft)		
	Observe (62.5ppm / 19ppf)	Wide: 36.9 m / 44.3 m (121.2 ft / 145.5 ft), Tele: 37.8 m / 45.3 m (124.0 ft / 148.8 ft)		
	Recognize (125ppm / 38ppf)	Wide: 18.5 m / 22.2 m (60.6 ft / 72.7 ft), Tele: 18.9 m / 22.6 m (62.0 ft / 74.4 ft)		
	Identify (250ppm / 76ppf)	Wide: 9.2 m / 11.1 m (30.3 ft / 36.4 ft), Tele: 94.5 m / 113.4 m (310.2 ft / 372.2 ft)		
System on Chip (SoC)	Ambarella CV22			
Adjusting Angle	Horizontal : 0 to +350°, Vertical : -30 to +90°, Yaw : 0°			
Pan/tilt	Panning Range	0 - +350°		
	Panning Speed	Manual: Approx. 0.065°/s - 150°/s Preset: Up to approx. 350°/s		
	Tilting Range	Operational -30° - +90°		
	Tilting Speed	Manual: Approx. 0.065°/s - 150°/s Preset: Up to approx. 300°/s		
	Preset Positions	256 positions		
	Auto Mode	Auto Track / Auto pan/ Preset sequence/ Patrol		
	Self Return	10 s/ 20 s/ 30 s/ 1 min/ 2 min/ 3 min/ 5 min/ 10 min/ 20 min/ 30 min/ 60 min		
	Camera Control	Brightness, AUX On / Off		
	Browser GUI	Audio	Mic (Line) Input : On / Off Volume adjustment : Low / Middle / High Audio Output : On / Off Volume adjustment : Low / Middle / High	
		GUI / Setup Menu Language	English, Italian, French, German, Spanish, Portuguese, Russian, Chinese, Japanese	
Network	Browser ^{*2}	Microsoft Edge, Firefox, Google Chrome		
	Network IF	10Base-T / 100Base-TX, RJ45 connector		
	Resolution	[16 : 9 mode (30 fps mode)], [16 : 9 mode (25 fps mode)] 3072x1728 ³ , 2560x1440, 1920x1080, 1280x720, 640x360, 320x180 [4 : 3 mode (30 fps mode)], [4 : 3 mode (25 fps mode)] 3072x2304 ³ , 2560x1920, 1280x960, 800x600, VGA, 400x300, 320x240		
	H.265 / H.264 ⁴ JPEG (MJPEG)	Constant bit rate / VBR / Frame rate / Best effort		
	H.265 / H.264 ⁴ Transmission Type	Unicast port (AUTO) / Unicast port (MANUAL) / Multicast		
	JPEG Image Quality	10 steps		

Network	Smart Coding	GOP (Group of pictures) control: Off / Low (Variable GOP 1s-8s) / Mid (Variable GOP 4s-16s) / Advanced (Fixed GOP 60s w/1s key-frame) / Frame rate control (Variable GOP 4s-16s with frame rate control) *Advanced and Frame rate control are only available with H.265. Smart Coding: Auto VIQS: On/Off
	Audio Compression	G.726 (ADPCM) : 16 kbps / 32 kbps G.711 : 64 kbps AAC-LC ⁵ : 64 kbps / 96 kbps / 128 kbps
	Audio transmission mode	Off / Mic (Line) input / Audio output / Interactive (Half duplex) / Interactive (Full duplex)
	Supported Protocol	IPv6 : TCP/IP, UDP/IP, HTTP, HTTPS, SSL/TLS, SMTP, DNS, NTP, SNMPv1/v2/v3, DHCPv6, RTP, MLD, ICMP, ARP, IEEE 802.1X, DiffServ, SFTP, MQTT, LLDP IPv4 : TCP/IP, UDP/IP, HTTP, HTTPS, SSL/TLS, RTSP, RTP, RTP/RTCP, SMTP, DHCP, DNS, DDNS, NTP, SNMPv1/v2/v3, UPnP, IGMP, ICMP, ARP, IEEE 802.1X, DiffServ, SRTP, SFTP, MQTT, NTCP
	No. of Simultaneous Users	Up to 14 users (Depends on network conditions)
	Secure	FIPS 140-2 level 3 (NXP® EdgeLock® SE050F), Device Certificate GlobalSign® pre-installed, User authentication, Host authentication, HTTPS, Data encryption, 802.1X Support
	SDXC/SDHC/SD Memory Card	H.265 / H.264 recording : Manual REC / Alarm REC (Pre/Post) / Schedule REC / Backup upon network failure JPEG recording : Manual REC / Alarm REC (Pre/Post) / Backup upon network failure Compatible SDXC/SDHC/SD Memory Card : microSDXC memory card : 64 GB, 128 GB, 256 GB, 512 GB microSDHC memory card : 4 GB, 8 GB, 16 GB, 32 GB microSD memory card : 2 GB
	Mobile Terminal Compatibility	iPad, iPhone (iOS 8.0 or later), Android™ terminals
	ONVIF® Profile	G / M / S / T
	Alarm	Alarm Source
Alarm Actions		SDXC/SDHC/SD memory recording, E-mail notification, HTTP alarm notification indication on browser, TCP alarm notification output
Input/Output	Audio input	ø3.5 mm stereo mini jack
	For microphone input :	Recommended applicable microphone : Plug-in power type (Sensitivity of microphone : -51 dB to -38 dB (0 dB=1 V/Pa, 1 kHz)) Input impedance : Approx. 2 kΩ (unbalanced) Supply voltage : 2.5 V ±0.5 V For line input : Input level : Approx. -10 dBV
	Audio Output	ø3.5 mm stereo mini jack (monaural output) Output impedance : Approx. 600 Ω (unbalanced) Output level : -20 dBV
	External I/O Terminals	ALARM IN 1 (Alarm input 1/ Black & white input/ Auto time adjustment input) (x1) ALARM IN 2 (Alarm input 2/ ALARM OUT) (x1), ALARM IN 3 (Alarm input 3/ AUX OUT) (x1) UL (UL62368-1), c-UL (CSA C22.2 No. 62368-1), CE, IEC62368-1
General	Safety	FCC (Part15 ClassA), ICES-003 Issue 7 ClassA, EN55032 ClassA, EN55035
	EMC	UL (UL62368-1), c-UL (CSA C22.2 No. 62368-1), CE, IEC62368-1
	Power Source and Power Consumption	DC12 V, PoE (IEEE802.3af) DC12 V: 970 mA / Approx. 11.6 W PoE DC 48 V: 270 mA / Approx. 12.95 W (Class 0 device)
	Ambient Operating Temperature	-10 °C to +50 °C (+14 °F to +122 °F) (Power On range : 0 °C to +50 °C (+32 °F to +122 °F))
	Ambient Operating Humidity	10 to 90 % (no condensation)
	Anti-Condensation System	—
	Dimensions	ø117 mm x 155 mm (H) (ø4-19/32 inches x 6-3/32 inches (H))
	Mass (approx.)	Approx. 1.2 kg (2.65 lbs)
Finish	Main body : Resin, I-PRO white	

*1 Converted value

*2 For information on the operation verification of the supported web browsers, refer to our support website <Control No.: C0132>.

*3 Used by super resolution techniques

*4 Transmission for 4 streams can be individually set.

*5 When recording audio on an microSD memory card, only use AAC-LC (Advanced Audio Coding - Low Complexity).

Appearance

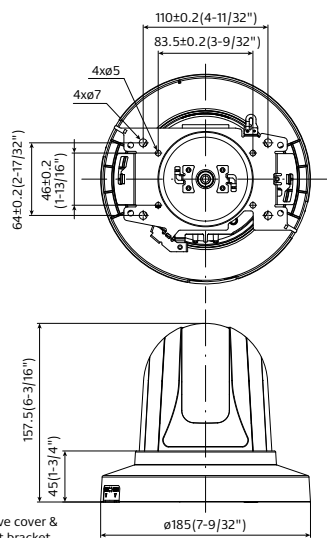



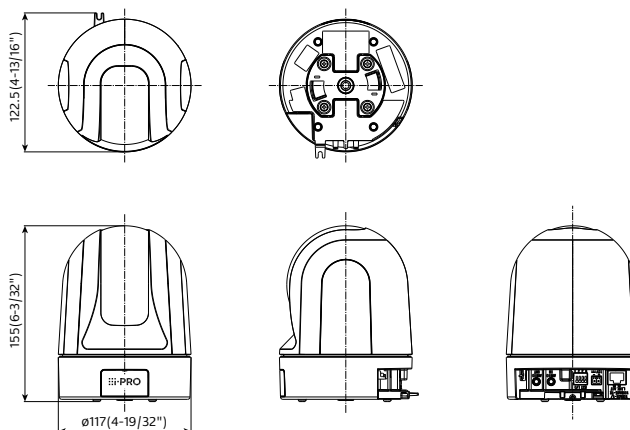





With Decorative cover & Camera mount bracket





Unit : mm (inches)

Optional Accessories

Mount Bracket / Other

		WALL		POLE	CORNER	HANGING
		1	2	1	1	1
combination	Wall Mount Brackets WV-QWD100G-W (Smoke) WV-QWD100C-W (Clear) (i-PRO white)	Wall Mount Bracket WV-QWL500-W (i-PRO white)	Pole Mount Bracket WV-QPL500-W (i-PRO white)	Corner Mount Bracket WV-QCN500-W (i-PRO white)	Ceiling Mount Bracket WV-QCL100-W *1 (i-PRO white)	
						
	Adapter Box WV-QJB500-W (i-PRO white)	Wall Mount Brackets WV-QWD100G-W (Smoke) WV-QWD100C-W (Clear) (i-PRO white)	Wall Mount Brackets WV-QWD100G-W (Smoke) WV-QWD100C-W (Clear) (i-PRO white)	Wall Mount Brackets WV-QWD100G-W (Smoke) WV-QWD100C-W (Clear) (i-PRO white)		
						

*1: It's possible to be used on the camera side and ceiling side. If used on both side, 2pieces are required.

		CEILING		
		1	2	3
combination	Ceiling Mount Brackets WV-QED100G-W (Smoke) WV-QED100C-W (Clear) (i-PRO white)	Ceiling Mount Brackets WV-QCD100G-W (Smoke) WV-QCD100C-W (Clear) (i-PRO white)	Ceiling Mount Bracket WV-Q105A (Silver)	
				

Inner Cover



Trademarks and registered trademarks

- GlobalSign and the GlobalSign Logo are registered trademarks of GMO GlobalSign K.K.
- iPad and iPhone are trademarks of Apple Inc., registered in the U.S. and other countries.
- Android is a trademark of Google LLC.
- ONVIF is a trademark of ONVIF, Inc.
- All other trademarks identified herein are the property of their respective owners.

Important

- Safety Precautions : Carefully read the Basic Information, Installation Guide and Operating Instructions before using this product.
- i-PRO Co., Ltd. cannot be held responsible for the performance of the network and/or other manufacturers' products used on the network.
- Masses and dimensions are approximate. • Specifications are subject to change without notice.