

U series PTZ camera

2MP (1080p) 10x Indoor PTZ Network Camera

U-Series launch gives customers PTZ's that meet top security certifications (FIPS 140-2 level 3) while also providing a unique blend of imaging performance, reliability and affordability.

Highly durable pan-tilt drive unit Reduced maintenance costs

- High durability gear drive achieves PAN and TILT drive durability (3.7 million movements). Low failure rate even with high frequency drive and reduced maintenance cost by minimizing the maintenance cycle.

Easy installation

- U-series compact PTZ cameras can be installed discreetly and easily on low ceilings.
- Easy kitting packaging" allows the camera to be set up without removing it from the box during kitting prior to installation.
- The addition of a diverse lineup of mounting brackets and optional PoE injectors enables flexible installation regardless of the location of new or existing installations.

High security standard

- Highest level of security. In addition to digital certificates issued by a third-party organization (GlobalSign®), FIPS 140-2 level3-certified hardware is installed.

Key i-PRO Spec.

- 2MP (1080p) 1920x1080
- 10x optical zoom
- Intelligent Auto
- Super Dynamic 144dB
- Color night vision (0.001 to 0.015 lx)
- Durable Pan/Tilt gear mechanism
- ONVIF® Profile G / S / T
- *ONVIF is a trademark of ONVIF, Inc.
- FIPS 140-2 level3 certified

Industry examples

- Retail (Shopping mall) / Logistics
- Transportation (Airport / Train, Subway station)
- Bank
- Building



Specifications

Camera	Image Sensor	Approx. 1/2.8 type CMOS image sensor	
	Minimum Illumination	Color : 0.015 lx (50IRE, F1.6, 1/30s) Color : 0.001 lx (50IRE, F1.6, 16/30s)*1 BW : 0.006 lx (50IRE, F1.6, 1/30s) BW : 0.0004 lx (50IRE, F1.6, 16/30s)	
	White Balance	ATW1 / ATW2 / AWC	
	Shutter Speed	[60 fps Mode] 1/60 Fix to 1/10000 Fix, [30 fps/15 fps mode] 1/30 Fix to 1/10000 Fix [50 fps Mode] 1/50 Fix to 1/10000 Fix, [25 fps/12.5 fps mode] 1/25 Fix to 1/10000 Fix	
	Intelligent Auto	On / Off	
	Super Dynamic*2	On / Off, The level can be set in the range of 0 to 31.	
	Dynamic Range	Max.144 dB (Super Dynamic : On, Level 3)	
	Adaptive Black Stretch	The level can be set in the range of 0 to 255.	
	Back light compensation / High light compensation	BLC (Back light compensation) / HLC (High light compensation) / Off The level can be set in the range of 0 to 31 (only when Super dynamic / Intelligent Auto : Off)	
	Fog compensation	On / Off, The level can be set in the range of 0 to 8 (only when intelligent auto / auto contrast adjust : Off)	
	Maximum gain (AGC)	The level can be set in the range of 0 to 11.	
	Color/BW (ICR)	Off / On / Auto1 / Auto2 / Auto3 (SCC)	
	Digital Noise Reduction	The level can be set in the range of 0 to 255.	
	Video Motion Detection (VMD)	On / Off, 4 areas available	
	Scene Change Detection (SCD)	On / Off, 1 areas available	
	Audio Detection	On / Off	
	AI Sound Classification	—	
	AI Analytics	—	
	Privacy Zone	On / Off, Up to 32 zones available	
	VIQS	On / Off, Up to 8 zones available	
Image Stabilizer	On / Off		
Camera Title (OSD)	On / Off, Up to 40 characters (alphanumeric characters, marks)		
Focus Adjustment	Auto focus		
Lens	Optical zoom	10x (Motorized zoom / Motorized Focus)	
	Extra zoom	Max. 15x (10 to 15x : When resolution is 1280 x 720)	
	Focal length	4.7 – 47 mm (3/16 inches – 1.27/32 inches)	
	Angular Field of View	[16 : 9 mode] Horizontal : 6.7° (TELE) – 62° (WIDE), Vertical : 3.8° (TELE) – 37° (WIDE) [4 : 3 mode] Horizontal : 5.1° (TELE) – 48° (WIDE), Vertical : 3.8° (TELE) – 37° (WIDE)	
	Maximum Aperture Ratio	1 : 1.6 (WIDE) – 1 : 3.0 (TELE)	
DORI	Detect (25ppm / 8ppf)	Wide: 64.2 m / 210.5 ft, Tele: 656.0 m / 2152.3 ft	
	Observe (62.5ppm / 19ppf)	Wide: 25.7 m / 84.2 ft, Tele: 262.4 m / 860.9 ft	
	Recognize (125ppm / 38ppf)	Wide: 12.8 m / 42.1 ft, Tele: 131.2 m / 430.5 ft	
	Identify (250ppm / 76ppf)	Wide: 6.4 m / 21.1 ft, Tele: 65.6 m / 215.2 ft	
System on Chip (SoC)		Ambarella CV25M	
Adjusting Angle		Horizontal : 0 to +350°, Vertical : -30 to +90°, Yaw : 0°	
Pan/tilt	Panning Range	0 – +350°	
	Panning Speed	Manual: Approx. 0.065°/s – 150°/s Preset: Up to approx. 500°/s	
	Tilting Range	Operational -30° – +90°	
	Tilting Speed	Manual: Approx. 0.065°/s – 150°/s Preset: Up to approx. 350°/s	
	Preset Positions	256 positions	
	Auto Mode	Auto pan/ Preset sequence/ Patrol	
	Self Return	10 s/ 20 s/ 30 s/ 1 min/ 2 min/ 3 min/ 5 min/ 10 min/ 20 min/ 30 min/ 60 min	
	Browser GUI	Camera Control	Brightness, AUX On / Off
	Audio	Mic (Line) Input : On / Off Volume adjustment : Low / Middle / High Audio Output : On / Off Volume adjustment : Low / Middle / High	
	GUI / Setup Menu Language	English, Italian, French, German, Spanish, Portuguese, Russian, Chinese, Japanese	
	Browser*3	Microsoft Edge, Firefox, Google Chrome	
Network	Network IF	10Base-T / 100Base-TX, RJ45 connector	
	Resolution	[16 : 9 mode (60 fps mode)] *2, [16 : 9 mode (30 fps mode)] , [16 : 9 mode (50 fps mode)] *2, [16 : 9 mode (25 fps mode)] 1920x1080, 1280x720, 640x360, 320x180 [4 : 3 mode (30 fps mode)] , [4 : 3 mode (25 fps mode)] 1280x960, VGA, QVGA [4 : 3 mode (15 fps mode)] , [4 : 3 mode (12.5 fps mode)] 2048x1536*4, 1280x960, VGA, QVGA	
	H.265/	Transmission Mode	Constant bit rate / VBR / Frame rate / Best effort
	H.264*5	Transmission Type	Unicast port (AUTO) / Unicast port (MANUAL) / Multicast
	JPEG	Image Quality	10 steps

Network	Smart Coding	GOP (Group of pictures) control: Off / Low (Variable GOP 1s-8s) / Mid (Variable GOP 4s-16s) / Advanced (Fixed GOP 60s w/1s key-frame) / Frame rate control (Variable GOP 4s-16s with frame rate control) *Advanced and Frame rate control are only available with H.265. Smart Coding: Auto VIQS: On/Off
	Audio Compression	G.726 (ADPCM) : 16 kbps / 32 kbps G.711 : 64 kbps AAC-LC*6 : 64 kbps / 96 kbps / 128 kbps
	Audio transmission mode	Off / Mic (Line) input / Audio output / Interactive (Half duplex) / Interactive (Full duplex)
	Supported Protocol	IPv6 : TCP/IP, UDP/IP, HTTP, HTTPS, SSL/TLS, SMTP, DNS, NTP, SNMPv1/v2/v3, DHCPv6, RTP, MLD, ICMP, ARP, IEEE 802.1X, DiffServ, SFTP, MQTT, LLDP IPv4 : TCP/IP, UDP/IP, HTTP, HTTPS, SSL/TLS, RTSP, RTP, RTCP/RTCP, SMTP, DHCP, DNS, DDNS, NTP, SNMPv1/v2/v3, UPnP, IGMP, ICMP, ARP, IEEE 802.1X, DiffServ, SRTP, SFTP, MQTT, NTCP
	No. of Simultaneous Users	Up to 14 users (Depends on network conditions)
	Secure	FIPS 140-2 level3, Device Certificate GlobalSign® pre-installed
	SDXC/SDHC/SD Memory Card	H.265 / H.264 recording : Manual REC / Alarm REC (Pre/Post) / Schedule REC / Backup upon network failure JPEG recording : Manual REC / Alarm REC (Pre/Post) / Backup upon network failure Compatible SDXC/SDHC/SD Memory Card : microSDXC memory card : 64 GB, 128 GB, 256 GB, 512 GB microSDHC memory card : 4 GB, 8 GB, 16 GB, 32 GB microSD memory card : 2 GB
	Mobile Terminal Compatibility	iPad, iPhone (iOS 8.0 or later), Android™ terminals
	ONVIF® Profile	G / S / T
	Alarm	Alarm Source
Alarm Actions		SDXC/SDHC/SD memory recording, E-mail notification, HTTP alarm notification Indication on browser, TCP alarm notification output
Input/ Output	Audio input	Ø3.5 mm stereo mini jack For microphone input : Recommended applicable microphone : Plug-in power type (Sensitivity of microphone : -51 dB to -38 dB (0 dB=1 V/Pa, 1 kHz)) Input impedance : Approx. 2 kΩ (unbalanced) Supply voltage : 2.5 V ±0.5 V
	Audio Output	For line input : Input level : Approx. -10 dBV Ø3.5 mm stereo mini jack (monaural output) Output impedance : Approx. 600 Ω (unbalanced) Output level : -20 dBV
General	External I/O Terminals	ALARM IN 1 (Alarm input 1/ Black & white input/ Auto time adjustment input) (x1) ALARM IN 2 (Alarm input 2/ ALARM OUT) (x1), ALARM IN 3 (Alarm input 3/ AUX OUT) (x1)
	Safety	UL (UL62368-1), c-UL (CSA C22.2 No.62368-1), CE, IEC62368-1
EMC	Power Source and Power Consumption	FCC (Part15 ClassA), ICES-003 Issue 7 ClassA, EN55032 ClassA, EN55035 DC12 V, PoE (IEEE802.3af) DC12 V: 970 mA / Approx. 11.6 W PoE DC 48 V: 270 mA / Approx.12.95 W (Class 0 device)
	Ambient Operating Temperature	-10 °C to +50 °C (+14 °F to +122 °F) (Power On range : 0 °C to +50 °C (+32 °F to +122 °F))
	Ambient Operating Humidity	10 to 90 % (no condensation)
	Anti-Condensation System	—
	Dimensions	Ø117 mm x 155 mm (H) {Ø4-19/32 inches x 6-3/32 inches (H)}
	Mass (approx.)	Approx. 1.2 kg {2.65 lbs}
	Finish	Main body : Resin, i-PRO white

*1 Converted value

*2 When 60 fps or 50 fps is selected, the Super Dynamic function is automatically set to off.

*3 For information on the operation verification of the supported web browsers, refer to our support website <Control No.: C0132>.

*4 Used by super resolution techniques

*5 Transmission for 4 streams can be individually set.

*6 When recording audio on an microSD memory card, only use AAC-LC (Advanced Audio Coding - Low Complexity).



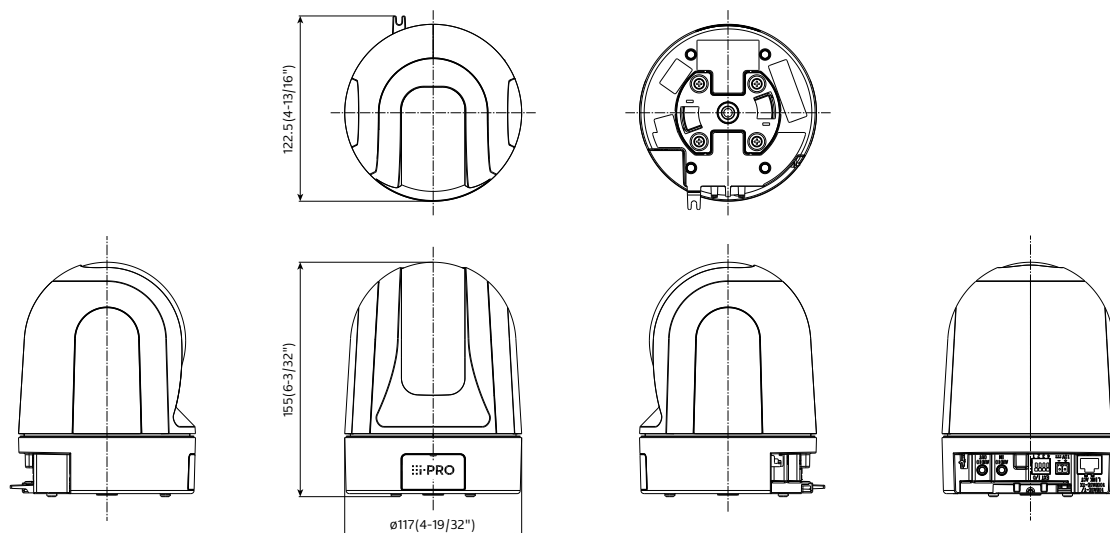





Appearance





Unit : mm (inches)

Optional Accessories

Mount Bracket / Other

		WALL		POLE	CORNER	HANGING
		1	2	1	1	1
combination	Wall Mount Brackets WV-QWD100G-W (Smoke) WV-QWD100C-W (Clear) (i-PRO white)	Wall Mount Bracket WV-QWL500-W (i-PRO white)	Pole Mount Bracket WV-QPL500-W (i-PRO white)	Corner Mount Bracket WV-QCN500-W (i-PRO white)	Ceiling Mount Bracket WV-QCL100-W *1 (i-PRO white)	
						
	Adapter Box WV-QJB500-W (i-PRO white)	Wall Mount Brackets WV-QWD100G-W (Smoke) WV-QWD100C-W (Clear) (i-PRO white)	Wall Mount Brackets WV-QWD100G-W (Smoke) WV-QWD100C-W (Clear) (i-PRO white)	Wall Mount Brackets WV-QWD100G-W (Smoke) WV-QWD100C-W (Clear) (i-PRO white)		
						

*1: It's possible to be used on the camera side and ceiling side. If used on both side, 2pieces are required.

		CEILING		
		1	2	3
combination	Ceiling Mount Brackets WV-QED100G-W (Smoke) WV-QED100C-W (Clear) (i-PRO white)	Ceiling Mount Brackets WV-QCD100G-W (Smoke) WV-QCD100C-W (Clear) (i-PRO white)	Ceiling Mount Bracket WV-Q105A (Silver)	
				

Inner Cover



Trademarks and registered trademarks

- GlobalSign and the GlobalSign Logo are registered trademarks of GMO GlobalSign K.K.
- iPad and iPhone are trademarks of Apple Inc., registered in the U.S. and other countries.
- Android is a trademark of Google LLC.
- ONVIF is a trademark of ONVIF, Inc.
- All other trademarks identified herein are the property of their respective owners.

Important

- Safety Precautions : Carefully read the Basic Information, Installation Guide and Operating Instructions before using this product.
- i-PRO Co., Ltd. cannot be held responsible for the performance of the network and/or other manufacturers' products used on the network.
- Masses and dimensions are approximate. • Specifications are subject to change without notice.