

## S series PTZ camera with AI

# 2MP (1080p) 21x Indoor PTZ Network Camera

S series models come standard with AI automatic tracking. It can automatically detect, zoom, and track intruders in a wide area, thereby supporting surveillance operators in many scenes. It also achieves the industry's highest level of drive durability to withstand high-speed and high-frequency camera movement by the automatic monitoring function.

### AI monitoring camera, standard with AI Auto-tracking

- AI analysis functionality is standard on the camera side to promote automated surveillance. Accurately detects people and vehicles and automatically zooms in on intruders. Support surveillance operators to ensure that no tracked object is missed.
- Additional applications can be installed (up to two applications) to expand analysis functions such as AI privacy guard, person/vehicle attribute detection, etc.

### Highly durable pan-tilt drive unit Reduced maintenance costs

- High durability gear drive achieves PAN and TILT drive durability (3.7 million movements). Low failure rate even with high frequency drive by automatic tracking function and reduced maintenance cost by minimizing the maintenance cycle.

### Easy installation

- S-series compact PTZ cameras can be installed discreetly and easily on low ceilings.
- Easy kitting packaging allows the camera to be set up without removing it from the box during kitting prior to installation.
- The addition of a diverse lineup of mounting brackets and optional PoE injectors enables flexible installation regardless of the location of new or existing installations.

### High security standard

- Highest level of security. In addition to digital certificates issued by a third-party organization (GlobalSign®), FIPS 140-2 level3-certified hardware is installed.

### Key i-PRO Spec.

- 2MP (1080p) 1920x1080
- 21x optical zoom
- Intelligent Auto (with AI Engine)
- Super Dynamic 144dB
- Color night vision (0.001 to 0.015 lx)
- Durable Pan/Tilt gear mechanism
- ONVIF® Profile G / M / S / T
- \*ONVIF is a trademark of ONVIF, Inc.
- FIPS 140-2 level3 certified

### Industry examples

- Retail (Shopping mall) / Logistics
- Transportation (Airport / Train, Subway station)
- Bank
- Building



## Specifications

<b>Camera</b>	Image Sensor	Approx. 1/2.8 type CMOS image sensor	
	Minimum Illumination	Color : 0.015 lx (50IRE, F1.6, 1/30s) Color : 0.001 lx (50IRE, F1.6, 16/30s)*1 BW : 0.006 lx (50IRE, F1.6, 1/30s) BW : 0.0004 lx (50IRE, F1.6, 16/30s)	
	White Balance	ATW1 / ATW2 / AWC	
	Shutter Speed	[60 fps Mode] 1/60 Fix to 1/10000 Fix, [30 fps/15 fps mode] 1/30 Fix to 1/10000 Fix [50 fps Mode] 1/50 Fix to 1/10000 Fix, [25 fps/12.5 fps mode] 1/25 Fix to 1/10000 Fix	
	Intelligent Auto	On / Off	
	Super Dynamic*2	On / Off, The level can be set in the range of 0 to 31.	
	Dynamic Range	Max.144 dB (Super Dynamic : On, Level 31)	
	Adaptive Black Stretch	The level can be set in the range of 0 to 255.	
	Back light compensation / High light compensation	BLC (Back light compensation) / HLC (High light compensation) / Off The level can be set in the range of 0 to 31 (only when Super dynamic / Intelligent Auto : Off)	
	Fog compensation	On / Off, The level can be set in the range of 0 to 8 (only when intelligent auto / auto contrast adjust : Off)	
	Maximum gain (AGC)	The level can be set in the range of 0 to 11.	
	Color/BW (ICR)	Off / On / Auto1 / Auto2 / Auto3 (SCC)	
	Digital Noise Reduction	The level can be set in the range of 0 to 255.	
	Video Motion Detection (VMD)	On / Off, 4 areas available	
	Scene Change Detection (SCD)	On / Off, 1 areas available	
	Audio Detection	On / Off	
	AI Sound Classification	Gunshot, Yell, Vehicle horn, Glass break	
	AI Analytics	Yes	
	Privacy Zone	On / Off, Up to 32 zones available	
	VIQS	On / Off, Up to 8 zones available	
Image Stabilizer	On / Off		
Camera Title (OSD)	On / Off, Up to 40 characters (alphanumeric characters, marks)		
Focus Adjustment	Auto focus		
<b>Lens</b>	Optical zoom	21x (Motorized zoom / Motorized Focus)	
	Extra zoom	Max. 31x (21 to 31x : When resolution is 1280 x 720)	
	Focal length	4.0 - 84.6 mm [5/32 inches - 3-11/32 inches]	
	Angular Field of View	<b>[16 : 9 mode]</b> Horizontal : 3.7° (TELE) - 77° (WIDE), Vertical : 2.2° (TELE) - 44° (WIDE) <b>[ 4 : 3 mode]</b> Horizontal : 2.8° (TELE) - 58° (WIDE), Vertical : 2.2° (TELE) - 44° (WIDE)	
Maximum Aperture Ratio	1 : 1.6 (WIDE) - 1 : 4.5 (TELE)		
Focus range	1.5 m (59-1/16 inches) - ∞		
<b>DORI</b>	Detect (25ppm / 8ppf)	Wide: 51.9 m / 170.3 ft, Tele: 1293.8 m / 4244.9 ft	
	Observe (62.5ppm / 19ppf)	Wide: 20.8 m / 68.1 ft, Tele: 517.5 m / 1697.9 ft	
	Recognize (125ppm / 38ppf)	Wide: 10.4 m / 34.1 ft, Tele: 258.8 m / 849.0 ft	
	Identify (250ppm / 76ppf)	Wide: 5.2 m / 17.0 ft, Tele: 129.4 m / 424.5 ft	
<b>System on Chip (SoC)</b>	Ambarella CV25M		
<b>Adjusting Angle</b>	Horizontal : 0 to +350°, Vertical : -30 to +90°, Yaw : 0°		
<b>Pan/tilt</b>	Panning Range	0 - +350°	
	Panning Speed	Manual: Approx. 0.065°/s - 150°/s Preset: Up to approx. 500°/s	
	Tilting Range	Operational -30 - +90°	
	Tilting Speed	Manual: Approx. 0.065°/s - 150°/s Preset: Up to approx. 350°/s	
	Preset Positions	256 positions	
	Auto Mode	Auto track/ Auto pan/ Preset sequence/ Patrol	
	Self Return	10 s/ 20 s/ 30 s/ 1 min/ 2 min/ 3 min/ 5 min/ 10 min/ 20 min/ 30 min/ 60 min	
	<b>Browser GUI</b>	Camera Control	Brightness, AUX On / Off
Audio	Mic (Line) Input : On / Off Volume adjustment : Low / Middle / High Audio Output : On / Off Volume adjustment : Low / Middle / High		
GUI / Setup Menu Language	English, Italian, French, German, Spanish, Portuguese, Russian, Chinese, Japanese		
Browser*3	Microsoft Edge, Firefox, Google Chrome		
<b>Network</b>	Network IF	10Base-T / 100Base-TX, RJ45 connector	
	Resolution	<b>[16 : 9 mode (60 fps mode)]</b> *2, <b>[16 : 9 mode (30 fps mode)]</b> , <b>[16 : 9 mode (50 fps mode)]</b> *2, <b>[16 : 9 mode (25 fps mode)]</b> 1920x1080, 1280x720, 640x360, 320x180 <b>[4 : 3 mode (30 fps mode)]</b> , <b>[4 : 3 mode (25 fps mode)]</b> 1280x960, VGA, QVGA <b>[4 : 3 mode (15 fps mode)]</b> , <b>[4 : 3 mode (12.5 fps mode)]</b> 2048x1536*4, 1280x960, VGA, QVGA	
	H.265/	Transmission Mode Constant bit rate / VBR / Frame rate / Best effort	
	H.264*5	Transmission Type Unicast port (AUTO) / Unicast port (MANUAL) / Multicast	
	JPEG	Image Quality 10 steps	

<b>Network</b>	Smart Coding	<b>GOP (Group of pictures) control:</b> Off / Low (Variable GOP 1s-8s) / Mid (Variable GOP 4s-16s) / Advanced (Fixed GOP 60s w/1s key-frame) / Frame rate control (Variable GOP 4s-16s with frame rate control) *Advanced and Frame rate control are only available with H.265. <b>Smart VIQS:</b> On(High)/On(Low)/Off, <b>Smart P-picture control:</b> On/Off
	Audio Compression	G.726 (ADPCM) : 16 kbps / 32 kbps G.711 : 64 kbps AAC-LC*6 : 64 kbps / 96 kbps / 128 kbps
	Audio transmission mode	Off / Mic (Line) input / Audio output / Interactive (Half duplex) / Interactive (Full duplex)
	Supported Protocol	IPv6 : TCP/IP, UDP/IP, HTTP, HTTPS, SSL/TLS, SMTP, DNS, NTP, SNMPv1/v2/v3, DHCPv6, RTP, MLD, ICMP, ARP, IEEE 802.1X, DiffServ IPv4 : TCP/IP, UDP/IP, HTTP, HTTPS, SSL/TLS, RTSP, RTP, RTSP/RTCP, SMTP, DHCP, DNS, DDNS, NTP, SNMPv1/v2/v3, UPnP, IGMP, ICMP, ARP, IEEE 802.1X, DiffServ, SRTP, MQTT, NTCP
	No. of Simultaneous Users	Up to 14 users (Depends on network conditions)
	Secure	FIPS 140-2 level3, Device Certificate GlobalSign® pre-installed
	SDXC/SDHC/SD Memory Card	H.265 / H.264 recording : Manual REC / Alarm REC (Pre/Post) / Schedule REC / Backup upon network failure JPEG recording : Manual REC / Alarm REC (Pre/Post) / Backup upon network failure Compatible SDXC/SDHC/SD Memory Card : microSDXC memory card : 64 GB, 128 GB, 256 GB, 512 GB microSDHC memory card : 4 GB, 8 GB, 16 GB, 32 GB microSD memory card : 2 GB
	Mobile Terminal Compatibility	iPad, iPhone (iOS 8.0 or later), Android™ terminals
	ONVIF® Profile	G / M / S / T
	<b>Alarm</b>	Alarm Source
Alarm Actions		SDXC/SDHC/SD memory recording, E-mail notification, HTTP alarm notification Indication on browser, TCP alarm notification output
<b>Input/ Output</b>	Audio input	Ø3.5 mm stereo mini jack For microphone input : Recommended applicable microphone : Plug-in power type (Sensitivity of microphone : -51 dB to -38 dB (0 dB=1V/Pa, 1 kHz)) Input impedance : Approx. 2 kΩ (unbalanced) Supply voltage : 2.5 V ±0.5 V For line input : Input level : Approx. -10 dBV
	Audio Output	Ø3.5 mm stereo mini jack (monaural output) Output impedance : Approx. 600 Ω (unbalanced) Output level : -20 dBV
<b>General</b>	External I/O Terminals	ALARM IN 1 (Alarm input 1/ Black & white input/ Auto time adjustment input) (x1) ALARM IN 2 (Alarm input 2/ ALARM OUT) (x1), ALARM IN 3 (Alarm input 3/ AUX OUT) (x1)
	Safety	UL (UL62368-1), c-UL (CSA C22.2 No.62368-1), CE, IEC62368-1
EMC	FCC (Part15 ClassA), ICES-003 Issue 7 ClassA, EN55032 ClassA, EN55035	
Power Source and Power Consumption	DC12 V, PoE (IEEE802.3af) DC12 V: 970 mA / Approx. 11.6 W PoE DC 48 V: 270 mA / Approx.12.95 W (Class Odevice)	
Ambient Operating Temperature	-10 °C to +50 °C (+14 °F to +122 °F) (Power On range : 0 °C to +50 °C (+32 °F to +122 °F))	
Ambient Operating Humidity	10 to 90 % (no condensation)	
Anti-Condensation System	—	
Dimensions	Ø117 mm x 155 mm (H) [Ø4-19/32 inches x 6-3/32 inches (H)]	
Mass (approx.)	Approx. 1.2 kg [2.65 lbs.]	
Finish	Main body : Resin, i-PRO white	

\*1 Converted value

\*2 When 60 fps or 50 fps is selected, the Super Dynamic function is automatically set to off.

\*3 For information on the operation verification of the supported web browsers, refer to our support website <Control No.: C0132>.

\*4 Used by super resolution techniques

\*5 Transmission for 4 streams can be individually set.

\*6 When recording audio on an microSD memory card, only use AAC-LC (Advanced Audio Coding - Low Complexity).

## Appearance

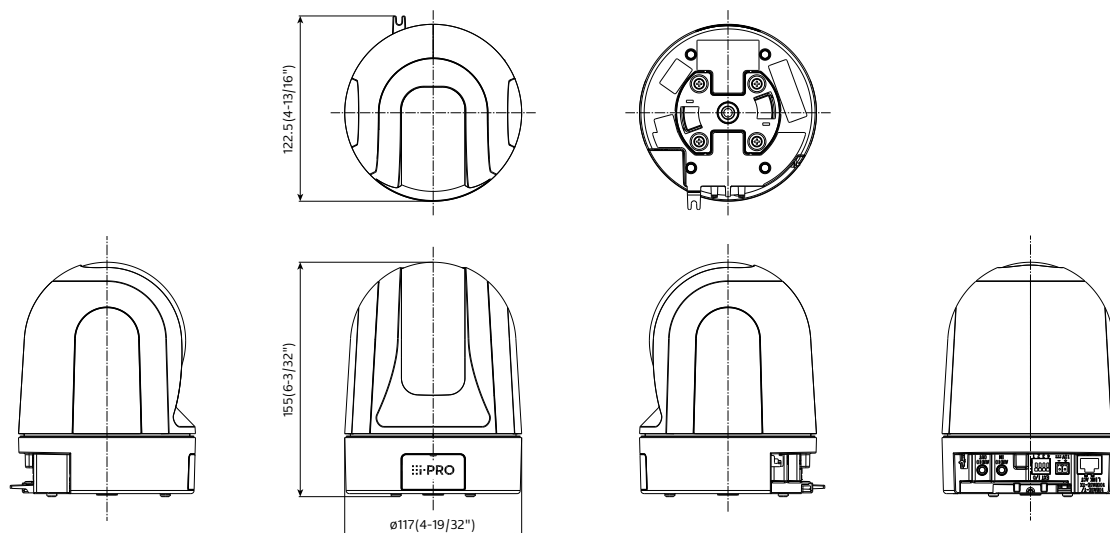

Unit : mm (inches)

## AI Analytics applications

<https://i-pro.com/global/en/surveillance/products/i-pro-ai-application>

### AI Video Motion Detection (AI-VMD)

Advanced video analysis technology detects objects (faces, people, cars, motorcycles) in a specified area. (Intruder Detection, Loitering Detection, Direction Detection, Cross Line Detection)

### AI Privacy Guard

To protect privacy and portrait rights, it is possible to automatically apply a mosaic the entire face and figure of a person photographed by the camera.

### AI Face Detection

Detects faces with high precision even in low-light, backlit, and mask-wearing environments.

### AI People Detection

Extract the characteristics of human face / clothing and classify them into meaningful categories such as gender, age, and clothing color.

### AI Vehicle Detection

Extract vehicle characteristics and classify them into meaningful categories such as type and color.

### AI Non mask Detection

Deep-learning and proprietary image processing technologies recognize mask and detect people who are not wearing them.

### AI Occupancy Detection









Detecting the congestion via network camera with AI engine enables that information to be used direct visitors in advance or help store staff work more efficiently.

3rd party applications are also available.



<https://i-pro.com/global/en/surveillance/i-pro-application-platform/application-list>

## Optional Accessories

### Mount Bracket / Other

	WALL		POLE	CORNER	HANGING
	1	2	1	1	1
combination	Wall Mount Brackets <b>WV-QWD100G-W</b> (Smoke) <b>WV-QWD100C-W</b> (Clear) (i-PRO white) 	Wall Mount Bracket <b>WV-QWL500-W</b> (i-PRO white) 	Pole Mount Bracket <b>WV-QPL500-W</b> (i-PRO white) 	Corner Mount Bracket <b>WV-QCN500-W</b> (i-PRO white) 	Ceiling Mount Bracket <b>WV-QCL100-W</b> <sup>*1</sup> (i-PRO white) 
		Adapter Box <b>WV-QJB500-W</b> (i-PRO white)  *If needed.	Wall Mount Brackets <b>WV-QWD100G-W</b> (Smoke) <b>WV-QWD100C-W</b> (Clear) (i-PRO white) 	Wall Mount Brackets <b>WV-QWD100G-W</b> (Smoke) <b>WV-QWD100C-W</b> (Clear) (i-PRO white) 	

\*1 : It's possible to be used on the camera side and ceiling side. If used on both side, 2pieces are required.

	CEILING		
	1	2	3
combination	Ceiling Mount Brackets <b>WV-QED100G-W</b> (Smoke) <b>WV-QED100C-W</b> (Clear) (i-PRO white) 	Ceiling Mount Brackets <b>WV-QCD100G-W</b> (Smoke) <b>WV-QCD100C-W</b> (Clear) (i-PRO white) 	Ceiling Mount Bracket <b>WV-Q105A</b> (Silver) 

### Inner Cover

Inner Cover  
**WV-QAT100**



### Trademarks and registered trademarks

- GlobalSign and the GlobalSign Logo are registered trademarks of GMO GlobalSign K.K.
- iPad and iPhone are trademarks of Apple Inc., registered in the U.S. and other countries.
- Android is a trademark of Google LLC.
- ONVIF is a trademark of ONVIF, Inc.
- All other trademarks identified herein are the property of their respective owners.

### Important

- Safety Precautions : Carefully read the Basic Information, Installation Guide and Operating Instructions before using this product.
- i-PRO Co., Ltd. cannot be held responsible for the performance of the network and/or other manufacturers' products used on the network.
- Masses and dimensions are approximate. • Specifications are subject to change without notice.