

## Industry thinnest multi-sensor cameras with AI Engine

\*the thinnest : i-PRO own research as of February 2022

**WV-S8574L (G) WV-S8544L(G)**  
**WV-S8573L (G) WV-S8543L (G)**  
**WV-S8564L(G) WV-S8544 (G)**  
**WV-S8563L (G) WV-S8543 (G)**  
**(-G:Smoke Dome type)**

## Ace class thinness\*

\*i-PRO own research as of February 2022

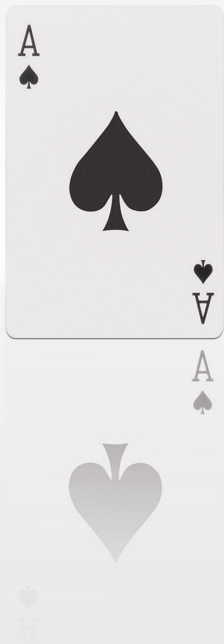

\*The direction of i-PRO logo is different from the actual one.

i-PRO releases 8 the industry thinnest multi-sensor cameras with AI Engine with lineup of 4MP/6MP/4K, 3eyes/4eyes with built-in IR LED\*. It is installed AI analytics applications which identify people and vehicles automatically, and users are able to start the latest surveillance technologies easily. It is designed to reduce installation time(thin and light weight) and continuous view assistance provides you 360/270-degree continuous images.

\*WV-S8544(G) and WV-S8543(G) are not built-in IR LED models.



### Key features

1. The thinnest multisensor camera (3.5 inches/90mm)
2. A variety kinds of AI Apps selection
3. Easy installation
4. High security

### Industry examples

- Public safety (City / Highway toll / Parking gate)
- Transportation (Airport / Train / Subway)
- Retail
- Education

## Specifications

		4K model	6MP model
		<b>WV-S8574L(G)</b> <b>WV-S8573L(G)</b>	<b>WV-S8564L(G)</b> <b>WV-S8563L(G)</b>
			
<b>Camera</b>	Image Sensor	1/2.8 type CMOS image sensor WV-S8574L(G) : 4x4K (33MP), WV-S8573L(G) : 3x4K (25MP)	1/2.8 type CMOS image sensor WV-S8564L(G) : 4x6MP (25MP), WV-S8563L(G) : 3x6MP (19MP)
	Minimum Illumination	Color : 0.084 lx (-G: 0.24 lx) [30IRE, F1.44, 1/30 s] <sup>1</sup> , 0.12 lx (-G: 0.34 lx) [50IRE, F1.44, 1/30 s] BW : 0.05 lx (-G: 0.14 lx) [50IRE, F1.44, 1/30 s], 0 lx [50IRE, F1.44, 1/30 s with IR LED]	
	Maximum shutter	15 fps mode: Max.1/10000s to Max.16/30s, 12.5 fps mode: Max.1/10000s to Max.16/25s	
	Intelligent Auto	On / Off	
	Super Dynamic	On / Off, The level can be set in the range of 0 to 31.	
	Dynamic Range	Max.120 dB (Super Dynamic : On, Level 31)	
	Color/BW (ICR)	Off / On (IR Light Off) / On (IR Light On) / Auto1 (IR Light Off) / Auto2 (IR Light On) / Auto3 (SCC)	
	IR LED Light	High / Middle / Low / Off Maximum irradiation distance : 40 m (Approx. 131 ft) / (-G): 30 m (Approx. 99 ft) (30IRE) <sup>1</sup> , 30 m (Approx. 99 ft) / (-G): 21 m (Approx. 69 ft) (50IRE)	
	Digital Noise Reduction	The level can be set in the range of 0 to 255.	
	Panorama	WV-S8574L(G), WV-S8564L(G) : Panorama mode (H: 180 deg.) WV-S8573L(G), WV-S8563L(G) : Panorama mode (H: 170 deg.)	
	AI Analytics	Yes	
	Privacy Zone	On / Off, Up to 8 zones available	
Image rotation <sup>2</sup>	0° (Off) / 90° / 180° (Upside-down) / 270°		
Focus Adjustment	—		
<b>Lens</b>	Optical zoom	1x	
	Focal length	3.1 mm (1/8 inches)	
	Angular Field of View	Horizontal : 108°, Vertical : 56°	
	Maximum Aperture Ratio	1 : 1.4	
<b>DORI</b>	Focus range	3 m (9.84 ft) – ∞	
	Detect (25ppm / 8ppf)	56.8 m / 186.4 ft	
	Observe (62.5ppm / 19ppf)	22.7 m / 74.6 ft	
	Recognize (125ppm / 38ppf)	11.4 m / 37.3 ft	
Identify (250ppm / 76ppf)	5.7 m / 18.6 ft		
<b>System on Chips (SoC)</b>		Ambarella CV2	
<b>Adjusting Angle</b>		Horizontal : ±125° (Adjust by horizontal (PAN) angle) Vertical : +10° to +105° (Adjust by vertical (TILT) angle) Yaw : ±90° (Adjust by azimuth (YAW) angle) Twist : ±30° *The above is the adjustable range of a single camera. The adjustable range of each camera varies according to the positional relationship with other cameras.	
<b>Browser GUI</b>	GUI / Setup Menu Language	English, Italian, French, German, Spanish, Portuguese, Russian, Chinese, Japanese	
	Browser <sup>3</sup>	Microsoft Edge, Firefox, Google Chrome	
<b>Network</b>	Network IF	10Base-T / 100Base-TX / 1000Base-T, RJ45 connector	
	Resolution	[16:9 mode] H.265 / H.264 / JPEG (MJPEG) 3840x2160, 2560x1440, 1920x1080, 1280x720, 640x360, 320x180	[16 : 9 mode] 3328x1872 / 2560x1440 / 1920x1080 / 1280x720 / 640x360 / 320x180
	H.265 / Transmission Mode	Constant bit rate / VBR / Frame rate / Best effort	
	H.264 <sup>4</sup> / Transmission Type	Unicast port (AUTO) / Unicast port (MANUAL) / Multicast	
	JPEG / Image Quality	10 steps	
	Smart Coding	<b>GOP (Group of pictures) control</b> : On (Frame rate control)* / On (Advanced)* / On (Mid) / On (Low) / Off *On (Frame rate control) and On (Advanced) are only available with H.265. <b>Smart VIQS</b> : On (High) / On (Low) / Off, <b>Smart P-picture control</b> : On / Off	
	Audio Compression	G.726 (ADPCM) : 16 kbps / 32 kbps G.711 : 64 kbps AAC-LC <sup>5</sup> : 64 kbps / 96 kbps / 128 kbps	
	Audio transmission mode	Off / Mic (Line) input / Audio output / Interactive (Half duplex) / Interactive (Full duplex)	
	Supported Protocol	IPv6 : TCP/IP, UDP/IP, HTTP, HTTPS, SSL/TLS, SMTP, DNS, NTP, SNMPv1/v2/v3, DHCPv6, RTP, MLD, ICMP, ARP, IEEE 802.1X, DiffServ, LLDP, MQTT IPv4 : TCP/IP, UDP/IP, HTTP, HTTPS, SSL/TLS, SMTP, RTP, RTCP, ICMP, DNS, DDNS, NTP, SNMPv1/v2/v3, UPnP, IGMP, ICMP, ARP, IEEE 802.1X, DiffServ, SRTP, LLDP, MQTT	
	No. of Simultaneous Users	Up to 24 users (Depends on network conditions)	
	Secure	FIPS 140-2 level3	
	SDXC/SDHC/SD Memory Card	H.265 / H.264 recording : Manual REC / Alarm REC (Pre/Post) / Schedule REC / Backup upon network failure JPEG recording : Manual REC / Alarm REC (Pre/Post) / Backup upon network failure Compatible Memory Card : micro SDXC/SDHC/SD memory card	
Mobile Terminal Compatibility	iPad, iPhone, Android™ terminals		
ONVIF <sup>6</sup> Profile	G / M / S / T		
<b>Alarm</b>	Alarm Source	3 terminals input, VMD alarm, SCD alarm, Command alarm, Audio detection alarm	
	Alarm Actions	SDXC/SDHC/SD memory recording, E-mail notification, HTTP alarm notification Indication on browser, TCP alarm notification output	
<b>Input/ Output</b>	Monitor Output (for adjustment)	—	
	Audio input <sup>6</sup>	ø3.5 mm stereo mini jack Recommended applicable microphone : Plug-in power type (Sensitivity of microphone : -48 dB±3 dB (0 dB=1 V/Pa, 1 kHz)) Input impedance : Approx. 2 kΩ (unbalanced) Supply voltage : 2.4 V ±0.5 V	
	For microphone input :	Input level : Approx. -10 dBV	
	For line input :	Input level : Approx. -10 dBV	
Audio Output <sup>6</sup>	ø3.5 mm stereo mini jack (monaural output), Output impedance : Approx. 600 Ω (unbalanced), Output level : -20 dBV		
External I/O Terminals <sup>6</sup>	ALARM IN 1 (Alarm input 1/ Black & white input/ Auto time adjustment input) (x1), ALARM IN 2 (Alarm input 2/ ALARM OUT) (x1), ALARM IN 3 (Alarm input 3/ ALARM OUT/ AUX OUT) (x1)		
<b>General</b>	Safety	UL (UL62368-1), c-UL (CSA C22.2 No.62368-1), CE, IEC62368-1	
	EMC	FCC (Part15 ClassA), ICES-003 ClassA, EN55032 ClassA, EN55024	
	Power Source and Power Consumption	PoE+ (IEEE802.3at compliant) : DC 54 V : 470 mA/Approx. 25.4 W (Class 4 device)	
	Ambient Operating Temperature	-40 °C to +60 °C <sup>7</sup> [-40 °F to 140 °F] (Power on range: -20 °C to +60 °C [-4 °F to 140 °F]) Maximum temperature according to NEMA TS 2 (2.2.7) : 74 °C (165 °F)	
	Ambient Operating Humidity	10 to 100 % (no condensation)	
	Anti-Condensation System	Temish element + moisture absorption gel	
	Water and Dust Resistance	IP67/IP66 (IEC 60529), Type 4X (UL50E), NEMA 4X compliant	
	Shock Resistance	IK10 (IEC 62262)	
	Other standard support	NEMA TS 2 (2.2.7-2.2.9)	
	Dimensions	When using the attachment plate only : ø300 mm × 90 mm (H) [ø11-13/16 inches × 3-17/32 inches (H)]	
	Mass (approx.)	When using the attachment plate only : Approx. S8574L(G):3.3kg (7.28lbs)/S8573L(G):3.1kg (6.83lbs)   When using the attachment plate only : Approx. S8564L(G):3.3kg (7.28lbs)/S8563L(G):3.1kg (6.83lbs)	
	Finish	Main body : Aluminum die cast, I-PRO white Outer fixing screws : Stainless steel (Corrosion-resistant treatment) Dome cover : PC resin, Clear / PC resin, Smoke (G)	

\*1 Converted value

\*2 When the 320x180 resolution is used, the "90°" and "270°" settings are not available.

\*3 For information on the operation verification of the supported web browsers, refer to our support website &lt;Control No.: C0132&gt;.



\*4 Transmission for each stream can be individually set.

\*5 When recording audio on an microSD memory card, only use AAC-LC (Advanced Audio Coding - Low Complexity).

\*6 When using with these, WV-QCA501A cable is required.

\*7 When using with the IR LED light constantly lit, the upper limit of the operating temperature range is +50 °C [+122 °F].

## Specifications

		4MP IR-LED model	4MP Non IR-LED model
		<b>WV-S8544L(G)</b> <b>WV-S8543L(G)</b>	<b>WV-S8544(G)</b> <b>WV-S8543(G)</b>
			
<b>Camera</b>	Image Sensor	1/2.7 type CMOS image sensor WV-S8544L(G)/WV-S8544(G) : 4x4MP (16MP), WV-S8543L(G)/WV-S8543(G) : 3x4MP (12MP)	
	Minimum Illumination	Color : 0.21 lx (-G: 0.59 lx) {30IRE, F1.44, 1/30 s} <sup>1</sup> , 0.3 lx (-G: 0.85 lx) {50IRE, F1.44, 1/30 s} BW : 0.12 lx (-G: 0.34 lx) {50IRE, F1.44, 1/30 s}, 0 lx {50IRE, F2.0, 1/30 s with IR LED}	
	Maximum shutter	30 fps mode: Max.1/10000s to Max.16/30s, 25 fps mode: Max.1/10000s to Max.16/25s	
	Intelligent Auto	On / Off	
	Super Dynamic	On / Off, The level can be set in the range of 0 to 31.	
	Dynamic Range	Max. 108 dB(Super Dynamic: On, Level: 31)	
	Color/BW (ICR)	Off / On(IR Light Off) / On(IR Light On) / Auto1(IR Light Off) / Auto2(IR Light On) / Auto3(SCC)	
	IR LED Light	High / Middle / Low / Off Maximum irradiation distance : 20 m (Approx. 66 ft) / (-G): 15 m (Approx. 49 ft) {30IRE} <sup>1</sup> : 15 m (Approx. 49 ft) / (-G): 11 m (Approx. 36 ft) {50IRE}	
	Digital Noise Reduction	The level can be set in the range of 0 to 255.	
	Panorama	WV-S8544L(G), WV-S8544(G): Panorama mode (H: 180 deg.) WV-S8543L(G), WV-S8543(G): Panorama mode (H: 170 deg.)	
	AI Analytics	Yes	
	Privacy Zone	On / Off, Up to 8 zones available	
	Image rotation*2	0° (Off) / 90° / 180° (Upside-down) / 270°	
	Focus Adjustment	Auto focus	
	<b>Lens</b>	Optical zoom	2.5x (Motorized zoom / Motorized focus)
Focal length		2.9 - 7.3 mm {1/8 - 1/4 inches}	
Angular Field of View		Horizontal: 43°(TELE) - 100°(WIDE), Vertical: 24°(TELE) - 56°(WIDE)	
Maximum Aperture Ratio		1 : 2.0(WIDE) - 1 : 3.0(TELE)	
Focus range		1 m {3.28 ft} - ∞	
<b>DORI</b>	Detect (25ppm / 8ppf)	Wide : 45.1 m / 148.0 ft, Tele : 147.7 m / 484.6 ft	
	Observe (62.5ppm / 19ppf)	Wide : 18.0 m / 59.2 ft, Tele : 59.1 m / 193.8 ft	
	Recognize (125ppm / 38ppf)	Wide : 9.0 m / 29.6 ft, Tele : 29.5 m / 96.9 ft	
	Identify (250ppm / 76ppf)	Wide : 4.5 m / 14.8 ft, Tele : 14.8 m / 48.5 ft	
<b>System on Chips (SoC)</b>		Ambarella CV2	
<b>Adjusting Angle</b>		Horizontal : ±125° (Adjust by horizontal (PAN) angle) Vertical : +10° to +105° (Adjust by vertical (TILT) angle) Yaw : ±90° (Adjust by azimuth (YAW) angle) Twist : ±30° *The above is the adjustable range of a single camera. The adjustable range of each camera varies according to the positional relationship with other cameras.	
<b>Browser GUI Network</b>	GUI / Setup Menu Language	English, Italian, French, German, Spanish, Portuguese, Russian, Chinese, Japanese	
	Browser <sup>3</sup>	Microsoft Edge, Firefox, Google Chrome	
	Network IF	10Base-T / 100Base-TX / 1000Base-T, RJ45 connector	
	Resolution	<b>[16 : 9 mode]</b> 2688 x 1520 / 2560 x 1440 / 1920x1080 / 1280 x 720 / 640x360 / 320x180	
	H.265 / H.264 / JPEG (MJPEG)	Constant bit rate / VBR / Frame rate / Best effort	
	H.265 / Transmission Mode	Unicast port (AUTO) / Unicast port (MANUAL) / Multicast	
	H.264 <sup>4</sup> / Transmission Type	10 steps	
	JPEG / Image Quality	<b>GOP (Group of pictures) control</b> : On (Frame rate control)* / On (Advanced)* / On (Mid) / On (Low) / Off *On (Frame rate control) and On (Advanced) are only available with H.265. <b>Smart VIQs</b> : On(High)/On(Low)/Off, <b>Smart P-picture control</b> : On/Off	
	Smart Coding	G.726 (ADPCM) : 16 kbps / 32 kbps G.711 : 64 kbps AAC-LC <sup>5</sup> : 64 kbps / 96 kbps / 128 kbps	
	Audio Compression	Off / Mic (Line) input / Audio output / Interactive (Half duplex) / Interactive (Full duplex)	
	Audio transmission mode	Supported Protocol IPv6 : TCP/IP, UDP/IP, HTTP, HTTPS, SSL/TLS, SMTP, DNS, NTP, SNMPv1/v2/v3, DHCPv6, RTP, MLD, ICMP, ARP, IEEE 802.1X, DiffServ, LLDP, MQTT IPv4 : TCP/IP, UDP/IP, HTTP, HTTPS, SSL/TLS, RTSP, RTP, RTP/RTCP, SMTP, DHCP, DNS, DDNS, NTP, SNMPv1/v2/v3, UPnP, IGMP, ICMP, ARP, IEEE 802.1X, DiffServ, SRTP, LLDP, MQTT	
	No. of Simultaneous Users	Up to 24 users (Depends on network conditions)	
	Secure	FIPS 140-2 level3	
	SDXC/SDHC/SD Memory Card	H.265 / H.264 recording : Manual REC / Alarm REC (Pre/Post) / Schedule REC / Backup upon network failure JPEG recording : Manual REC / Alarm REC (Pre/Post) / Backup upon network failure Compatible Memory Card : micro SDXC/SDHC/SD memory card	
	Mobile Terminal Compatibility	iPad, iPhone, Android™ terminals	
ONVIF® Profile	G / M / S / T		
<b>Alarm</b>	Alarm Source	3 terminals input, VMD alarm, SCD alarm, Command alarm, Audio detection alarm	
	Alarm Actions	SDXC/SDHC/SD memory recording, E-mail notification, HTTP alarm notification Indication on browser, TCP alarm notification output	
<b>Input/Output</b>	Monitor Output (for adjustment)	—	
	Audio input <sup>6</sup>	ø3.5 mm stereo mini jack For microphone input : Recommended applicable microphone : Plug-in power type (Sensitivity of microphone : -48 dB±3 dB (0 dB=1 V/Pa, 1 kHz)) Input impedance : Approx. 2 kΩ (unbalanced) Supply voltage : 2.4 V ±0.5 V Input level : Approx. -10 dBV	
	Audio Output <sup>6</sup>	ø3.5 mm stereo mini jack (monaural output), Output impedance : Approx. 600 Ω (unbalanced), Output level : -20 dBV	
	External I/O Terminals <sup>6</sup>	ALARM IN 1 (Alarm input 1/ Black & white input/ Auto time adjustment input) (x1), ALARM IN 2 (Alarm input 2/ ALARM OUT) (x1), ALARM IN 3 (Alarm input 3/ ALARM OUT/ AUX OUT) (x1)	
<b>General</b>	Safety	UL (UL62368-1), c-UL (CSA C22.2 No.62368-1), CE, IEC62368-1	
	EMC	FCC (Part15 ClassA), ICES-003 ClassA, EN55032 ClassA, EN55024	
	Power Source and Power Consumption	PoE+ (IEEE802.3at compliant): DC 54 V: 470 mA/Approx. 25.4 W (Class 4 device) DC 54 V: 320 mA/Approx. 17.3 W (Class 4 device)	
	Ambient Operating Temperature	-40 °C to +60 °C <sup>7</sup> [-40 °F to 140 °F] (Power on range: -20 °C to +60 °C [-4 °F to 140 °F]) Maximum temperature according to NEMA TS 2 (2.2.7): 74 °C (165 °F)	
	Ambient Operating Humidity	10 to 100 % (no condensation)	
	Anti-Condensation System	Temish element + Heater + moisture absorption gel	
	Water and Dust Resistance	IP67/IP66 (IEC 60529), Type 4X (UL50E), NEMA 4X compliant	
	Shock Resistance	IK10 (IEC62262)	
	Other standard support	NEMA TS 2 (2.2.7-2.2.9)	
	Dimensions	When using the attachment plate only : ø300 mm × 90 mm (H) {ø11-13/16 inches × 3-17/32 inches (H)}	
	Mass (approx.)	When using the attachment plate only : Approx. S8544L(G):3.3kg {7.28lbs}/S8543L(G):3.1kg {6.83lbs}   When using the attachment plate only : Approx. S8544(G):3.3kg {7.28lbs}/S8543(G):3.1kg {6.83lbs}	
Finish	Main body : Aluminum die cast, i-PRO white Outer fixing screws : Stainless steel (Corrosion-resistant treatment) Dome cover : PC resin, Clear / PC resin, Smoke (G)		

\*1 Converted value

\*2 When the 320x180 resolution is used, the "90°" and "270°" settings are not available.

\*3 For information on the operation verification of the supported web browsers, refer to our support website &lt;Control No.: C0132&gt;.

\*4 Transmission for each stream can be individually set.

\*5 When recording audio on a microSD memory card, only use AAC-LC (Advanced Audio Coding - Low Complexity).

\*6 When using with these, WV-QCA501A cable is required.

\*7 When using with the IR LED light constantly lit, the upper limit of the operating temperature range is +50 °C {+122 °F}.

## AI Analytics applications

<https://i-pro.com/global/en/surveillance/products/i-pro-ai-application>

### AI Video Motion Detection (AI-VMD)

Advanced video analysis technology detects objects (faces, people, cars, motorcycles) in a specified area. (Intruder Detection, Loitering Detection, Direction Detection, Cross Line Detection)

### AI Face Detection

Detects faces with high precision even in low-light, backlit, and mask-wearing environments. (Max. 2 cameras working)

### AI People Detection

Extract the characteristics of human face / clothing and classify them into meaningful categories such as gender, age, and clothing color.

### AI Vehicle Detection

Extract vehicle characteristics and classify them into meaningful categories such as type and color.

### AI Non mask Detection

Deep-learning and proprietary image processing technologies recognize mask and detect people who are not wearing them.

### AI Occupancy Detection

Detecting the congestion via network camera with AI engine enables that information to be used direct visitors in advance or help store staff work more efficiently.

## Appearance

Unit : mm (inches)

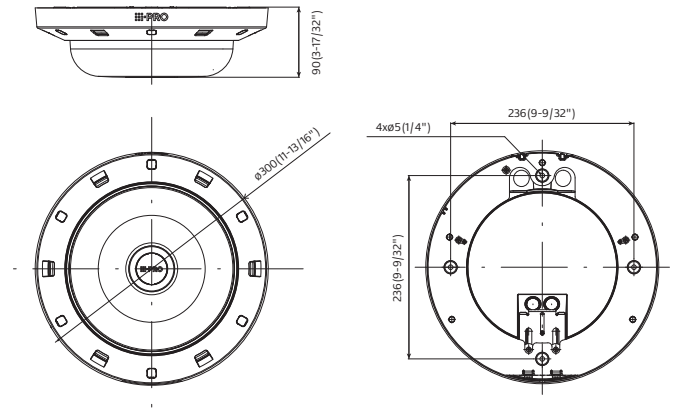

















3rd party applications are also available.



<https://i-pro.com/global/en/surveillance/i-pro-application-platform/application-list>

## Optional Accessories

### Mount Bracket / Other

	WALL	POLE	CORNER	HANGING			CEILING	
	1	1	1	1	2	3	1	2
combination	Wall Mount Bracket <b>WV-QWL501-W</b> (i-PRO white) 	Pole Mount Bracket <b>WV-QPL500-W</b> (i-PRO white) 	Corner Mount Bracket <b>WV-QCN500-W</b> (i-PRO white) 	Ceiling Mount Bracket <b>WV-QCL501-W</b> (i-PRO white) 	Ceiling Mount Bracket <b>WV-QCL100-W</b> (i-PRO white)  *For indoor installation only.	Ceiling Mount Bracket <b>WV-QCL100-W</b> <sup>*1</sup> (i-PRO white)  *For indoor installation only.	Base Bracket <b>WV-QJB503-W</b> (i-PRO white)  *The actual product may differ.	Ceiling Mount Bracket <b>WV-Q105A</b> (Silver)  *For indoor installation only.
	Mount Bracket <b>WV-QSR503-W</b> (i-PRO white) 	Wall Mount Bracket <b>WV-QWL501-W</b> (i-PRO white) 	Wall Mount Bracket <b>WV-QWL501-W</b> (i-PRO white) 	Mount Bracket <b>WV-QSR503-W</b> (i-PRO white) 	Mount Bracket <b>WV-QSR503M-W</b> (i-PRO white, ISO Male thread) 	3 <sup>rd</sup> Party Pipe (i-PRO white, ISO Male thread)		Base Bracket <b>WV-QJB503-W</b> (i-PRO white)  *The actual product may differ.
		Mount Bracket <b>WV-QSR503-W</b> (i-PRO white) 	Mount Bracket <b>WV-QSR503-W</b> (i-PRO white) 			Mount Bracket <b>WV-QSR503F-W</b> (i-PRO white, ISO Female thread) 		

\*1: It's possible to be used on the camera side and ceiling side. If used on both side, 2pieces are required.

OTHER	
combination	1  3 <sup>rd</sup> Party Pipe (Male or Female thread)
	Mount Bracket <b>WV-QSR503F-W</b> (i-PRO white, ISO Female thread) 
	Mount Bracket <b>WV-QSR503M-W</b> (i-PRO white, ISO Male thread) 

### Trademarks and registered trademarks

- iPad and iPhone are trademarks of Apple Inc., registered in the U.S. and other countries.
- Android is a trademark of Google LLC.
- ONVIF is a trademark of ONVIF, Inc.
- All other trademarks identified herein are the property of their respective owners.

### Important

- Safety Precautions : Carefully read the Basic Information, Installation Guide and Operating Instructions before using this product.
- i-PRO Co., Ltd. cannot be held responsible for the performance of the network and/or other manufacturers' products used on the network.

• Masses and dimensions are approximate. • Specifications are subject to change without notice.