

Edge AI 360-degree fisheye camera that provides video surveillance without any blind spots and business intelligence.

12MP Sensor IR In-vehicle 360 Fisheye Network Camera with AI engine

The new S-series fisheye camera is a new-generation camera equipped with an AI processor that realizes edge AI processing. With a high-performance fisheye lens and our own video compression technology, it is possible to clearly shoot 360 degrees in all directions up to the periphery of the screen with a single camera.

The camera is equipped with an AI processor, and contribute to solve various problems by installing an AI application according to the purpose.

It is possible to visualize the number of people and the congestion status with a dashboard that can be customized according to the customer's operation style, and use it for business intelligence purposes.

Key features

- The AI processor equipped with a camera realizes motion detection of people / vehicles, number counting, and congestion detection. It also supports third-party AI applications and can meet a variety of AI demands. The data aggregated inside the camera can be visualized on the dashboard in cooperation with our system, and can be used for marketing and business intelligence.
- Equipped with industry standard protocols such as ONVIF, it can be linked with third-party display software as an IoT terminal for sensor networks. Furthermore, it is possible to integrate and utilize it in another system customized according to the customer's operation.
- Equipped with a high-performance fisheye lens that has been well-established in the market, one camera can clearly shoot 360 ° in all directions up to the periphery of the screen.
- Our original smart coding compatible with H.264 and H.265 delivers high-resolution video at high image quality and low bit rate. Achieved useful images by combining with highly visible images by the intelligent auto (iA) function.

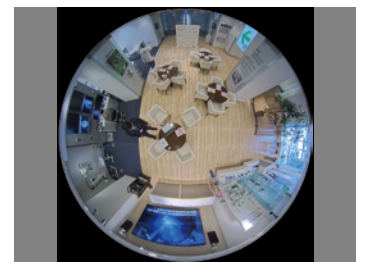

2992 x 2992
4000 x 3000

Key i-PRO Spec.

- 12MP Sensor
- 2992x2992 pixel fisheye images up to 30fps
- Intelligent Auto (with AI Engine)
- Smart Coding (with AI Engine)
- ABF (Auto Back Focus)
- IP66, IK10, 50J compliant, Anti-Condensation System
- Built-in IR LED
- ONVIF® Profile G / M / S / T

*ONVIF is a trademark of ONVIF, Inc.

Industry examples

- Train
- Light rail transit
- Subway car
- Bus
- Railroad Crossing



Specifications

Camera	Image Sensor	Approx. 1/2 type 12MP CMOS image sensor	
	Minimum Illumination	Color : 0.3 lx, BW : 0.04 lx (F1.9, Maximum shutter : Off (1/30 s), AGC : 11) BW : 0 lx (F1.9, Maximum shutter : Off (1/30 s), AGC : 11, when the IR LED is lit) Color : 0.02 lx, BW : 0.003 lx (F1.9, Maximum shutter : max. 16/30s, AGC : 11) *1	
	Intelligent Auto	On / Off	
	Maximum shutter	Max.16/30s to Max. 1/10000s	
	Wide Dynamic Range*2	On / Off. The level can be set in the range of 0 to 31.	
	Dynamic Range	Max.84 dB (Wide Dynamic Range : On, level : 31)	
	Image Settings	Gain (AGC), White balance	
	Image Compensation	Adaptive black stretch, Back light compensation (BLC), Fog compensation, High light compensation (HLC), Digital noise reduction	
	Color/BW (ICR)	Off / On (IR Light Off) / On (IR Light On) / Auto1 (IR Light Off) / Auto2 (IR Light On) / Auto3 (SCC)	
	IR LED Light	High* / Middle / Low / Off *Maximum irradiation distance : 14 m(Approx. 45 ft)(30IRE)*1, 10 m (Approx. 33 ft) (Mounting height : Approx. 3 m, Peripheral intensity control : On)	
	Video Motion Detection (VMD)	On / Off, 4 areas available	
	Scene Change Detection (SCD)	On / Off, 1 areas available	
	Audio Detection	On / Off	
	AI Sound Classification	Gunshot, Yell, Vehicle horn, Glass break	
	AI Analytics	Yes	
	Privacy Zone	On / Off. Up to 8 zones available	
	Camera Title (OSD)	On / Off. Up to 20 characters (alphanumeric characters, marks)	
	Fixing angle adjustment	-5°, 0°, +5°	
	Lens	Zoom Ratio	1x
		Digital (electronic) zoom	Choose from 3 levels of x1, x2, x4
Focal length		1.4 mm (1/16 inches)	
Maximum Aperture Ratio		1 : 1.9	
DORI	Focus range	0.5 m (19-11/16 inches) - ∞	
	Angular Field of view	Horizontal : 183° Vertical : 183°	
	Distance to the object in the center of the image	Detect (25 ppm / 8 ppf) : 29.9 m / 98.2 ft Observe (62.5 ppm / 19 ppf) : 12.0 m / 39.3 ft Recognize (125 ppm / 38 ppf) : 6.0 m / 19.6 ft Identify (250 ppm / 76 ppf) : 3.0 m / 9.8 ft	
	Coverage radius when mounted at a height of 3 m (10 ft)	Detect (25 ppm / 8 ppf) : 56.1 m / 184.2 ft Observe (62.5 ppm / 19 ppf) : 20.6 m / 67.6 ft Recognize (125 ppm / 38 ppf) : 8.4 m / 27.6 ft Identify (250 ppm / 76 ppf) : 0.3 m / 0.9 ft	
Browser GUI	Camera Control	Brightness, AUX On / Off	
	Audio	Mic (Line) input : On / Off Volume adjustment : Low / Middle / High Audio Output : On / Off Volume adjustment : Low / Middle / High	
	GUI / Setup Menu Language	English, Italian, French, German, Spanish, Portuguese, Russian, Chinese, Japanese	
Network	Network IF	10Base-T / 100Base-TX, M12 connector	
	Resolution	<Ceiling> <Wall> *Fisheye mode (max. 30 fps/25 fps) 2992×2992 / 2192×2192 / 1280×1280 / 640×640 / 320×320 *Quad PTZ mode (max. 15 fps/12.5 fps), Single PTZ mode (max. 15 fps/12.5 fps) 2560×1920*3 / 2048×1536 / 1600×1200 / 1280×960 / 800×600 / VGA / QVGA	
		<Ceiling> *Double Panorama mode (max. 15 fps/12.5 fps) 2560×1440 / 1920×1080 / 1280×720 / 640×360 / 320×180 *Fisheye + Double Panorama mode (max. 15 fps/12.5 fps) (Fisheye) 2992×2992 / 2192×2192 / 1280×1280 / 640×640 / 320×320 (Double Panorama) 1280×720 / 640×360 / 320×180 *Fisheye + Quad PTZ mode (max. 15 fps/12.5 fps) (Fisheye) 2992×2992 / 2192×2192 / 1280×1280 / 640×640 / 320×320 (Quad PTZ) 1280×960 / 800×600 / VGA / QVGA *Quad streams mode (Single PTZ (Quad streams)) 1280×960 / 800×600 / VGA / QVGA (max. 15 fps/12.5 fps) (Quad PTZ) 2560×1920 / 2048×1536 / 1600×1200 / 1280×960 / 800×600 / VGA / QVGA (max. 5 fps)	
		<Wall> *Panorama mode (max. 15 fps/12.5 fps) 2560×1440 / 1920×1080 / 1280×720 / 640×360 / 320×180 *Fisheye + Panorama mode (max. 15 fps/12.5 fps) (Fisheye) 2992×2992 / 2192×2192 / 1280×1280 / 640×640 / 320×320 (Panorama) 1280×720 / 640×360 / 320×180	

Network	H.265/ H.264*4	Transmission Mode	Constant bit rate / VBR / Frame rate / Best effort
	JPEG	Transmission Type	Unicast port (AUTO) / Unicast port (MANUAL) / Multicast
	Smart Coding	Image Quality	10 steps
	Audio Compression	GOP (Group of pictures) control :	On (Frame rate control) * / On (Advanced)* / On (Mid) / On (Low) / Off * *On (Frame rate control) and On (Advanced) are only available with H.265. Auto VQIS : On / Off
	Supported Protocol	G.726 (ADPCM) : 16 kbps / 32 kbps, G.711 : 64 kbps, AAC-LC*5 : 64 kbps / 96 kbps / 128 kbps	IPV6 : TCP/IP, UDP/IP, HTTP, HTTPS, SSL/TLS, SMTP, DNS, NTP, SNMP v1/v2/v3, DHCPv6, RTP, MLD, ICMP, ARP, IEEE 802.1X, DiffServ IPV4 : TCP/IP, UDP/IP, HTTP, HTTPS, SSL/TLS, RTSP, RTP, RTP/RTCP, SMTP, DHCP, DNS, DDNS, NTP, SNMP v1/v2/v3, UPnP, IGMP, ICMP, ARP, IEEE 802.1X, DiffServ, SRTP
	Maximum concurrent access number	Up to 14 users (Depends on network conditions)	
	SDXC/SDHC/SD Memory Card	H.265 / H.264 recording : Manual REC / Alarm REC (Pre/Post) / Schedule REC JPEG recording : Manual REC / Alarm REC (Pre/Post) Compatible SDXC/SDHC/SD card : 2 GB, 4 GB*, 8 GB*, 16 GB*, 32 GB*, 64 GB**, 128 GB**, 256 GB**.* *SDHC card. **SDXC card (except miniSD card and microSD card)	
	Mobile Terminal Compatibility	iPad, iPhone, Android™ terminals	
	ONVIF® Profile	G / M / S / T	
	Alarm	Alarm Source	3 terminals input, VMD, Command alarm
Alarm Actions		SDXC/SDHC/SD memory recording, E-mail notification, HTTP alarm notification, Indication on browser, TCP alarm notification output	
Input/ Output	Monitor output (for adjustment)	VB5 : 1.0 V [p-p] / 75 Ω, composite, ø3.5 mm mini jack An NTSC or PAL signal can be outputted from camera	
	Audio Input For microphone	ø3.5 mm stereo mini jack, Recommended applicable microphone : Plug-in power type (Sensitivity of microphone : -48 dB ±3 dB (0 dB=1 V / Pa, 1 kHz)) Input impedance : Approx. 2 kΩ (unbalanced) Supply voltage : 2.5 V ±0.5 V For line Input level : Approx. -10 dBV	
	Audio Output*6	ø3.5 mm stereo mini jack (monaural output) Output impedance : Approx. 600 Ω (unbalanced) Output level : -20 dBV	
	External I/O Terminals	ALARM IN1 (Alarm input 1) Black & white input/ Auto time adjustment input (x1) ALARM IN2 (Alarm input 2) ALARM OUT (x1), ALARM IN3 (Alarm input 3) AUX OUT (x1)	
General	Safety	UL (UL62368-1), c-UL (CSA C22.2 No. 62368-1), CE, IEC62368-1	
	EMC	FCC (Part15 ClassA), ICES003 ClassA, EN55032 ClassB, EN55024, EN55035 ECE-R10, EN50498 compliant, EN50121	
	Power Source and Power Consumption	DC power supply : DC 12 V 1.1 A/Approx. 13.2 W PoE (IEEE802.3af compliant, Alternative A) Device : DC 48 V 270 mA/Approx. 12.95 W (Class 0 device)	
	Ambient Operating Temperature	IR LED : On -40 °C to +50 °C (-40 °F to 122 °F) IR LED : Off -40 °C to +60 °C (-40 °F to 140 °F)	
	Ambient Operating Humidity	10% to 100 % (no condensation)	
	Anti-Condensation System	Rosahl element	
	Water and Dust Resistance	IP66 (IEC60529), Type 4X (UL50), NEMA 4X compliant	
	Shock Resistance	50J (IEC 60068-2-75 compliant), IK10 (IEC 62262)	
	Wind Resistance	Up to 40 m/s (approx. 89 mph)	
	Railway Application	EN45545 compliant, EN50155-TX	
Dimensions	When using the attachment plate only : ø154 mm × 60.3 mm (H) [ø6-1/16 inches × 2-3/8 inches (H)] Dome radius 35 mm [1-3/8 inches]		
Mass (approx.)	When using the attachment plate only : Approx. 880 g (1.94 lbs)		
Finish	Main body : Aluminum die cast, i-PRO white Outer fixing screws : Stainless steel (Corrosion-resistant treatment) Dome section : Polycarbonate resin, Clear		

*1 Converted value
*2 When "On (level 30 or 31)" is selected for "Wide Dynamic Range(WDR)", the frame rate is restricted to a maximum of 15fps (30fps mode) or 12.5fps (25fps mode).
*3 When "Single PTZ" mode is used in wall installations, the 2560×1920 resolution cannot be used.
*4 Transmission for 2 streams can be individually set.
*5 When recording audio on an SD memory card, only use AAC-LC (Advanced Audio Coding - Low Complexity).
*6 The audio output can be switched to the monitor output.
Refer to the Operating Instructions on our support web site for descriptions of how to switch the output.

Appearance

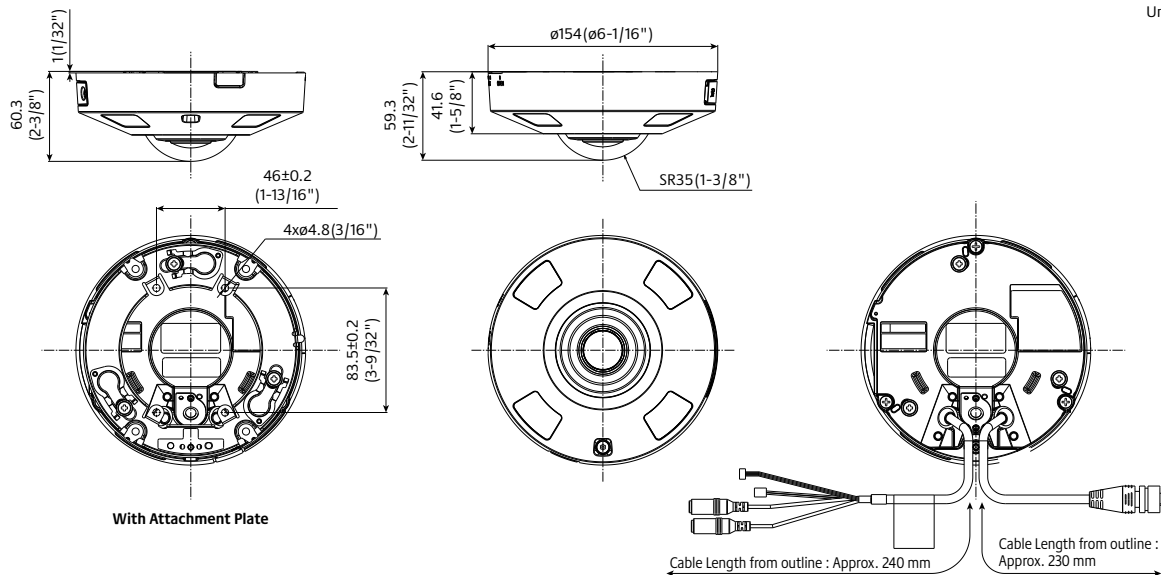

Bundled License

AI-VMD/AI People Counting with the 360-degree fisheye camera

AI Video Motion Detection

- AI differentiates between vehicles and people, detecting and sending warning notifications when an intruder enters a specified area.
- Intruder detection:** Issues an alarm when a moving object enters a specified area.
- Cross Line detection:** Issues an alarm when an object moving in the specified direction crosses a specified threshold.
- Loitering detection:** Issues an alarm when a moving object enters a specified area and stays there for a specified amount of time.



People Counting

- Cross Line Counting:** Counts the number of people moving in a specified direction and cross a specified threshold.
- Area Counting (Queue Management):** Counts the number of people in the set area.

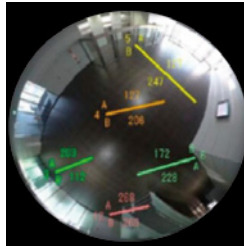

Cross Line Counting

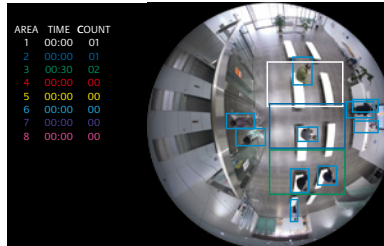

Area Counting

Heat map

- Heat mapping provides statistical information about traffic flow and keeps counts for people passing through and loitering in the area.

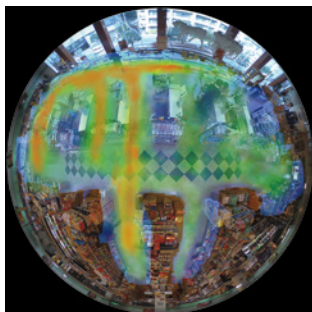

Passing



Loitering

Occupancy detection

- The network camera uses its AI engine to detect congestion, providing data that can be used to direct visitor traffic flow in advance or help staff work more efficiently.

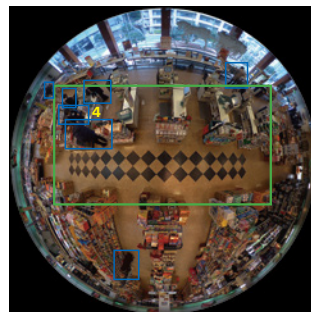

AI Privacy Guard for 360-degree fisheye

AI Privacy Guard

- AI can automatically mosaic faces and figures of people who are photographed to safeguard privacy and portrait rights.



Original image



Processed image

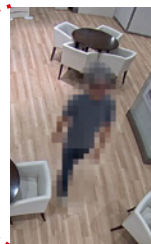

i-PRO Active Guard

- The i-PRO Active Guard stores the best images and metadata captured by i-PRO network cameras, then collates this data with the watch list registered in the client software and issues an alarm when a match is found. The server does not require expensive hardware because i-PRO network cameras handle the advanced processing. The server can even be installed on the same hardware as the VMS. The system comprises the i-PRO Active Guard, the AI application installed on i-PRO network cameras utilizing AI engines, and i-PRO Active Guard Plug-in software for the VMS client.

Example of basic system connection (without i-PRO Active Guard)

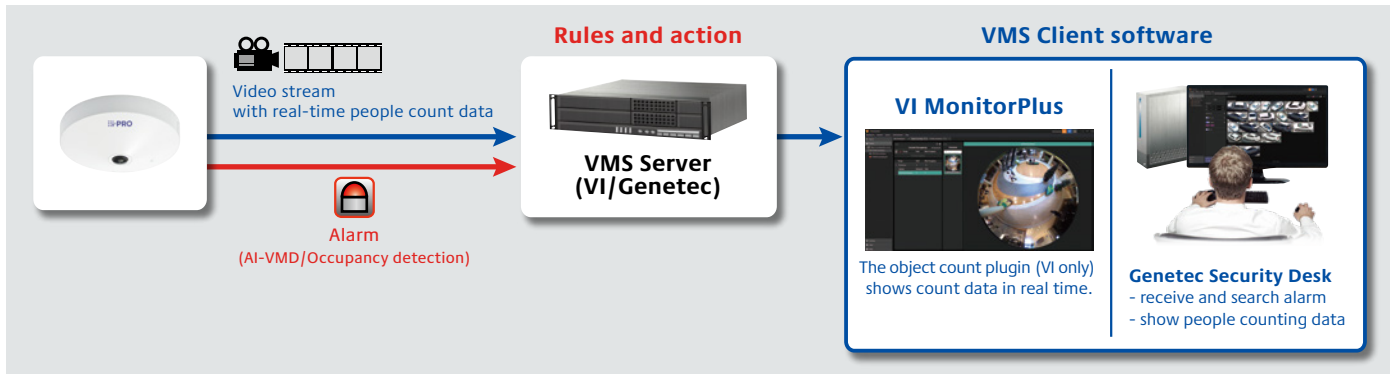

Example of basic system connection (with i-PRO Active Guard) for Video Insight/Genetec

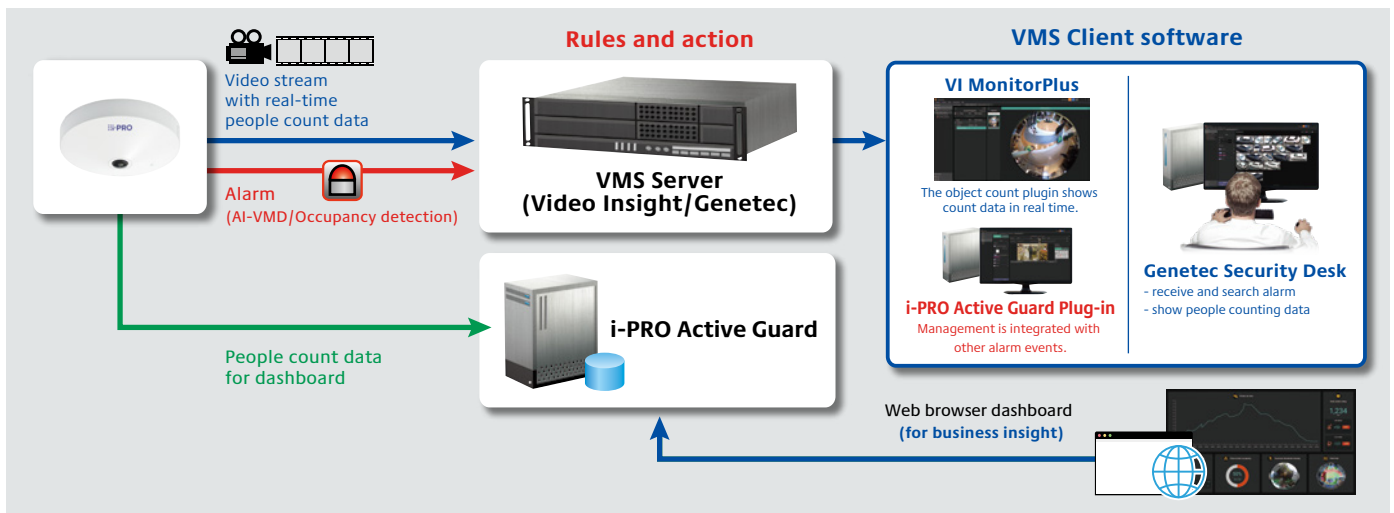

*VMS Server and i-PRO Active Guard can be installed on the same server.

Example of basic system connection for WV-ASM300W/Network disk recorder

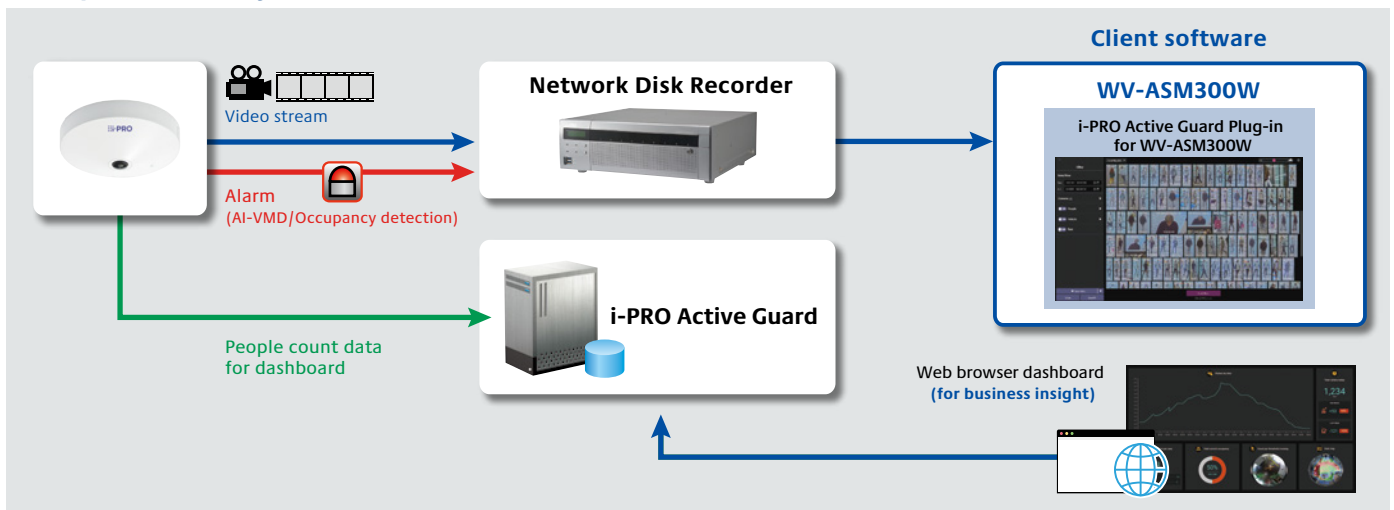

Optional Accessory

Bracket

Base Bracket
WV-QJB501-W
(i-PRO white)



Trademarks and registered trademarks

- iPad and iPhone are trademarks of Apple Inc., registered in the U.S. and other countries.
- Android is a trademark of Google LLC.
- ONVIF is a trademark of ONVIF, Inc.
- All other trademarks identified herein are the property of their respective owners.

Important

- Safety Precautions : Carefully read the Basic Information, Installation Guide and Operating Instructions before using this product.
- i-PRO Co., Ltd. cannot be held responsible for the performance of the network and/or other manufacturers' products used on the network.
- Masses and dimensions are approximate. • Specifications are subject to change without notice.