

**New U-series compact network camera with enhanced functions and affordability**

## 4MP Varifocal Lens Outdoor Dome Network Camera

The new U series is an entry model that achieves high quality and reliability at an affordable price to meet the needs of a wide range of customers. The compact and slim design allows it to be installed in a various locations.

It newly supports ONVIF G / S / T profile and H.265 / H.264, and can be widely used for connecting various VMS and recorders. It also comes pre-installed with secure certificates, enabling device authentication and end-to-end communication encryption to counter the threat of advanced cyberattacks.

### Key features

- Compact and slim design allows installation in various locations
- Compliant with ONVIF G / S / T profile and H.265 / H.264, and can support a wide range of connections to VMS and recorders
- Uses "Easy Kitting Packing" that allows you to set the camera without removing it from the box
- Strengthen cyber security by pre-installing digital certificates issued by a third party organization (GlobalSign)

### Key i-PRO Spec.

- 5MP Sensor
- 2688×1520 pixel image up to 30fps
- 2.5x built-in motorized zoom and motorized focus lens
- iA (intelligent Auto)
- Super Dynamic 102dB
- Color night vision (0.019 to 0.3 lx)
- H.265 Smart Coding
- Corridor mode  
(90 degrees or 270 degrees in image rotation)
- Built-in IR LED
- ONVIF® Profile G / S / T  
\*ONVIF is a trademark of ONVIF, Inc.
- Genetec Stratocast compatible

### Industry examples

- Safe Cities
- Transportation (Airport / Train, Subway station)
- Bank (ATM, Entrance)
- Retail / Logistics / Education / Hospital / Building



# Specifications

<b>Camera</b>	Image Sensor	Approx. 1/2.7 type CMOS image sensor
	Minimum Illumination	Color : 0.3 lx, BW: 0.12 lx (50IRE, F2.0, Maximum shutter: Off (1/30s), AGC: 11) BW : 0 lx (0 footcandle) (50IRE, F2.0, Maximum shutter: OFF (1/30 s), AGC: 11, when the IR LED is lit) Color : 0.019 lx, BW: 0.0075 lx (50IRE, F2.0, Maximum shutter: max. 16/30s, AGC: 11) *1
	White Balance	ATW1/ ATW2/ AWC
	Maximum shutter	<b>[30fps mode]</b> Max. 1/10000 s to Max. 16/30 s <b>[25fps mode]</b> Max. 1/10000 s to Max. 16/25 s
	Intelligent Auto	On / Off
	Super Dynamic	On / Off, The level can be set in the range of 0 to 31.
	Dynamic Range	Max.102 dB (Super Dynamic: On, Level: 31)
	Adaptive Black Stretch	—
	Back light compensation / High light compensation	BLC/ HLC/ Off (only when Super Dynamic/ Intelligent auto: Off)
	Fog compensation	On / Off, The level can be set in the range of 0 to 8. (only when Intelligent auto / auto contrast adjust: Off)
	Maximum gain (AGC)	The level can be set in the range of 0 to 11.
	Color/BW (ICR)	Off/ On (IR Light Off) / On (IR Light On) / Auto1 (IR Light Off) / Auto2 (IR Light On) / Auto3 (SCC)
	IR LED Light	High/ Middle/ Low/ Off Maximum irradiation distance: 20 m (Approx. 65 ft)
	Digital Noise Reduction	The level can be set in the range of 0 to 255.
	<b>Lens</b>	Focal length
Optical zoom		2.5x (Motorized zoom / Motorized focus)
Extra optical zoom		2.5x - 3.3x (when resolution is 1920x1080)
Digital (electronic) zoom		Choose from 3 levels of x1, x2, x4
Angular Field of View		<b>[16 : 9 mode]</b> * [4:3 mode] is not supported. Horizontal : 43° (TELE) - 100° (WIDE), Vertical : 24° (TELE) - 56° (WIDE)
Maximum Aperture Ratio		1 : 2.0 (WIDE) - 1 : 3.0 (TELE)
Focus range		1 m (39-3/8 inches) - ∞
Detect (25ppm / 8ppf)		Wide: 43.0 m / 141.0 ft, Tele: 130.0 m / 426.4 ft
Observe (62.5ppm / 19ppf)		Wide: 17.2 m / 56.4 ft, Tele: 52.0 m / 170.6 ft
Recognize (125ppm / 38ppf)		Wide: 8.6 m / 28.2 ft, Tele: 26.0 m / 85.3 ft
Identify (250ppm / 76ppf)	Wide: 4.3 m / 14.1 ft, Tele: 13.0 m / 42.6 ft	
<b>Adjusting Angle</b>	Ceiling mounting	—
	Wall mounting	—
<b>Browser</b>	Camera Control	Brightness
	GUI / Setup Menu Language	English, Italian, French, German, Spanish, Portuguese, Russian, Chinese, Japanese

\*1 Converted value  
\*2 Smart Coding (GOP and AUTO VIQS) is not available when setting 30fps.  
\*3 It may be necessary to upgrade the firmware to use these protocols.  
\*4 Only when installation work is properly performed according to the Installation Guide and appropriate waterproof treatment is performed.





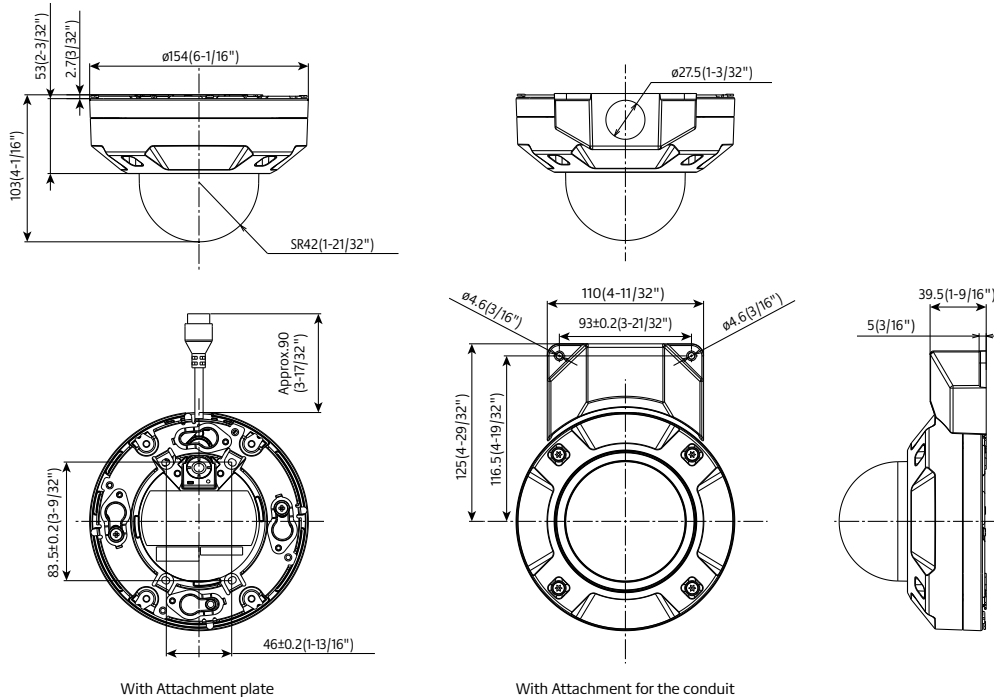







<b>Network</b>	Network IF	10Base-T / 100Base-TX, RJ45 connector				
	Resolution H.265/H.264	<b>[16:9 mode(2688x1520 30fps mode)], [16:9 mode(2688x1520 25fps mode)]</b> 2688x1520, 1920x1080, 640x360, 320x180 <b>[16:9 mode(30fps mode)], [16:9 mode(25fps mode)]</b> 2560x1440, 1920x1080, 640x360, 320x180 * [4:3 mode] is not supported.				
	H.265 / H.264	Transmission Mode	Constant bit rate / VBR / Frame rate / Best effort			
		Transmission Type	Unicast / Multicast			
	H.265 / H.264	Max. frame rate for each stream*2	Stream(1)	Stream(2)	Stream(3)	JPEG(1)
			2688x1520(30fps)	Off	Off	2560x1440(1fps)
	JPEG	Image Quality	2560x1440(30fps)	640x360(30fps)	Off	1920x1080(1fps)
			1920x1080(30fps)	1920x1080(30fps)	640x360(10fps)	2560x1440(1fps)
	Smart Coding	GOP(Group of pictures) control:	On(Frame rate control) / On(Advanced) / On(Mid) / On(Low) / Off			
			*Frame rate control and Advanced are only available with H.265.			
	Audio Compression	Audio transmission mode	—			
			Supported Protocol			
	No. of Simultaneous Users	SDXC/SDHC/SD Memory Card	IPV6 : TCP/IP, UDP/IP, HTTP, HTTPS, SSL/TLS, SMTP, DNS, NTP, SNMPv1/v2/v3, DHCPv6, RTP, MLD, ICMP, ARP, IEEE 802.1X, DiffServ, MQTT*3, LLDP*3 IPV4 : TCP/IP, UDP/IP, HTTP, HTTPS, SSL/TLS, RTSP, RTP, RTP/RTCP, SMTP, DHCP, DNS, DDNS, NTP, SNMPv1/v2/v3, UPnP, IGMP, ICMP, ARP, IEEE 802.1X, DiffServ, MQTT*3, LLDP*3			
			Up to 14 users (Depends on network conditions)			
	Mobile Terminal Compatibility	ONVIF® Profile	H.265/H.264 recording: Manual REC / Alarm REC (Pre/Post) / Schedule REC			
Compatible SDXC/SDHC/SD Memory Card : microSDXC memory card: 64 GB, 128 GB, 256 GB, 512 GB microSDHC memory card: 4 GB, 8 GB, 16 GB, 32 GB microSD memory card: 2 GB						
Alarm	Alarm Source	iPad, iPhone, Android™ terminals				
		G / S / T				
Input/Output	Monitor Output(for adjustment)	—				
		—				
<b>General</b>	Safety	UL (UL60950-1), c-UL (CSA C22.2 No.60950-1), CE, IEC60950-1				
		EMC				
	Power Source and Power Consumption	FCC (Part15 ClassA), ICES003 ClassA, EN55032 ClassB, EN55024				
		PoE (IEEE802.3af compliant) Device: DC48 V 150 mA, Approx. 7.2 W (Class 0 device)				
	Ambient Operating Temperature	-30 °C to +50 °C (-22 °F to +122 °F) {Power On range: -20 °C to +50 °C (-4 °F to +122 °F)}				
		Ambient Operating Humidity				
	Anti-Condensation System	10 to 100 % (no condensation)				
		Temish element				
	Water and Dust Resistance*4	IP66 (IEC 60529), Type 4X (UL50E), NEMA 4X compliant				
		Shock Resistance				
Dimensions	IK10 (IEC 62262)					
	ø154 mm (W) x 103 mm (H) (ø6-1/16 inches x 4-1/16 inches (H)) Dome radius 42 mm (1-21/32 inches)					
Mass (approx.)	1.0 kg (2.21 lbs.)					
	Finish					
Main body: Aluminum die cast/ PC resin, i-PRO white Outer fixing screws: Stainless steel (Corrosion-resistant treatment) Dome cover: Polycarbonate resin, Clear						











# Appearance



# Optional Accessories

## Mount Bracket / Other

WALL			POLE		CORNER	
1	2	3	1	2	1	2
Wall Mount Bracket <b>PWM485W</b> (White) 	Wall Mount Bracket <b>WV-QWL500-W</b> (White) 	Sun Shade <b>WV-QSR500-W</b> (White) 	Pole Mount Bracket <b>PAPM4W</b> (White) 		Corner Mount Bracket <b>PACA4W</b> (White) 	
Conduit Adapter <b>PAPM6</b> (Black) 	Adapter Box <b>WV-QJB500-W</b> (White) 	Base Bracket <b>WV-QJB501-W</b> (White) 	Wall Mount Bracket <b>PWM485W</b> (White) 	Wall Mount Bracket <b>WV-QWL500-W</b> (White) (+ <b>WV-QJB500-W</b> ) 	Wall Mount Bracket <b>PWM485W</b> (White) 	Wall Mount Bracket <b>WV-QWL500-W</b> (White) (+ <b>WV-QJB500-W</b> ) 
*If needed.						

HANGING			PARAPET	CEILING		
1	2	3	1	1	2	3
Ceiling Mount Bracket <b>WV-QCL501-W</b> (White) 	Ceiling Mount Bracket <b>WV-QCL101-W</b> (White) *For indoor installation only. 	Ceiling Mount Bracket <b>WV-QCL101-W</b> *1 (White) *For indoor installation only. 	Parapet Mount Bracket <b>PPRM35W</b> (White) 	Ceiling Mount Bracket (Embedded) <b>WV-QEM500-W</b> (White) 	Base Bracket <b>WV-QJB501-W</b> (White) 	Ceiling Mount Bracket <b>WV-Q105A</b> *For indoor installation only. 
Mount Bracket <b>WV-QSR501-W</b> (White) 	Mount Bracket <b>PS485W</b> (White) 	This bracket requires 1 1/2" NPT pipe. 	Mount Bracket <b>PS485W</b> (White) 			

\*1: It's possible to be used on the camera side and ceiling side. If used on both side, 2pieces are required.

## Dome Cover

Dome Cover (Smoke type) <b>WV-CW7S</b> 	Dome Cover (Smoke type with ClearSight coating) <b>WV-CW7SN</b> 	Dome Cover (Clear type with ClearSight coating) <b>WV-CW7CN</b> 
---	--	--

### Trademarks and registered trademarks

- iPad and iPhone are trademarks of Apple Inc., registered in the U.S. and other countries.
- Android is a trademark of Google LLC.
- ONVIF is a trademark of ONVIF, Inc.
- All other trademarks identified herein are the property of their respective owners.

### Important

- Safety Precautions : Carefully read the Basic Information, Installation Guide and Operating Instructions before using this product.
- i-PRO Co., Ltd. cannot be held responsible for the performance of the network and/or other manufacturers' products used on the network.

• Masses and dimensions are approximate. • Specifications are subject to change without notice.