

## New U-series compact network camera with enhanced functions and affordability

# 2MP (1080p) Varifocal Lens Outdoor Dome Network Camera

The new U series is an entry model that achieves high quality and reliability at an affordable price to meet the needs of a wide range of customers. The compact and slim design allows it to be installed in a various locations.

It newly supports ONVIF G / S / T profile and H.265 / H.264, and can be widely used for connecting various VMS and recorders. It also comes pre-installed with secure certificates, enabling device authentication and end-to-end communication encryption to counter the threat of advanced cyberattacks.

### Key features

- Compact and slim design allows installation in various locations
- Compliant with ONVIF G / S / T profile and H.265 / H.264, and can support a wide range of connections to VMS and recorders
- Uses "Easy Kitting Packing" that allows you to set the camera without removing it from the box
- Strengthen cyber security by pre-installing digital certificates issued by a third party organization (GlobalSign)

### Key i-PRO Spec.

- 2MP (1080p) up to 30fps
- 2.5x built-in motorized zoom and motorized focus lens
- iA (intelligent Auto)
- Super Dynamic 120dB
- Color night vision (0.006 to 0.1 lx)
- H.265 Smart Coding
- Corridor mode  
(90 degrees or 270 degrees in image rotation)
- Built-in IR LED
- ONVIF® Profile G / S / T  
\*ONVIF is a trademark of ONVIF, Inc.
- Genetec Stratocast compatible

### Industry examples

- Safe Cities
- Transportation (Airport / Train, Subway station)
- Bank (ATM, Entrance)
- Retail / Logistics / Education / Hospital / Building



## Specifications

<b>Camera</b>	Image Sensor	Approx. 1/3 type CMOS image sensor	
	Minimum Illumination	Color : 0.1 lx, BW: 0.04 lx (50IRE, F2.0, Maximum shutter: Off (1/30s), AGC: 11) BW : 0 lx {0 footcandle} (50IRE, F2.0, Maximum shutter: Off (1/30 s), AGC: 11, when the IR LED is lit) Color : 0.006 lx, BW: 0.0025 lx (50IRE, F2.0, Maximum shutter: max. 16/30s, AGC: 11)*1	
	White Balance	ATW1/ ATW2/ AWC	
	Maximum shutter	<b>[30fps mode]</b> Max. 1/10000 s to Max. 16/30 s <b>[25fps mode]</b> Max. 1/10000 s to Max. 16/25 s	
	Intelligent Auto	On / Off	
	Super Dynamic	On / Off, The level can be set in the range of 0 to 31.	
	Dynamic Range	Max.120 dB (Super Dynamic: On, Level: 31)	
	Adaptive Black Stretch	—	
	Back light compensation / High light compensation	BLC/ HLC/ Off (only when Super Dynamic/ Intelligent auto: Off)	
	Fog compensation	On / Off, The level can be set in the range of 0 to 8. (only when intelligent auto / auto contrast adjust: Off)	
	Maximum gain (AGC)	The level can be set in the range of 0 to 11.	
	Color/BW (ICR)	Off/ On (IR Light Off) / On (IR Light On)/Auto1 (IR Light Off) / Auto2 (IR Light On) / Auto3 (SCC)	
	IR LED Light	High/ Middle/ Low/ Off Maximum irradiation distance: 30 m {Approx. 100 ft}	
	Digital Noise Reduction	The level can be set in the range of 0 to 255.	
	Video Motion Detection (VMD)	On / Off, 4 areas available	
	Scene Change Detection(SCD)	On / Off, 1 areas available	
	Privacy Zone	On / Off, Up to 8 zones available	
	Image rotation*2	0° (Off) / 90° / 180° (Upside-down) / 270°	
	Camera Title (OSD)	On / Off, Up to 20 characters (alphanumeric characters, marks)	
	<b>Lens</b>	Focal length	2.9 mm – 7.3 mm (1/8inches-9/32inches)
Optical zoom		2.5x (Motorized zoom / Motorized focus)	
Extra optical zoom		2.5x - 3.8x (when resolution is 1280x720)	
Digital (electronic) zoom		Choose from 3 levels of x1, x2, x4	
Angular Field of View		<b>[16 : 9 mode]</b> Horizontal : 42° (TELE) – 97° (WIDE), Vertical : 23° (TELE) – 54° (WIDE) <b>[4 : 3 mode]</b> Horizontal : 31° (TELE) – 72° (WIDE), Vertical : 23° (TELE) – 54° (WIDE)	
Maximum Aperture Ratio		1 : 2.0 (WIDE) – 1 : 3.0 (TELE)	
Focus range		1 m {39-3/8 inches} – ∞	
<b>DORI</b>		Detect (25ppm / 8ppf)	Wide: 36.8 m / 120.8 ft, Tele: 101.5 m / 333.0 ft
		Observe (62.5ppm / 19ppf)	Wide: 14.7 m / 48.3 ft, Tele: 40.6 m / 133.2 ft
		Recognize (125ppm / 38ppf)	Wide: 7.4 m / 24.2 ft, Tele: 20.3 m / 66.6 ft
	Identify (250ppm / 76ppf)	Wide: 3.7 m / 12.1 ft, Tele: 10.1 m / 33.3 ft	
<b>Adjusting Angle</b>	Ceiling mounting	—	
	Wall mounting	—	
<b>Browser GUI</b>	Camera Control	Brightness	
	GUI / Setup Menu Language	English, Italian, French, German, Spanish, Portuguese, Russian, Chinese, Japanese	

\*1 Converted value  
\*2 When "4:3(30fps mode)" or "4:3(25fps mode)" is selected for "Image capture mode", "90 °" and "270 °" cannot be selected.  
\*3 Smart Coding(GOP and AUTO VIQS) is not available when setting 30fps.  
\*4 It may be necessary to upgrade the firmware to use these protocols.  
\*5 Only when installation work is properly performed according to the Installation Guide and appropriate waterproof treatment is performed.





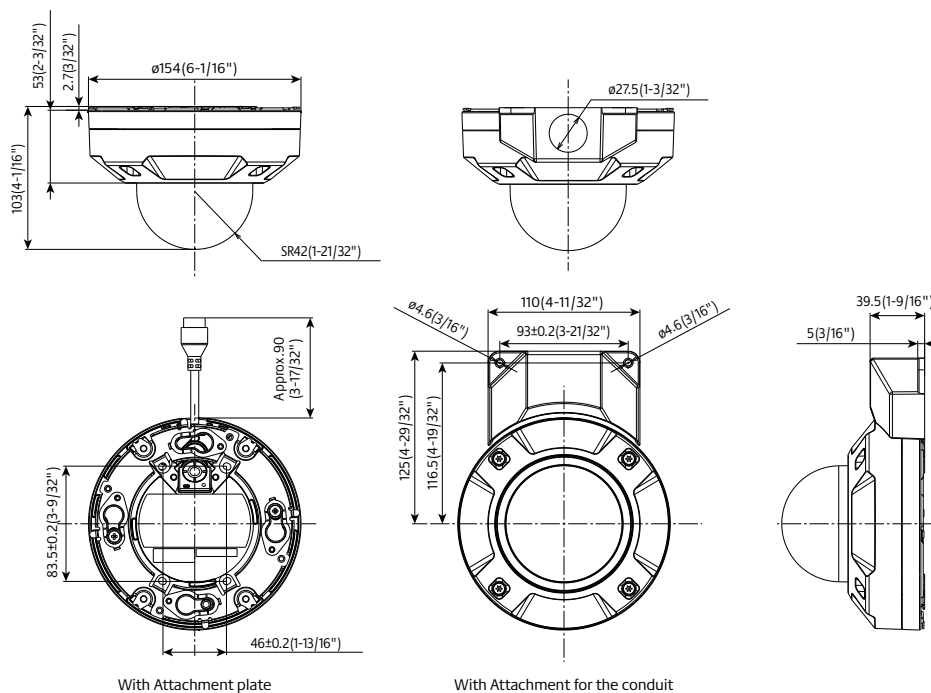







<b>Network</b>	Network IF	10Base-T / 100Base-TX, RJ45 connector					
	Resolution	<b>[16 : 9 mode]</b> 1920x1080, 1280x720, 640x360, 320x180 <b>[4 : 3 mode]</b> 1280x1200, 1280x960, VGA, QVGA					
	H.265/H.264	Constant bit rate / VBR / Frame rate / Best effort					
	H.264	Transmission Mode	Unicast / Multicast				
		Transmission Type Max. frame rate for each stream*3	<b>Stream(1)</b>	<b>Stream(2)</b>	<b>Stream(3)</b>	<b>JPEG(1)</b>	<b>JPEG(2)</b>
			1920x1080(30fps)	640x360(30fps)	Off	1920x1080(1fps)	1280x720(1fps)
			1280x720(30fps)	1280x720(30fps)	Off	1920x1080(1fps)	1280x720(1fps)
	1600x1200(30fps)	640x480(30fps)	Off	1600x1200(1fps)	1280x960(1fps)		
	JPEG	Image Quality	10 steps				
	Smart Coding	<b>GOP(Group of pictures) control:</b> On(Frame rate control) / On(Advanced) / On(Mid) / On(Low) / Off *Frame rate control and Advanced are only available with H.265. <b>AUTO VIQS:</b> On/ Off					
		Audio Compression	—				
	Audio transmission mode		—				
	Supported Protocol	IPv6 : TCP/IP, UDP/IP, HTTP, HTTPS, SSL/TLS, SMTP, DNS, NTP, SNMPv1/v2/v3, DHCPv6, RTP, MLD, ICMP, ARP, IEEE 802.1X, DiffServ, MQTT*4, LLDP*4					
		IPv4 : TCP/IP, UDP/IP, HTTP, HTTPS, SSL/TLS, RTSP, RTP, RTMP/RTCP, SMTP, DHCP, DNS, DDNS, NTP, SNMPv1/v2/v3, UPnP, IGMP, ICMP, ARP, IEEE 802.1X, DiffServ, MQTT*4, LLDP*4					
		No. of Simultaneous Users Up to 14 users (Depends on network conditions)					
Memory Card	SDXC/SDHC/SD Memory Card : Compatible SDXC/SDHC/SD Memory Card : microSDXC memory card: 64 GB, 128 GB, 256 GB, 512 GB microSDHC memory card: 4 GB, 8 GB, 16 GB, 32 GB microSD memory card: 2 GB						
	Mobile Terminal Compatibility	iPad, iPhone, Android™ terminals					
<b>Alarm</b>	ONVIF® Profile	G / S / T					
	Alarm Source	VMD alarm, SCD alarm, Command alarm					
	Alarm Actions	SDXC/SDHC/SD memory recording, E-mail notification, HTTP alarm notification Indication on browser, TCP alarm notification output					
<b>Input/Output</b>	Monitor Output(for adjustment)	—					
	Audio input / Audio Output External I/O Terminals	—					
<b>General</b>	Safety	UL (UL60950-1), c-UL (CSA C22.2 No.60950-1), CE, IEC60950-1					
	EMC	FCC (Part15 ClassA), ICES003 ClassA, EN55032 ClassB, EN55024					
	Power Source and Power Consumption	PoE (IEEE802.3af compliant) Device: DC48 V 140 mA, Approx. 6.7 W (Class 0 device)					
	Ambient Operating Temperature	-30 °C to +50 °C (-22 °F to +122 °F)					
	Ambient Operating Humidity	{Power On range: -20 °C to +50 °C (-4°F to +122 °F)}					
	Anti-Condensation System	Temish element					
	Water and Dust Resistance*5	IP66 (IEC 60529), Type 4X (UL50E), NEMA 4X compliant					
	Shock Resistance	IK10 (IEC 62262)					
	Dimensions	ø154 mm (W) x 103 mm (H) {ø6-1/16 inches x 4-1/16 inches (H)} Dome radius 42 mm (1-21/32 inches)					
	Mass (approx.)	1.0 kg (2.21 lbs.)					
Finish	Main body: Aluminum die cast/ PC resin, i-PRO white Outer fixing screws: Stainless steel (Corrosion-resistant treatment) Dome cover: Polycarbonate resin, Clear						

## Appearance







## Optional Accessories

### Mount Bracket / Other

	WALL			POLE	CORNER	HANGING	
	1	2	3	1	1	1	2
combination	Wall Mount Bracket <b>WV-QWL501-W</b> (i-PRO white) 	Wall Mount Bracket <b>WV-QWL500-W</b> (i-PRO white) 	Sun Shade <b>WV-QSR500-W</b> (i-PRO white) 	Pole Mount Bracket <b>WV-QPL500-W</b> (i-PRO white) 	Corner Mount Bracket <b>WV-QCN500-W</b> (i-PRO white) 	Ceiling Mount Bracket <b>WV-QCL501-W</b> (i-PRO white) 	Ceiling Mount Bracket <b>WV-QCL100-W</b> *1 (i-PRO white)  <small>*For indoor installation only.</small>
	Mount Bracket <b>WV-QSR501-W</b> (i-PRO white) 	Adapter Box <b>WV-QJB500-W</b> (i-PRO white)  <small>*If needed.</small>	Base Bracket <b>WV-QJB501-W</b> (i-PRO white) 	Wall Mount Bracket <b>WV-QWL500-W</b> (i-PRO white) (+ <b>WV-QJB500-W</b> ) 	Wall Mount Bracket <b>WV-QWL500-W</b> (i-PRO white) (+ <b>WV-QJB500-W</b> ) 	Mount Bracket <b>WV-QSR501-W</b> (i-PRO white) 	3rd. parties pipe

\*1: It's possible to be used on the camera side and ceiling side. If used on both side, 2pieces are required.

	CEILING			OTHER
	1	2	3	1
combination	Ceiling Mount Bracket (Embedded) <b>WV-QEM500-W</b> (i-PRO white) 	Base Bracket <b>WV-QJB501-W</b> (i-PRO white) 	Ceiling Mount Bracket <b>WV-Q105A</b>  <small>*For indoor installation only.</small>	Attachment pipe (For 3rd party bracket) <b>WV-QAT500-W</b> (i-PRO white) 

### Dome Cover

Dome Cover (Smoke type) <b>WV-CW7S</b> 	Dome Cover (Smoke type with ClearSight coating) <b>WV-CW7SN</b> 	Dome Cover (Clear type with ClearSight coating) <b>WV-CW7CN</b> 
---	--	--

#### Trademarks and registered trademarks

- iPad and iPhone are trademarks of Apple Inc., registered in the U.S. and other countries.
- Android is a trademark of Google LLC.
- ONVIF is a trademark of ONVIF, Inc.
- All other trademarks identified herein are the property of their respective owners.

#### Important

- Safety Precautions : Carefully read the Basic Information, Installation Guide and Operating Instructions before using this product.
- i-PRO Co., Ltd. cannot be held responsible for the performance of the network and/or other manufacturers' products used on the network.

• Masses and dimensions are approximate. • Specifications are subject to change without notice.