

New U-series compact network camera with enhanced functions and affordability

2MP (1080p) Indoor Dome Network Camera

The new U series is an entry model that achieves high quality and reliability at an affordable price to meet the needs of a wide range of customers. The compact and slim design allows it to be installed in a various locations.

It newly supports ONVIF G / S / T profile and H.265 / H.264, and can be widely used for connecting various VMS and recorders. It also comes pre-installed with secure certificates, enabling device authentication and end-to-end communication encryption to counter the threat of advanced cyberattacks.

Key features

- Compact and slim design allows installation in various locations
- Compliant with ONVIF G / S / T profile and H.265 / H.264, and can support a wide range of connections to VMS and recorders
- Uses "Easy Kitting Packing" that allows you to set the camera without removing it from the box
- Strengthen cyber security by pre-installing digital certificates issued by a third party organization (GlobalSign)

Key i-PRO Spec.

- 2MP (1080p) up to 30fps
- iA (intelligent Auto)
- Super Dynamic 120dB
- Color night vision (0.006 to 0.1 lx)
- H.265 Smart Coding
- Corridor mode
(90 degrees or 270 degrees in image rotation)
- Built-in IR LED
- ONVIF® Profile G / S / T
*ONVIF is a trademark of ONVIF, Inc.
- Genetec Stratocast compatible

Industry examples

- Retail
- Education
- Public safety
- Bank / Hospital / Building



Specifications

Camera	Image Sensor	Approx. 1/3 type CMOS image sensor
	Minimum Illumination	Color : 0.1 lx, BW : 0.04 lx (50IRE, F2.0, Maximum shutter : Off (1/30s), AGC : 11) BW : 0 lx (50IRE, F2.0, Maximum shutter : Off (1/30 s), AGC : 11, when the IR LED is lit) Color : 0.006 lx, BW : 0.0025 lx (50IRE, F2.0, Maximum shutter : max. 16/30s, AGC : 11) *1
	White Balance	ATW1/ ATW2/ AWC
	Maximum shutter	[30fps mode] Max. 1/10000 s to Max. 16/30 s [25fps mode] Max. 1/10000 s to Max. 16/25 s
	Intelligent Auto	On / Off
	Super Dynamic	On / Off, The level can be set in the range of 0 to 31.
	Dynamic Range	Max. 120 dB (Super Dynamic : On, Level: 31)
	Adaptive Black Stretch	The level can be set in the range of 0 to 255.
	Back light compensation / High light compensation	BLC (Back light compensation) / HLC (High light compensation) / Off The level can be set in the range of 0 to 31. (only when Super dynamic / Intelligent Auto : Off)
	Fog compensation	On / Off, The level can be set in the range of 0 to 8. (only when Intelligent auto / auto contrast adjust: Off)
	Maximum gain (AGC)	The level can be set in the range of 0 to 11.
	Color/BW (ICR)	Off / On (IR Light Off) / On (IR Light On) / Auto1 (IR Light Off) / Auto2 (IR Light On) / Auto3 (SCC)
	IR LED Light	High / Middle / Low / Off, Maximum irradiation distance : 30 m (Approx. 100 ft)
	Digital Noise Reduction	The level can be set in the range of 0 to 255.
	Video Motion Detection (VMD)	On / Off, 4 areas available
	Scene Change Detection (SCD)	On / Off, 1 area available
	Privacy Zone	On / Off, Up to 8 zones available
	VIQS	On / Off, Up to 8 zones available
	Image rotation ²	0° (Off) / 90° / 180° (Upside-down) / 270°
	Camera Title (OSD)	On / Off, Up to 20 characters (alphanumeric characters, marks)
Lens	Focal length	3.2 mm (1/8 inches)
	Optical zoom	1x
	Extra zoom	1.0x - 1.5x (when resolution is 1280x720)
	Digital (electronic) zoom	Choose from 3 levels of x1, x2, x4
	Angular Field of View	[16 : 9 mode] Horizontal : 97° Vertical : 53° [4 : 3 mode] Horizontal : 71° Vertical : 53°
	Maximum Aperture Ratio	1 : 2.0
	Focus range	1 m (39-3/8 inches) - ∞
DORI	Detect (25ppm / 8ppf)	37.5 m / 122.9 ft
	Observe (62.5ppm / 19ppf)	15.0 m / 49.2 ft
	Recognize (125ppm / 38ppf)	7.5 m / 24.6 ft
	Identify (250ppm / 76ppf)	3.7 m / 12.3 ft
Adjusting Angle	Horizontal (PAN) angle: -175° ~ +175°, Vertical (TILT) angle: -30° ~ +80° Azimuth (YAW) angle: ±100°	
Browser	Camera Control Brightness	
GUI	GUI /	English, Italian, French, German, Spanish, Portuguese, Russian,
	Setup Menu Language	Chinese, Japanese

Network	Network IF	10Base-T / 100Base-TX, RJ45 connector				
	Resolution	[16 : 9 mode] 1920×1080, 1280×720, 640×360, 320×180 [4 : 3 mode] 1600×1200, 1280×960, VGA, QVGA				
	H.265/H.264	Constant bit rate / VBR / Frame rate / Best effort				
	H.265/	Transmission Mode	Unicast port(AUTO) / Unicast port(MANUAL) / Multicast			
	H.264	Transmission Type	Unicast port(AUTO) / Unicast port(MANUAL) / Multicast			
		Max. frame rate for each stream ³	Stream(1) 1920x1080(30fps) 1280x720(30fps) 1600x1200(30fps)	Stream(2) 640x360(30fps) 1280x720(30fps) 640x480(30fps)	Stream(3) Off	JPEG(1) 1920x1080(1fps) 1280x720(1fps) 1600x1200(1fps)
	JPEG	Image Quality	10 steps			
		Smart Coding	GOP(Group of pictures) control: On(Frame rate control) / On(Advanced) / On(Mid.) / On(Low) / Off *Frame rate control and Advanced are only available with H.265. AUTO VIQS: On / Off			
		Audio Compression	—			
		Audio transmission mode	—			
		Supported Protocol	IPv6 : TCP/IP, UDP/IP, HTTP, HTTPS, SSL/TLS, SMTP, DNS, NTP, SNMPv1/v2/v3, DHCPv6, RTP, MLD, ICMP, ARP, IEEE 802.1X, DiffServ, MQTT ⁴ , LLDP ⁴ IPv4 : TCP/IP, UDP/IP, HTTP, HTTPS, SSL/TLS, RTSP, RTP, RTP/RTCP, SMTP, DHCP, DNS, DDNS, NTP, SNMPv1/v2/v3, UPnP, IGMP, ICMP, ARP, IEEE 802.1X, DiffServ, MQTT ⁴ , LLDP ⁴			
		No. of Simultaneous Users	Up to 14 users (Depends on network conditions)			
		SDXC/SDHC/SD Memory Card	H.265/H.264 recording: Manual REC / Alarm REC (Pre/Post) / Schedule REC Compatible SDXC/SDHC/SD Memory Card : microSDXC memory card: 64 GB, 128 GB, 256 GB, 512 GB microSDHC memory card: 4 GB, 8 GB, 16 GB, 32 GB microSD memory card: 2 GB			
		Mobile Terminal Compatibility	iPad, iPhone, Android™ terminals			
		ONVIF [®] Profile	G / S / T			
Alarm	Alarm Source	VMD alarm, SCD alarm, Command alarm				
	Alarm Actions	SDXC/SDHC/SD memory recording, E-mail notification, HTTP alarm notification, Indication on browser, TCP alarm notification output				
Input/ Output	Monitor Output (for adjustment)	—				
	Audio input	—				
	Audio Output	—				
	External I/O Terminals	—				
General	Safety	UL (UL60950-1), c-UL (CSA C22.2 No.60950-1), CE, IEC60950-1				
	EMC	FCC (Part15 ClassA), ICES003 ClassA, EN55032 ClassB, EN55024				
	Power Source and Power Consumption	PoE (IEEE802.3af compliant) Device : DC48 V 100 mA, Approx. 4.8 W (Class 2 device)				
	Ambient Operating Temperature	-10 °C to +50 °C (+14 °F to +122 °F)				
	Ambient Operating Humidity	10 to 90 % (no condensation)				
	Dimensions	ø109 mm x 62 mm (H) {ø4-9/32 inches x 2-7/16 inches (H)} Dome radius 30.5 mm {1-3/16 inches}				
	Mass (approx.)	250 g {0.55 lbs}				
	Finish	Main body : Aluminum die cast / Polycarbonate resin, i-PRO white Dome section : Polycarbonate resin, Clear				

*1 Converted value

*2 When "4:3(30fps mode)" or "4:3(25fps mode)" is selected for "Image capture mode", "90 °" and "270 °" cannot be selected.

*3 Smart Coding(GOP and AUTO VIQS) is not available when setting 30fps.

*4 It may be necessary to upgrade the firmware to use these protocols.





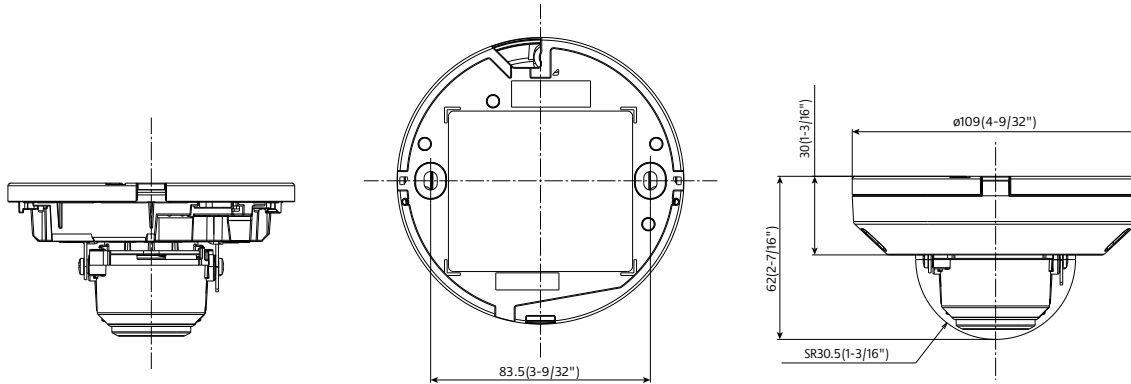

Appearance

Unit : mm (inches)



Optional Accessories

Mount Bracket / Other

		WALL		POLE	CORNER
		1	2	1	1
combination	Wall Mount Bracket WV-QWL500-W (White) 	Base bracket WV-QJB502-W (White) 	Pole Mount Bracket PAPM4W (White) 		Corner Mount Bracket PACA4W (White) 
	Adapter Box WV-QJB500-W (White)  *If needed.	/		Wall Mount Bracket WV-QWL500-W (White) (+ WV-QJB500-W) 	Wall Mount Bracket WV-QWL500-W (White) (+ WV-QJB500-W) 

		HANGING	CEILING	DOUBLE/OCTAGON GANG BOX
		1	1	1
combination	Ceiling Mount Bracket WV-QCL101-W *1 (White) 	Base bracket WV-QJB502-W (White) 	Gangbox Adapter WV-QAT502-W (White) 	
	This bracket requires 1 1/2" NPT pipe.			

*1: It's possible to be used on the camera side and ceiling side. If used on both side, 2pieces are required.

Dome Cover

Dome Cover (Smoke type)
WV-QDC500S



Trademarks and registered trademarks

- iPad and iPhone are trademarks of Apple Inc., registered in the U.S. and other countries.
- Android is a trademark of Google LLC.
- ONVIF is a trademark of ONVIF, Inc.
- All other trademarks identified herein are the property of their respective owners.

Important

- Safety Precautions : Carefully read the Basic Information, Installation Guide and Operating Instructions before using this product.
- i-PRO Co., Ltd. cannot be held responsible for the performance of the network and/or other manufacturers' products used on the network.

• Masses and dimensions are approximate. • Specifications are subject to change without notice.