

12MP Sensor Vandal Resistant Outdoor 360-degree Fisheye Network Camera

Panasonic WV-X4573L captures the highest quality images in even very challenging and dynamic environments.

In particular, the image of the person's face or object at the edge of the fisheye is clear with less distortion.

Intelligent Auto (iA) monitors scene dynamics and motion to adjust key camera settings automatically in real-time reducing distortion such as motion blur on moving objects. Adopting H.265 Smart Coding technology, bandwidth efficiency is intelligently increased for longer recording and less storage. Cameras out-of-the-box, use an encryption module standardized by FIPS Publication 140-2 for secure video streaming.

Extreme image quality for evidence capturing under challenging conditions

- Clear and less distorted image of the person's face and objects at the edge of the fisheye
- Instant response to sudden light changes like tunnel entry and exit
- Auto Shutter speed control for fast moving objects
- Built-in IR LED to produce a clear monochrome image in zero lux conditions with 10 m (33 feet) irradiation distance
- Environmental durability : EN50155, IP66, IK10, 50J compliant and Dehumidification device

Extreme bandwidth compression with new Panasonic H.265 Smart Coding

- Longer recording and less storage space compared to any H.264 based compression techniques
- New self-learning ROI* encoding (Auto VIQS) dynamically detects motion areas to keep vehicles and humans in good picture quality while lowering your bandwidth *Region of Interest

Extreme Data Security

- Full encryption SD card edge recording to keep your data safe
- FIPS140-2 CAVP compliant *Using encryption module standardized by FIPS publication 140-2
- Full end-to-end system encryption with supported VMS and devices to protect from IP snooping/spoofing and detect data alteration

Complete with powerful analytics built-in

- Heat map : Visualization of people's traffic pattern and staying times
- People Counting : Statistics data on the number of people entering and leaving a specific zone
- MOR (Moving Object Remover) : Monitoring of only the surrounding environment by removing people and other moving objects from video

Key Features

- 12MP Sensor
- 2992x2992 pixel fisheye images up to 30fps
- iA (intelligent Auto)
- H.265 Smart Coding
- ABF (Auto Back Focus)
- IP66, IK10, 50J compliant, Dehumidification device
- i-VMD License Bundled
- Fiber Optic Media Converter Unit (Optional WV-S25F1)
- Onvif Profile G / S / T



with Base Bracket

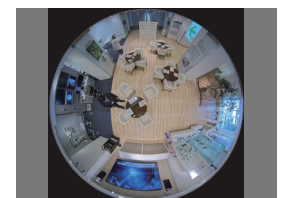

2992 x 2992
4000 x 3000

Industry examples

- Transportation (Airport / Train, Subway station)
- Retail / Bank
- Logistics / Factory
- Building
- Education / Hospital

Specifications

Camera	Image Sensor	Approx. 1/2 type 12MP CMOS image sensor	
	Minimum Illumination	Color : 0.3 lx, BW : 0.04 lx (F1.9, Maximum shutter : Off (1/30 s), AGC : 11) BW : 0 lx (F1.9, Maximum shutter : Off (1/30 s), AGC : 11, when the IR LED is lit) Color : 0.02 lx, BW : 0.003 lx (F1.9, Maximum shutter : max. 16/30s, AGC : 11) *1	
	Intelligent Auto	On / Off	
	Maximum shutter	Max.16/30s to Max. 1/10000s	
	Wide Dynamic Range ²	On / Off, The level can be set in the range of 0 to 31.	
	Dynamic Range	Max.84 dB (Wide Dynamic Range : On, level : 31)	
	Image Settings	Gain (AGC), White balance	
	Image Compensation	Adaptive black stretch, Back light compensation (BLC), Fog compensation, High light compensation (HLC), Digital noise reduction	
	Color/BW (ICR)	Off / On (IR Light Off) / On (IR Light On) / Auto1 (IR Light Off) / Auto2 (IR Light On) / Auto3 (SCC)	
	IR LED Light	High* / Middle / Low / Off *Maximum irradiation distance : 10 m (Approx. 33 ft) (Mounting height : Approx. 3 m, Peripheral intensity control : On)	
	Video Motion Detection (VMD)	On / Off, 4 areas available	
	Intelligent VMD (i-VMD) ³	Type 8 *Bundled License	
	Privacy Zone	On / Off, Up to 8 zones available	
	Camera Title (OSD)	On / Off, Up to 20 characters (alphanumeric characters, marks)	
	Fixing angle adjustment	-5°, 0°, +5°	
Lens	Zoom Ratio	1x	
	Digital (electronic) zoom	Choose from 3 levels of x1, x2, x4	
	Focal length	1.4 mm (1/16 inches)	
	Maximum Aperture Ratio	1 : 1.9	
	Focus range	0.5 m (1/11/16 inches) - ∞	
	Angular Field of view	Horizontal : 183° Vertical : 183°	
DORI	Distance to the object in the center of the image	Detect (25 ppm / 8 ppf) : 29.9 m / 98.2 ft	
		Observe (62.5 ppm / 19 ppf) : 12.0 m / 39.3 ft	
		Recognize (125 ppm / 38 ppf) : 6.0 m / 19.6 ft	
	Coverage radius when mounted at a height of 3 m (10 ft)	Detect (25 ppm / 8 ppf) : 56.1 m / 184.2 ft	
		Observe (62.5 ppm / 19 ppf) : 20.6 m / 67.6 ft	
		Recognize (125 ppm / 38 ppf) : 8.4 m / 27.6 ft	
Identify (250 ppm / 76 ppf) : 0.3 m / 0.9 ft			
Browser GUI	Camera Control	Brightness, AUX On / Off	
	Audio	Mic (Line) Input : On / Off Volume adjustment : Low / Middle / High Audio Output : On / Off Volume adjustment : Low / Middle / High	
	GUI / Setup Menu Language	English, Italian, French, German, Spanish, Portuguese, Russian, Chinese, Japanese	
	Network IF	10Base-T / 100Base-TX, RJ45 connector	
Network	Resolution	<Ceiling> •Fisheye mode (max. 30 fps/25 fps) 2992x2992 / 2192x2192 / 1280x1280 / 640x640 / 320x320 <Wall> •Quad PTZ mode (max. 15 fps/12.5 fps), Single PTZ mode (max. 15 fps/12.5 fps) 2560x1920 ⁴ / 2048x1536 / 1600x1200 / 1280x960 / 800x600 / VGA / QVGA	
		<Ceiling> •Double Panorama mode (max. 15 fps/12.5 fps) 2560x1440 / 1920x1080 / 1280x720 / 640x360 / 320x180 •Fisheye + Double Panorama mode (max. 15 fps/12.5 fps) (Fisheye) 2992x2992 / 2192x2192 / 1280x1280 / 640x640 / 320x320 (Double Panorama) 1280x720 / 640x360 / 320x180 •Fisheye + Quad PTZ mode (max. 15 fps/12.5 fps) (Fisheye) 2992x2992 / 2192x2192 / 1280x1280 / 640x640 / 320x320 (Quad PTZ) 1280x960 / 800x600 / VGA / QVGA •Quad streams mode (Single PTZ (Quad streams)) 1280x960 / 800x600 / VGA / QVGA (max. 15 fps/12.5 fps) (Quad PTZ) 2560x1920 / 2048x1536 / 1600x1200 / 1280x960 / 800x600 / VGA / QVGA (max. 5 fps)	
		<Wall> •Panorama mode (max. 15 fps/12.5 fps) 2560x1440 / 1920x1080 / 1280x720 / 640x360 / 320x180 •Fisheye + Panorama mode (max. 15 fps/12.5 fps) (Fisheye) 2992x2992 / 2192x2192 / 1280x1280 / 640x640 / 320x320 (Panorama) 1280x720 / 640x360 / 320x180	
	H.265/ H.264 ⁵	Transmission Mode Constant bit rate / VBR / Frame rate / Best effort	
	JPEG	Transmission Type Unicast port (AUTO)/ Unicast port (MANUAL)/ Multicast	
		Image Quality 10 steps	

Network	Smart Coding	GOP (Group of pictures) control : On (Frame rate control) / On (Advanced) / On (Mid) / On (Low) / Off *On (Frame rate control) and On (Advanced) are only available with H.265. Auto IQS : On / Off
	Audio Compression	G.726 (ADPCM) : 16 kbps / 32 kbps G.711 : 64 kbps AAC-LC ⁶ : 64 kbps / 96 kbps / 128 kbps
	Supported Protocol	IPv6 : TCP/IP, UDP/IP, HTTP, HTTPS, SMTP, DNS, NTP, SNMP, DHCPv6, RTP, MLD, ICMP, ARP, IEEE 802.1X, DiffServ, SSL/TLS ⁸ , SRTP ⁸ , SFTP ⁸ , MQTT ⁸ , LLDP ⁸ IPv4 : TCP/IP, UDP/IP, HTTP, HTTPS, RTSP, RTP, RTP/RTCP, SMTP, DHCP, DNS, DDNS, NTP, SNMP, UPnP, IGMP, ICMP, ARP, IEEE 802.1X, DiffServ, SSL/TLS ⁸ , SRTP ⁸ , SFTP ⁸ , MQTT ⁸ , LLDP ⁸
	Maximum concurrent access number	Up to 14 users (Depends on network conditions)
	SDXC/SDHC/SD Memory Card	H.265 / H.264 recording : Manual REC / Alarm REC (Pre/Post) / Schedule REC JPEG recording : Manual REC / Alarm REC (Pre/Post) Compatible SDXC/SDHC/SD card : Panasonic 2 GB, 4 GB ⁷ , 8 GB ⁷ , 16 GB ⁷ , 32 GB ⁷ , 64 GB ⁷ , 128 GB ⁷ , 256 GB ⁷ model *SDHC card, ** SDXC card (except miniSD card and microSD card)
	Mobile Terminal Compatibility	iPad, iPhone, Android™ terminals
	ONVIF Profile	G / S / T
	Alarm Source	3 terminals input, VMD, Command alarm
	Alarm Actions	SDXC/SDHC/SD memory recording, E-mail notification, HTTP alarm notification, Indication on browser, Panasonic alarm protocol output
	Input/ Output	Monitor output (for adjustment)
Audio Input For microphone		ø3.5 mm stereo mini jack, Recommended applicable microphone : Plug-in power type (Sensitivity of microphone : -48 dB ±3 dB (0 dB=1 V / Pa, 1 kHz)) Input impedance : Approx. 2 kΩ (unbalanced) Supply voltage : 2.5 V ±0.5 V
For line		Input level : Approx. -10 dBV
Audio Output ⁷	ø3.5 mm stereo mini jack (monaural output) Output impedance : Approx. 600 Ω (unbalanced) Output level : -20 dBV	
External I/O Terminals	ALARM IN1 (Alarm input 1/ Black & white input/ Auto time adjustment input) (x1) ALARM IN2 (Alarm input 2/ ALARM OUT) (x1), ALARM IN3 (Alarm input 3/ AUX OUT) (x1)	
General	Safety	UL (UL60950-1), c-UL (CSA C22.2 No.60950-1), CE, IEC60950-1
	EMC	FCC (Part15 ClassA), ICES003 ClassA, EN55032 ClassB, EN55024, EN55035 ECE-R10, EN50498 compliant, EN50121
	Power Source and Power Consumption	DC power supply : DC 12 V 1.04A/Approx. 12.5 W PoE (IEEE802.3af compliant) Device : DC 48 V 260 mA/Approx. 12.5 W (Class 0 device)
	Ambient Operating Temperature	IR LED : On -40 °C to +50 °C (-40 °F to 122 °F) IR LED : Off -40 °C to +60 °C (-40 °F to 140 °F)
	Ambient Operating Humidity	10% to 100 % (no condensation)
	Dehumidification Device	Rosahl element
	Water and Dust Resistance	IP66(IEC60529), Type 4X(UL50), NEMA 4X compliant
	Shock Resistance	50J (IEC 60068-2-75 compliant), IK10 (IEC 62262)
	Wind Resistance	Up to 40 m/s (approx. 89 mph)
	Railway Application	EN50155-TX
	Dimensions	When using the attachment plate only : ø154 mm × 60.3 mm (H) {ø6-1/16 inches × 2-3/8 inches (H)} Dome radius 35 mm {1-3/8 inches} When using the base bracket : ø164 mm × 96.3 mm (H) {ø6-15/32 inches × 3-25/32 inches (H)} Dome radius 35 mm {1-3/8 inches}
	Mass (approx.)	When using the attachment plate only : Approx. 880 g (1.94 lbs) When using the base bracket : Approx. 1.3 kg (2.87 lbs)
	Finish	Main body : Aluminum die cast, i-PRO white Outer fixing screws : Stainless steel (Corrosion-resistant treatment) Dome section : Polycarbonate resin, Clear

*1 Converted value
*2 When "On (level 30 or 31)" is selected for "Wide Dynamic Range(WDR)", the frame rate is restricted to a maximum of 15fps (30fps mode) or 12.5fps (25fps mode).
*3 Auto IQS, i-VMD, can not be used at the same time.
*4 When "Single PTZ" mode is used in wall installations, the 2560x1920 resolution cannot be used.
*5 Transmission for 2 streams can be individually set.
*6 When recording audio on an SD memory card, only use AAC-LC (Advanced Audio Coding - Low Complexity).
*7 The audio output can be switched to the monitor output.
Refer to the Operating Instructions on the our support web site for descriptions of how to switch the output.
*8 It may be necessary to upgrade the firmware to use these protocols

Appearance

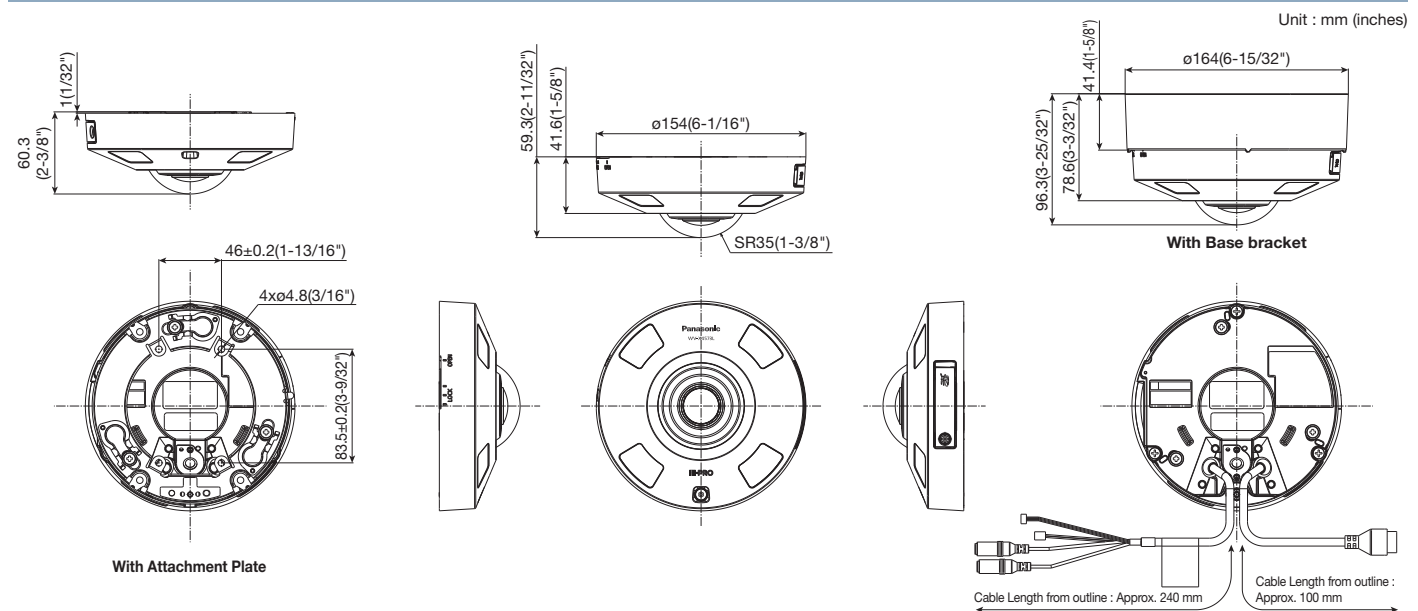

Bundled License

Plug-in Software for i-VMD

i-VMD is possible to detect objects in the specified area by advanced video analysis technology.
 i-VMD : People Counting, Heat-map, MOR (Moving Object Remover), Intruder Detection,
 Loitering Detection, Cross line Detection, Object Detection, Scene change Detection

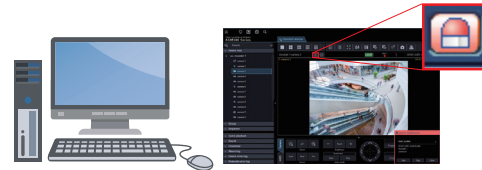

Notification sent to the monitoring screen

Optional Accessories

Fiber Optic Media Converter Unit

Extension Unit
WV-S25F1
 (Light gray)



Fiber Optic Media Converter Unit supports long distance optical networks by converting copper RJ45 to fiber.

• Basic specifications

Power source	24 V AC(50 Hz/60 Hz)
Ambient Operating Temperature :	-40 °C to +60 °C(-40 °F to 140 °F) (Power On range: -30 to +60 (-22 °F to 140 °F))
Ambient Operating Humidity :	10 % to 100 %(no condensation)
Waterproof	IP66(IEC60529)
Shock resistance	IK10(IEC62262)









*Refer to website for compatible SFP modules. <https://security.panasonic.com/support/info/> <Control No. : C0504>

• Support specifications for SFP module

SFP Port Type	LC type
Ethernet Speed	100/1000 Mbps
Supply voltage, current	3.3 V typical, Max. 300 mA
SFP Cage	Standard mini-SFP cage (For 6.5 mm pitch SFP)

*Different Color Model WV-X65F1 (Fine silver)

Mount Bracket / Other

<p>Ceiling Mount Bracket WV-Q105A</p>  <p>*For indoor installation only</p>	<p>Ceiling Mount Bracket WV-QCL501-W (i-PRO white)</p>  <p>(This bracket requires WV-QSR501-W.)</p>	<p>Wall Mount Bracket WV-QWL501-W (i-PRO white)</p>  <p>(This bracket requires WV-QSR501-W.)</p>	<p>Mount Bracket WV-QSR501-W (i-PRO white)</p>  <p>(This bracket requires WV-QCL501-W or WV-QWL501-W.)</p>	<p>Wall Mount Bracket WV-QWL500-W (i-PRO white)</p> 	<p>Adapter Box WV-QJB500-W (i-PRO white)</p>  <p>(This bracket requires WV-QWL501-W or WV-QWL500-W.)</p>
<p>Pole Mount Bracket WV-QPL500-W (i-PRO white)</p>  <p>(This bracket requires WV-QWL501-W or WV-QWL500-W.)</p>	<p>Corner Mount Bracket WV-QCN500-W (i-PRO white)</p>  <p>(This bracket requires WV-QWL501-W or WV-QWL500-W.)</p>				

• Brackets are available in four colors, Fine silver, Light gray, Gray and i-PRO white. It is possible to use them in different color combinations.

Important

- Safety Precautions : Carefully read the Basic Information, Installation Guide and Operating Instructions before using this product.
- Panasonic cannot be held responsible for the performance of the network and/or other manufacturers' products used on the network.

Trademarks and registered trademarks

- iPad and iPhone are trademarks of Apple Inc., registered in the U.S. and other countries.
- Android is a trademark of Google LLC.
- ONVIF is trademarks or registered trademarks of Onvif Inc.
- All other trademarks identified herein are the property of their respective owners.

• Masses and dimensions are approximate. • Specifications are subject to change without notice.

Panasonic®

Panasonic Corporation

Panasonic i-PRO Sensing Solutions Co., Ltd.

<https://ipro.panasonic.com>

<https://security.panasonic.com>

<https://www.linkedin.com/company/i-pro-sensing-solutions-co-ltd/>