

## 12MP Sensor Indoor 360-degree Fisheye Network Camera

The WV-X4173 captures the highest quality images in even very challenging and dynamic environments. In particular, the image of the person's face or object at the edge of the fisheye is clear with less distortion. Intelligent Auto (iA) monitors scene dynamics and motion to adjust key camera settings automatically in real-time reducing distortion such as motion blur on moving objects. Adopting H.265 Smart Coding technology, bandwidth efficiency is intelligently increased for longer recording and less storage. Cameras out-of-the-box, use an encryption module standardized by FIPS Publication 140-2 for secure video streaming.

### Extreme image quality for evidence capturing under challenging conditions

- Clear and less distorted image of the person's face and objects at the edge of the fisheye
- Instant response to sudden light changes like tunnel entry and exit
- Auto Shutter speed control for fast moving objects

### Extreme bandwidth compression with new H.265 Smart Coding

- Longer recording and less storage space compared to any H.264 based compression techniques
- New self-learning ROI\* encoding (Auto VIQS) dynamically detects motion areas to keep vehicles and humans in good picture quality while lowering your bandwidth \*Region of Interest

### Extreme Data Security

- Full encryption SD card edge recording to keep your data safe
- FIPS140-2 CAVP compliant \*Using encryption module standardized by FIPS publication 140-2
- Full end-to-end system encryption with supported VMS and devices to protect from IP snooping/spoofing and detect data alteration

### Complete with powerful analytics built-in

- Heat map : Visualization of people's traffic pattern and staying times
- People Counting : Statistics data on the number of people entering and leaving a specific zone
- MOR (Moving Object Remover) : Monitoring of only the surrounding environment by removing people and other moving objects from video

### Key Features

- 12MP Sensor
  - 2992x2992 pixel fisheye image up to 30fps
  - iA (intelligent Auto)
  - H.265 Smart Coding
  - i-VMD License Bundled
  - ONVIF® Profile G / S / T
- \*ONVIF is a trademark of ONVIF, Inc.

### Industry examples

- Transportation (Airport / Subway station)
- Logistics / Factory
- Education / Hospital
- Retail / Bank
- Building

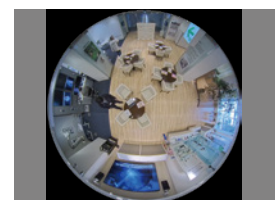

2992 x 2992  
4000 x 3000

# Specifications

<b>Camera</b>	Image Sensor	Approx. 1/2 type 12MP CMOS image sensor
	Minimum Illumination	Color : 0.3 lx, BW : 0.2 lx (F1.9, Maximum shutter : Off (1/30 s), AGC : 11) Color : 0.02 lx, BW : 0.01 lx (F1.9, Maximum shutter : max. 16/30s, AGC : 11) *1
	Intelligent Auto	On / Off
	Maximum shutter	Max.16/30s to Max. 1/10000s
	Wide Dynamic Range <sup>2</sup>	On / Off, The level can be set in the range of 0 to 31.
	Dynamic Range	Max.84 dB (Wide Dynamic Range : On, Level: 31)
	Image Settings	Gain (AGC), White balance
	Image Compensation	Adaptive black stretch, Back light compensation (BLC), Fog compensation, High light compensation (HLC), Digital noise reduction
	Day / Night (Electrical)	Off / Auto
	Video Motion Detection (VMD)	On / Off, 4 areas available
	Intelligent VMD (i-VMD) <sup>3</sup>	Type 8 *Bundled License
	<b>Lens</b>	Privacy Zone
Camera Title (OSD)		On / Off, Up to 20 characters (alphanumeric characters, marks)
Fixing angle adjustment		-5°, 0°, +5°
Zoom Ratio		1x
Digital (electronic) zoom		Choose from 3 levels of x1, x2, x4
<b>DORI</b>	Focal length	1.4 mm (1/16 inches)
	Maximum Aperture Ratio	1 : 1.9
	Focus range	0.5 m (19-11/16 inches) - ∞
	Angular Field of view	Horizontal : 183° Vertical : 183°
	Distance to the object in the center of the image	Detect (25 ppm / 8 ppf) : 29.9 m / 98.2 ft Observe (62.5 ppm / 19 ppf) : 12.0 m / 39.3 ft Recognize (125 ppm / 38 ppf) : 6.0 m / 19.6 ft Identify (250 ppm / 76 ppf) : 3.0 m / 9.8 ft
<b>Browser GUI</b>	Coverage radius when mounted at a height of 3 m (10 ft)	Detect (25 ppm / 8 ppf) : 56.1 m/184.2 ft Observe (62.5 ppm / 19 ppf) : 20.6 m / 67.6 ft Recognize (125 ppm / 38 ppf) : 8.4 m / 27.6 ft Identify (250 ppm / 76 ppf) : 0.3 m / 0.9 ft
	Camera Control	Brightness, AUX On / Off
<b>Network</b>	Audio	Mic (Line) Input : On / Off Volume adjustment : Low / Middle / High Audio Output : On / Off Volume adjustment : Low / Middle / High
	GUI / Setup Menu Language	English, Italian, French, German, Spanish, Portuguese, Russian, Chinese, Japanese
<b>Network</b>	Network IF	10Base-T / 100Base-TX, RJ45 connector
	Resolution	<Ceiling> • <b>Fisheye mode (max. 30 fps/25 fps)</b> 2992×2992 / 2192×2192 / 1280×1280 / 640×640 / 320×320 • <b>Quad PTZ mode (max. 15 fps/12.5 fps)</b> , <b>Single PTZ mode (max. 15 fps/12.5 fps)</b> 2560×1920 <sup>4</sup> / 2048×1536 / 1600×1200 / 1280×960 / 800×600 / VGA / QVGA <Ceiling> • <b>Double Panorama mode (max. 15 fps/12.5 fps)</b> 2560×1440 / 1920×1080 / 1280×720 / 640×360 / 320×180 • <b>Fisheye + Double Panorama mode (max. 15 fps/12.5 fps)</b> (Fisheye) 2992×2992 / 2192×2192 / 1280×1280 / 640×640 / 320×320 (Double Panorama) 1280×720 / 640×360 / 320×180 • <b>Fisheye + Quad PTZ mode (max. 15 fps/12.5 fps)</b> (Fisheye) 2992×2992 / 2192×2192 / 1280×1280 / 640×640 / 320×320 (Quad PTZ) 1280×960 / 800×600 / VGA / QVGA • <b>Quad streams mode</b> (Single PTZ (Quad streams)) 1280×960 / 800×600 / VGA / QVGA (max. 15 fps/12.5 fps) (Quad PTZ) 2560×1920 / 2048×1536 / 1600×1200 / 1280×960 / 800×600 / VGA / QVGA (max. 5 fps) <Wall> • <b>Panorama mode (max. 15 fps/12.5 fps)</b> 2560×1440 / 1920×1080 / 1280×720 / 640×360 / 320×180 • <b>Fisheye + Panorama mode (max. 15 fps/12.5 fps)</b> (Fisheye) 2992×2992 / 2192×2192 / 1280×1280 / 640×640 / 320×320 (Panorama) 1280×720 / 640×360 / 320×180

<b>Network</b>	H.265/ H.264 <sup>5</sup>	Transmission Mode	Constant bit rate / VBR / Frame rate / Best effort
	JPEG	Transmission Type	Unicast port (AUTO)/ Unicast port (MANUAL)/ Multicast
	Smart Coding	Image Quality	10 steps
	Audio Compression	GOP (Group of pictures) control :	On (Frame rate control) / On (Advanced)* / On (Mid) / On (Low) / Off *On (Frame rate control) and On (Advanced) are only available with H.265.
	Supported Protocol	Auto VIOS : On / Off	
		G.726 (ADPCM) : 16 kbps / 32 kbps G.711 : 64 kbps AAC-LC <sup>6</sup> : 64 kbps / 96 kbps / 128 kbps	
	Maximum concurrent access number	IPV6 : TCP/IP, UDP/IP, HTTP, HTTPS, SMTP, DNS, NTP, SNMP, DHCPv6, RTP, MLD, ICMP, ARP, IEEE 802.1X, DiffServ, SSL/TLS <sup>7</sup> , SRTP <sup>7</sup> , SFTP <sup>7</sup> , MQTT <sup>7</sup> , LLDP <sup>7</sup>	
		IPV4 : TCP/IP, UDP/IP, HTTP, HTTPS, RTSP, RTP, RTSP/RTCP, SMTP, DHCP, DNS, DDNS, NTP, SNMP, UPnP, IGMP, ICMP, ARP, IEEE 802.1X, DiffServ, SSL/TLS <sup>7</sup> , SRTP <sup>7</sup> , SFTP <sup>7</sup> , MQTT <sup>7</sup> , LLDP <sup>7</sup>	
	Memory Card	Up to 14 users (Depends on network conditions)	
		H.265 / H.264 recording : Manual REC / Alarm REC (Pre/Post) / Schedule REC JPEG recording : Manual REC / Alarm REC (Pre/Post) Compatible SDXC/SDHC/SD card : Panasonic 2 GB, 4 GB*, 8 GB*, 16 GB*, 32 GB*, 64 GB**, 128 GB**, 256 GB** model *SDHC card, **SDXC card (except miniSD card and microSD card)	
Mobile Terminal Compatibility	iPad, iPhone, Android™ terminals		
<b>Alarm</b>	ONVIF <sup>8</sup> Profile	G / S / T	
	Alarm Source	3 terminals input, VMD, Command alarm	
	Alarm Actions	SDXC/SDHC/SD memory recording, E-mail notification, HTTP alarm notification, Indication on browser, TCP alarm notification output	
<b>Input/Output</b>	Monitor output (for adjustment)	VBS : 1.0 V [p-p] / 75 Ω, composite, ø3.5 mm mini jack An NTSC or PAL signal can be outputted from camera	
	Audio Input For microphone	ø3.5 mm stereo mini jack, Recommended applicable microphone : Plug-in power type (Sensitivity of microphone : -48 dB ±3 dB (0 dB=1 V / Pa, 1 kHz)) Input impedance : Approx. 2 kΩ (unbalanced) Supply voltage : 2.5 V ±0.5 V	
	For line	Input level : Approx. -10 dBV	
	Built-in microphone	Nondirectional electret condenser microphone	
	Audio Output <sup>8</sup>	ø3.5 mm stereo mini jack (monaural output) Output impedance : Approx. 600 Ω (unbalanced) Output level : -20 dBV	
<b>General</b>	External I/O Terminals	ALARM IN1 (Alarm input 1/ Auto time adjustment input) (x1) ALARM IN2 (Alarm input 2/ ALARM OUT) (x1) ALARM IN3 (Alarm input 3/ AUX OUT) (x1)	
	Safety	UL (UL60950-1), c-UL (CSA C22.2 No.60950-1), CE, IEC60950-1	
<b>General</b>	EMC	FCC (Part15 ClassA), ICES003 ClassA, EN55032 ClassB, EN55024, EN55035	
	Power Source and Power Consumption	DC power supply : DC 12 V 560 mA/Approx. 6.7 W PoE (IEEE802.3af compliant) Device : DC 48 V 150 mA/Approx. 7.2 W (Class 0 device)	
	Ambient Operating Temperature	-10 °C to +50 °C (14 °F to 122 °F)	
	Ambient Operating Humidity	10% to 90 % (no condensation)	
	Dimensions	ø150 mm × 49.5 mm (H) (ø5-29/32 inches × 1-15/16 inches (H))	
Mass (approx.)	Approx. 420 g (0.93 lbs)		
Finish	Main body : ABS resin, i-PRO white		

\*1 Converted value  
 \*2 When "On (level 30 or 31)" is selected for "Wide Dynamic Range(WDR)", the frame rate is restricted to a maximum of 15fps (30fps mode) or 12.5fps (25fps mode).  
 \*3 Auto VIOS, i-VMD, can not be used at the same time.  
 \*4 When "Single PTZ" mode is used in wall installations, the 2560×1920 resolution cannot be used.  
 \*5 Transmission for 2 streams can be individually set.  
 \*6 When recording audio on an SD memory card, only use AAC-LC (Advanced Audio Coding - Low Complexity).  
 \*7 It may be necessary to upgrade the firmware to use these protocols  
 \*8 The audio output can be switched to the monitor output.  
 Refer to the Operating Instructions on the our support web site for descriptions of how to switch the output.

# Appearance

Unit : mm (inches)

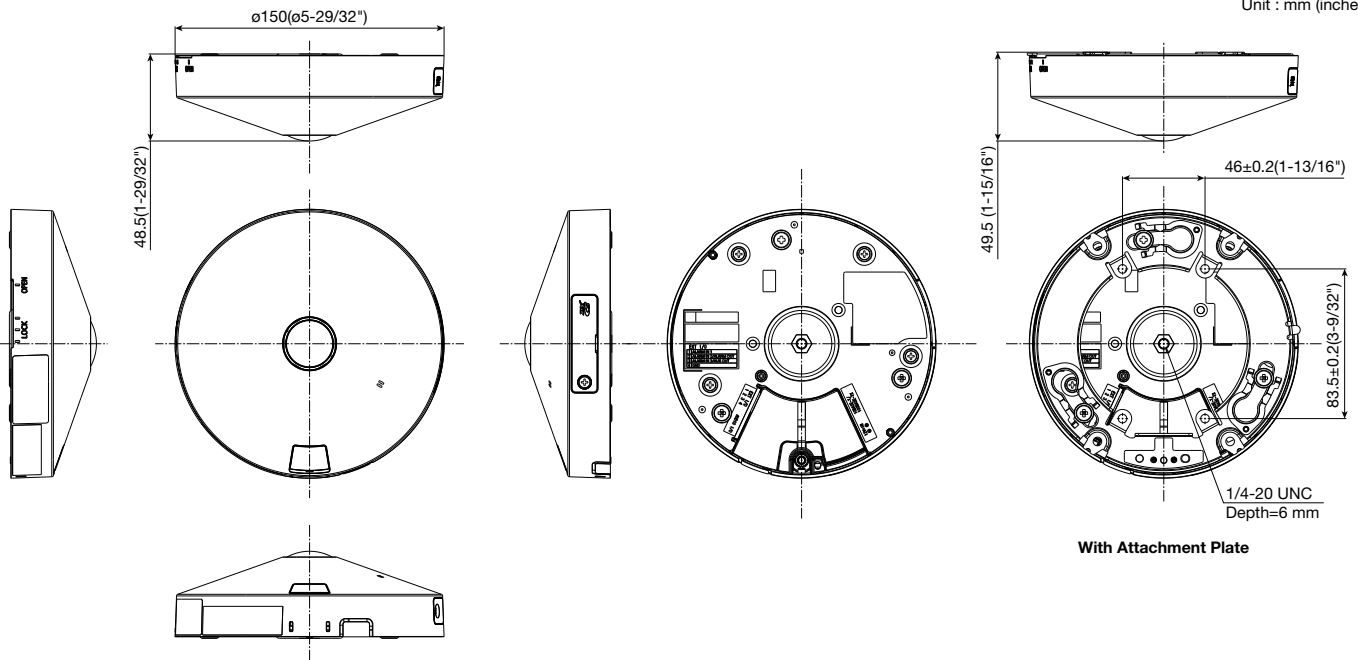

## Bundled License

### Plug-in Software for i-VMD



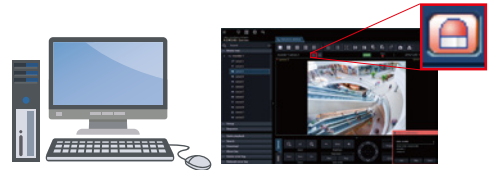

i-VMD is possible to detect objects in the specified area by advanced video analysis technology.  
 i-VMD : People Counting, Heat-map, MOR (Moving Object Remover), Intruder Detection, Loitering Detection, Cross line Detection, Object Detection, Scene change Detection



Notification sent to the monitoring screen

## Optional Accessories

### Mount Bracket / Other

<p>Ceiling Mount Bracket <b>WV-Q105A</b></p> 	<p>Wall Mount Bracket <b>WV-QWL500-W</b> (i-PRO white)</p> 	<p>Adapter Box <b>WV-QJB500-W</b> (i-PRO white)</p>  <p>(This bracket requires WV-QWL500-W.)</p>	<p>Pole Mount Bracket <b>WV-QPL500-W</b> (i-PRO white)</p>  <p>(This bracket requires WV-QWL500-W.)</p>	<p>Corner Mount Bracket <b>WV-QCN500-W</b> (i-PRO white)</p>  <p>(This bracket requires WV-QWL500-W.)</p>
------------------------------------------------------------------------------------------------------------------------------------	------------------------------------------------------------------------------------------------------------------------------------------------------	-------------------------------------------------------------------------------------------------------------------------------------------------------------------------------------------	---------------------------------------------------------------------------------------------------------------------------------------------------------------------------------------------------	------------------------------------------------------------------------------------------------------------------------------------------------------------------------------------------------------

• Brackets are available in four colors, Fine silver, Light gray, Gray and i-PRO white. It is possible to use them in different color combinations.

#### Trademarks and registered trademarks

- iPad and iPhone are trademarks of Apple Inc., registered in the U.S. and other countries.
- Android is a trademark of Google LLC.
- ONVIF is a trademark of ONVIF, Inc.
- All other trademarks identified herein are the property of their respective owners.

#### Important

- Safety Precautions : Carefully read the Basic Information, Installation Guide and Operating Instructions before using this product.
- i-PRO Co., Ltd. cannot be held responsible for the performance of the network and/or other manufacturers' products used on the network.

• Masses and dimensions are approximate. • Specifications are subject to change without notice.