

User Manual

HD Visual Communication Unit

Model No. KX-VC1000/KX-VC1300/KX-VC1600/KX-VC2000
KX-VC1000SX/KX-VC1300SX/KX-VC1600SX/KX-VC2000SX
KX-VC1300A/KX-VC1600A



Thank you for purchasing this Panasonic product.

Please read this manual carefully before using this product and save this manual for future use.

KX-VC1000/KX-VC1300/KX-VC1600/KX-VC2000: Software File Version 5.00 or later

In this manual, the suffix of each model number (e.g., KX-VCA001XX) is omitted unless necessary.

In this manual, HD Visual Communication is abbreviated as "HDVC".

Introduction

Feature Highlights

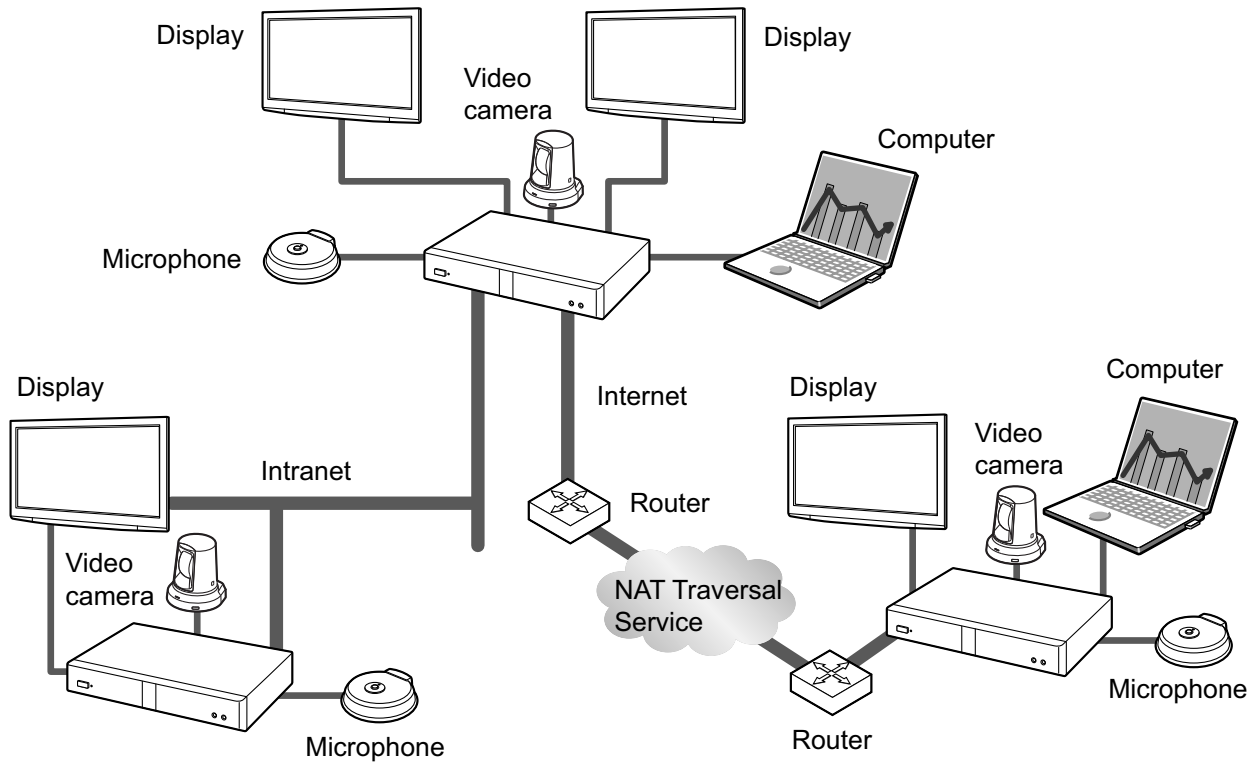

Lifelike Video Conference Call

You can experience lifelike video conference calls with smooth, high-quality video and clear stereo^{*1} sound.

^{*1} If using 2 or more Digital Boundary Microphones, stereo output can be enabled through system settings (Page 128). When using Digital Boundary Microphones and an Analogue Boundary Microphone together, stereo output may be unavailable depending on the connection configuration (Page 31, Page 33).

Home Electronics-style Remote Control Operation and Simple, Easy to Understand Graphical User Interface

You can make settings and perform operations using familiar remote control operations and a simple, easy to understand interface.

Stabilised Communication Quality

In periods of network congestion, automatic packet transmission rate quality control prevents packet loss to maintain a video conference call's image and sound quality. This allows video conference calls with stabilised communication quality even over an Internet connection or mobile communication.

Dual stream (2 screens) compatible

You can send the image of your video camera and the image of your computer's screen or a sub video camera at the same time to the other party.

You can view the other party and check shared data at the same time to hold more realistic and interactive meetings.

Dual network compatibility (KX-VC1600/KX-VC2000)

You can connect to different networks at the same time, such as your company's internal network and the Internet. This allows seamless connectivity with units both inside and outside of your company.

Multi-party connections

The KX-VC1000 can establish connections with 2 parties standard, and is expandable to establish multiple connections with a maximum of 4 parties. The KX-VC1300 can establish multiple connections with a maximum of 4 parties. The KX-VC1600 can establish multiple connections with a maximum of 6 parties standard, and is expandable to a maximum of 10 parties. The KX-VC2000 can establish multiple connections with a maximum of 16 parties standard, and is expandable to a maximum of 20 or 24 parties. All devices have MCU functions built-in, allowing for flexible connectivity.

Note

- In this manual, 1 unit with a built-in MCU which connects to multiple sites simultaneously is referred as to the "Main Site", and the sites connecting to the Main Site are referred to as "Sub Sites". A site that establishes connections to multiple sites using a Profile Call (Page 54), or a site that adds a site to the call during a 2-party video conference call with another site (Page 67) becomes the "Main Site".

Selectable Video Source

By connecting your computer or video camera to the unit, you can show your computer's screen or video camera image to video conference call participants (Page 89).

Encrypted Communication

Packets sent for video conference calls can be encrypted to prevent packet leaks, tampering, or eavesdropping.

KX-VC Series NAT Traversal Service

"KX-VC Series NAT Traversal Service" is a service that allows you to easily and affordably set up and operate a communication environment for the HD Visual Communication Unit.¹⁾²⁾³⁾ Also, complicated router configuration is unnecessary, which allows even people who are not network administrators set up a communication environment. Furthermore, you can assign the unit a unique number (Terminal ID), which allows the unit to be called not by IP address, but with the unique 7-digit number. This means communication can be initiated as if calling a telephone. Communication can also be encrypted, so that you can communicate over the Internet safely and securely.

For details about KX-VC Series NAT Traversal Service, refer to the following web site:

https://panasonic.net/cns/psn/products/hdvc/nat/nat_traversal/index.html

^{*1} This service may be unavailable depending on the country/area of use. For details, contact your dealer.

^{*2} This service may be unavailable depending on your router's type or your Internet connection environment. For details, contact your dealer.

^{*3} IPv6 addresses cannot be used.

Making Video Conference Calls via SIP Server

By using a SIP server, you can establish video conference calls not just by IP address, but also by specifying a SIP URI (SIP user name@SIP domain name) instead. If the other party uses the same SIP domain name as you, you can make a video conference call by specifying only the SIP user name. For information about supported SIP servers, contact your dealer.

Calling via an H.323 Gatekeeper

Going through an H.323 Gatekeeper allows communication of not just the IP address, by the H.323 extension and the H.323 name as well. Contact your dealer regarding the gatekeepers that can be used.

Enhanced Features through the Use of Activation Keys

By using an activation key (sold separately), you can upgrade the features of the unit (Page 20). This allows enrollment in the KX-VC Series NAT Traversal Service, and enables Mobile Connection, Multicast, and USB Device Mode features.

If using the KX-VC2000, multiple connections can be made with up to 20 or 24 parties simultaneously. If using the KX-VC1600, multiple connections can be made with up to 10 parties simultaneously. The KX-VC1000 can establish connections with a maximum of 4 parties and also supports dual monitors.

Remote Video Camera Operation via Remote Control

You can move your own video camera up, down, left, and right as well as zoom in and out (Page 92). You can also register up to 9 preset patterns of video camera direction and zoom level which allows you to easily change the video camera's direction and zoom level by selecting a preset (Page 95, Page 97). Additionally, you can also use your remote control to control the other party's video camera.^{*1}

^{*1} To be able to control another party's video camera, settings must be configured on the other party's unit (Page 131).

IPv6 Address

Communication can be made using IPv6 addresses. IPv6 addresses can also be used for SIP Servers and H.323 Gatekeepers.

USB Recording

You can record video and audio of conferences and save them on a USB memory device that is connected to the USB jack on the back of the unit (Page 82, Page 132, Page 183).

Trademarks

- The terms HDMI and HDMI High-Definition Multimedia Interface, and the HDMI Logo are trademarks or registered trademarks of HDMI Licensing Administrator, Inc. in the United States and other countries.
- Polycom® is a trademark owned by Polycom, Inc. in the US and other countries.
- Microsoft, Encarta, MSN, and Windows are either registered trademarks or trademarks of Microsoft Corporation in the United States and/or other countries.
- Mozilla and Firefox are registered trademarks of the Mozilla Foundation.
- QuickTime is a trademark of Apple Inc., registered in the U.S. and other countries.
- All other trademarks identified herein are the property of their respective owners.

Licences

- THIS PRODUCT IS LICENSED UNDER THE AVC PATENT PORTFOLIO LICENSE FOR THE PERSONAL USE OF A CONSUMER OR OTHER USES IN WHICH IT DOES NOT RECEIVE REMUNERATION TO (i) ENCODE VIDEO IN COMPLIANCE WITH THE AVC STANDARD (“AVC VIDEO”) AND/OR (ii) DECODE AVC VIDEO THAT WAS ENCODED BY A CONSUMER ENGAGED IN A PERSONAL ACTIVITY AND/OR WAS OBTAINED FROM A VIDEO PROVIDER LICENSED TO PROVIDE AVC VIDEO. NO LICENSE IS GRANTED OR SHALL BE IMPLIED FOR ANY OTHER USE. ADDITIONAL INFORMATION MAY BE OBTAINED FROM MPEG LA, L.L.C. SEE [HTTP://WWW.MPEGLA.COM](http://www.mpegla.com)
- This product incorporates G.722.1 and G.722.1 Annex C licensed by Polycom®.
- This product incorporates Qt library licenced by Digia Plc. Please read **"EULA"** of system settings of this product.

Open Source Software

Parts of this product use Open Source Software supplied based on the conditions of the Free Software Foundation's GPLs and/or LGPLs, and the conditions of the ITU-T and other conditions. Relevant conditions apply to this software. Therefore, please read license information about GPLs, LGPLs, and ITU-T, and **"License Info."** of system settings of this product before using this product. Also, some software parts of this product are licensed under the MOZILLA PUBLIC LICENSE (MPL). At least three (3) years from delivery of products, Panasonic will give to any third party who contacts us at the contact information provided below, for a charge of no more than the cost of physically distributing source code, a complete machine-readable copy of the corresponding source code and the copyright notices covered under GPL, LGPL, MPL, and ITU-T. Please note that software licensed under GPL, LGPL, MPL, and ITU-T is not under warranty.

Contact Information

http://www.panasonic.net/corporate/global_network/

Miscellaneous

About the Screen Shots and Illustrations in this Manual

The screen shots and descriptions in this manual are based on using the KX-VC2000 (when used with enhanced features). However, some of the screens shots are based on using the KX-VC1600. If you are using the KX-VC1000, KX-VC1300, KX-VC1600, or KX-VC2000 (without using the enhanced features), please note that some displayed features will not be available for your model. Also please note that the illustrations in this manual are based on using the KX-VC1600.

Copyright

- The software used in this product uses source code from Radvision Ltd. Portions of this software are © 1996-2012 RADVISION Ltd. All intellectual property rights in such portions of the Software and documentation are owned by RADVISION and are protected by United States copyright laws, other applicable copyright laws and international treaty provisions. RADVISION and its suppliers retain all rights not expressly granted.
- Except for open source software licensed under GPL/LGPL and so on, distributing, copying, disassembling, reverse compiling and reverse engineering of the software provided with this product are all expressly prohibited. In addition, exporting any software provided with this product violating export laws is prohibited.

Table of Contents

For Your Safety	11
For Your Safety	11
Before Operation	13
Notes about Operation	13
Data Security	14
Privacy and Right of Publicity	14
Precaution	15
Precaution	15
Preparation	17
Accessory/Optional Accessory Information	17
Optional Accessory	18
Part Names and Usage	22
Main Unit (Front)	22
Main Unit (Back)	23
Remote Control	25
LED Indication	27
Screen Standby	27
Connection and Preparation	29
Device and Network Connection	29
Connecting the Unit	30
Network Configuration Example	37
Preparing the Remote Control	39
Turning the Power On/Off	40
Screen Display	41
Home Screen (Idle Screen)	41
Menu Screen (Idle Screen)	44
Video Conference Call Screen	45
Entering characters	47
About IPv6 Addresses	47
Initial Settings	48
Starting a Video Conference	51
Making a Video Conference Call	51
Calling Using One-Touch Connection Numbers From the Home Screen	51
Calling from the Contact List (2-party Conference)	52
Calling Using Profile (Multiple-party Video Conference Calls)	54
Calling by Entering an Address Directly	56
Calling from the Call History	59
Answering a Video Conference Call	63
Connecting to an MCU	65
During Video Conference Calls	67
Adding Parties to an Existing Video Conference Call (Except Sub Sites)	67
Disconnecting Parties During Video Conference Call	69
Changing the Contents Sharing Method During Communication	70
Changing the Screen Layout during a Video Conference Call	71
Changing the Other Party's Screen Display Layout	72
Changing the MCU Mode (Main Site Only)	77
Changing the Setting of the Main Display (Main Site only)	78

Changing the Site Name Display (Main Site only)	80
Changing the Audio Settings for Other Parties (Main Site only)	81
Changing the Settings for Audio Mixing Sites (Main Site Only)	82
Starting and Stopping Recording	82
Checking the Call History	84
Adjusting the Volume	85
Muting the Microphone	86
Reducing Microphone Noise	88
Displaying a Computer's Screen and the Sub Video Camera's Image	89
Controlling a Video Camera	92
Controlling a Video Camera	92
Registering a Preset	95
Recalling a Registered Preset	97
Changing Video Camera Settings	98
Displaying the Connection Status	103
Displaying the Connection Status	103
Displaying Unit Information	104
Contacts and Settings	105
Adding Contacts to the Contact List	105
Registering a New Contact	105
Editing Contact Information	106
Deleting a Contact	106
Registering a Contact from the Call History	107
Registering a Profile	108
Registering a New Profile	108
Editing Profile Information	111
Deleting a Profile	111
Setting the Profile Standby	112
Removing a Profile Standby	112
Making Local Site Settings	113
Registering a Local Site	113
Selecting a Local Site	113
Deleting Local Site Information	114
Changing System Settings/Performing System Maintenance	115
Setting the Unit Name	118
Setting the Date and Time	118
Making Network Settings	118
Making Connection Settings	121
Setting the MCU	124
Setting One-touch Connection Numbers	127
Making Screen Standby Settings	127
Making Sound Settings	127
Setting the MIC Position	128
Making Remote Control Settings	130
Changing Video Camera Settings	131
Making Language Settings	131
Making Recording Settings	132
Using Multicast	132
Setting the USB Device Mode	132
Display Unit Information	133
Checking Enhanced Features	133
Performing a Network Test	134

Performing Self Diagnosis	134
Displaying the Licence Information	135
Displaying the End-User Licence Agreement	135
Performing Remote Maintenance	135
Making Administrator Menu Settings	136
Administrator Menu List	136
Making Administrator Password Settings	140
Making Encryption Settings	140
Making Software Update Settings	141
Making Connection Mode Settings	142
Making NAT Settings	142
Making Call Type Settings	143
Making SIP Settings	144
Making H.323 Settings	145
Making Codec Settings	147
Making Security Settings	147
Making Video Output Settings	150
Making Audio Input/Output Settings	152
Making GUI Settings	153
Making HDMI Settings	154
Setting Power Management	154
Setting Shortcuts	155
Setting Local Site Selection	156
Setting Multicast Tree	156
Exporting Data	156
Importing Data	157
Activating Enhanced Features	158
Updating Software	159
Initialising a Video Camera	160
Performing System Initialisation	160
Setting Remote Access	161
Using the KX-VC Series NAT Traversal Service	163
Using the KX-VC Series NAT Traversal Service	163
Preparations for Connections	163
KX-VC Series NAT Traversal Service Setup Procedure	163
Connect to the Internet	165
Obtain a Registration Key	165
To check the MPR ID (using the unit)	165
To obtain a Registration Key (using a computer)	166
To display the Registration Key again (using a computer)	167
Using Mobile Connection Enhanced Features	171
Using Mobile Connection Enhanced Features	171
Using Multicast	172
Using Multicast	172
About Multicast	172
Multicast Operation	173
Starting Multicast	173
Ending the Multicast	173
Handling of Trouble During a Multicast	173
The Multicast Tree	174
About the Network	174
Setting the System	175

Setting Multicast	175
Making Administrator Menu Settings	175
Registering the Multicast Tree	175
Starting a Multicast	179
Starting a Multicast	179
Starting a Multicast by Selecting the Multicast Target	179
Confirming the Transmission Status During a Multicast (Multicast Terminal)	181
Confirming the Transmission Status During a Multicast (Relay Terminal/Receiver Terminal)	182
Starting and Stopping Recording During a Multicast	182
Using USB Recording Features	183
Using USB Recording Features	183
Using USB Device Mode	186
Using USB Device Mode	186
Miscellaneous	188
Changing the Remote Control Batteries	188
Cleaning the Unit	189
Input	190
Inputting Letters and Numbers	190
Additional Information	203
Troubleshooting	203
Basic Operation	203
Audio	209
System Settings	211
If These Messages Appear	211
Registration Page of KX-VC Series NAT Traversal Service	218
KX-VC Series NAT Traversal Service for this Device	219
If a message from the KX-VC Series NAT Traversal Service is displayed	220
Specifications	222
System Specifications	222
Index.....	225

For Your Safety

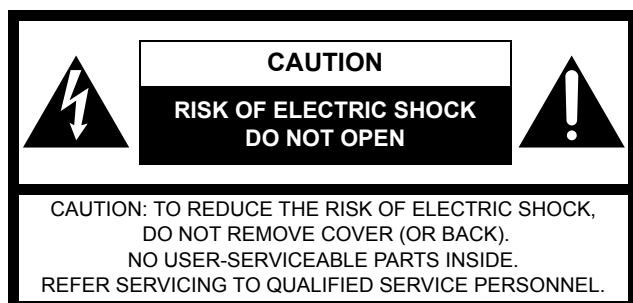

The lightning flash with arrowhead symbol, within an equilateral triangle, is intended to alert the user to the presence of uninsulated "dangerous voltage" within the product's enclosure that may be of sufficient magnitude to constitute a risk of electric shock to persons.



The exclamation point within an equilateral triangle is intended to alert the user to the presence of important operating and maintenance (servicing) instructions in the literature accompanying the appliance.

WARNING:

- The mains plug or an appliance coupler shall remain readily operable.
- To prevent fire or electric shock hazard, do not expose this apparatus to rain or moisture.
- The apparatus should not be exposed to dripping or splashing and no objects filled with liquids, such as vases, should be placed on the apparatus.
- All work related to the installation of this product should be made by qualified service personnel or system installers.
- The connections should comply with local electrical code.
- Batteries (battery pack or batteries installed) shall not be exposed to excessive heat such as sunshine, fire or the like.
- This is a class A product. In a domestic environment this product may cause radio interference in which case the user may be required to take adequate measures.
- This equipment is compliant with Class A of CISPR 32. In a residential environment this equipment may cause radio interference.
- Do not use your headset at a high volume. The use of excessive sound volume through a headset may cause hearing loss.

CAUTION:

- Before attempting to connect or operate this product, please read the label on the bottom.
- Be sure to use the specified type of batteries only.
- Ensure that batteries are installed with correct polarity. Incorrectly installed batteries can burst or leak, resulting in spillage or injuries.
- This product contains batteries. Replace only with the same or equivalent type. Improper use or replacement may cause overheating, rupture or explosion resulting in injury or fire. Dispose of used batteries according to the instructions of your local solid waste officials and local regulations.
- When replacing the batteries for the remote control, use R6 (AA) type dry cell.

For use only with power supply Panasonic, PGLV1006. (KX-VC1000/KX-VC1300/KX-VC1600/KX-VC1000SX/KX-VC1300SX/KX-VC1600SX)
 For use only with power supply Panasonic, PGLV1011. (KX-VC1300A/KX-VC1600A)
 For use only with power supply Panasonic, PGLV1017. (KX-VC2000/KX-VC2000SX)

UL listed model No.:
 KX-VC1300A/KX-VC1600A/
 KX-VC1000/KX-VC1300/KX-VC1600/KX-VC2000

Important Safety Instructions:

- 1) Read these instructions.
- 2) Keep these instructions.
- 3) Heed all warnings.
- 4) Follow all instructions.
- 5) Do not use this apparatus near water.
- 6) Clean only with dry cloth.
- 7) Do not block any ventilation openings. Install in accordance with the manufacturer's instructions.
- 8) Do not install near any heat sources such as radiators, heat registers, stoves, or other apparatus (including amplifiers) that produce heat.
- 9) Protect the power cord from being walked on or pinched particularly at plugs, convenience receptacles, and the point where they exit from the apparatus.
- 10) Only use attachments/accessories specified by the manufacturer.

For Your Safety

- 11) Unplug this apparatus during lightning storms or when unused for long periods of time.
- 12) Refer all servicing to qualified service personnel. Servicing is required when the apparatus has been damaged in any way, such as power-supply cord or plug is damaged, liquid has been spilled or objects have fallen into the apparatus, the apparatus has been exposed to rain or moisture, does not operate normally, or has been dropped.

Notes about Operation

Please pay attention to the following points when using this device:

1. **Please contact your dealer for installing, upgrading, or repairing this device.**
2. **Do not forcefully hit or shake this device.**
Dropping or bumping this device can damage or break this device.
3. **Do not place this device in a freezer or other location where it is exposed to cold temperatures.**
Doing so may result in damage or malfunctions.
4. **Place this device at least 2 m (6.5 ft) away from radios, office equipment, microwave ovens, air conditioning units, etc.**
Noise from electronic devices can cause static and interference in other devices.
5. **Do not place this device in a location where it is exposed to hydrogen sulfide, phosphorous, ammonia, sulfur, carbon, acid, dirt, toxic gas, etc.**
Doing so may result in damage, and the usable life-span of the device may decrease.
6. **Do not apply insecticides or other volatile liquids to the device, nor leave rubber bands or vinyl objects on the device for extended periods of time.**
Doing so may result in alterations to the material or paint peeling off the device.
7. **Do not bring cards with magnetic strips, such as credit cards and telephone cards, near the microphone.**
Cards might become unusable.
8. **Do not bring the device near items that emit electromagnetic waves or that are magnetised (high-frequency sewing machines, electric welders, magnets, etc.).**
Doing so may result in static noise or damage.
9. **Keep the device at least 10 cm (4 in) away from all walls.**
If placed against a wall, the device may not be able to ventilate properly, which may lead to a system malfunction due to overheating.

10. **Avoid placing the device in areas with high humidity, and exposing it to rain.**
Neither the main unit nor the power plug is water resistant.
11. **The power outlet should be near the product and easily accessible.**

About the Operating Environment

This device includes a feature that automatically adjusts voice transmissions to improve clarity. After beginning a video conference call, adjustments to the call environment may not complete immediately, and as a result voices may cut out or echo. In such cases, at the beginning of the video conference call, be sure to speak in turn with other parties.

About Moving the Device

Do not move this device while cords are still connected. Doing so may result in damage to the cords.

Other

- The unit may not operate in the event of a power failure.
- After unpacking the product, dispose of the power plug cap and packing materials appropriately.

Data Security

We recommend observing the security precautions described in this section, in order to prevent the disclosure of sensitive information.

Panasonic is not responsible for any damages caused by improper use of this device.

Preventing Data Loss

Keep a separate record of the encryption key and all information stored in the contact list.

Preventing Data Disclosure

- Do not place this device in a location that can be accessed or removed without authorisation.
- If important information is saved on this device, store it in an appropriate location.
- Do not store sensitive personal information in the unit.
- In the following situations, make a record of the encryption key and the information stored in the contact list and return the unit to the state it was in when purchased.
 - Before lending or disposing of the unit
 - Before handing the unit over to a third party
 - Before having the unit serviced
- Make sure the unit is serviced by only a certified technician.

This device can register and store personal data (the contact list, encryption key, connection history, etc.). In order to prevent the disclosure of data stored on this device, make sure to delete all data that is registered and stored on this device prior to disposing of, lending, or returning this device.

Preventing Data Disclosure over the Network

- To ensure the security of private conversations, only connect the unit to a secure network.
- To prevent unauthorised access, only connect the unit to a network that is properly managed.
- Make sure all computers connected to the unit employ up-to-date security measures.
- To prevent illegal access from the Internet, activate a Firewall.

Privacy and Right of Publicity

By installing and using this device, you are responsible for maintaining the privacy and usage rights of images and other data (including sound picked up by the microphone). Use this device accordingly.

- Privacy is generally said to be, "A legal guarantee and right not to have the details of one's personal life unreasonably publicised, and the right to be able to control information about oneself. In addition, right of publicity is a right not to have a likeness of one's face or figure photographed and publicised without consent".
- When Automatic Answer or Forced Answering is set as an answer method for incoming calls, transmission begins as soon as a video conference call is received (Page 121). The receiver of the video conference call will begin transmitting as soon as the video conference call is received at any time, from any caller. Please be aware when the Automatic Answer feature or Forced Answering feature is enabled, there is a risk that due to an unexpected, automatically answered video conference call, privacy rights may be violated or sensitive information may be transmitted to unauthorised parties.

Precaution

For users in the United Kingdom

FOR YOUR SAFETY, PLEASE READ THE FOLLOWING TEXT CAREFULLY.

This appliance is supplied with a moulded three-pin mains plug for your safety and convenience. Should the fuse need to be replaced, please ensure that the replacement fuse is of the same rating and that it is approved by ASTA or BSI to BS1362.

Check for the ASTA mark  or the BSI mark  on the body of the fuse.

If the plug contains a removable fuse cover, you must ensure that it is refitted when the fuse is replaced. If you lose the fuse cover, the plug must not be used until a replacement cover is obtained. A replacement fuse cover can be purchased from your local Panasonic dealer.

IF THE FITTED MOULDED PLUG IS UNSUITABLE FOR THE AC OUTLET IN YOUR PREMISES, THEN THE FUSE SHOULD BE REMOVED AND THE PLUG CUT OFF AND DISPOSED OF SAFELY. THERE IS A DANGER OF SEVERE ELECTRICAL SHOCK IF THE CUT-OFF PLUG IS INSERTED INTO ANY 13 AMP SOCKET.

How to replace the fuse: Open the fuse compartment with a screwdriver and replace the fuse and fuse cover.

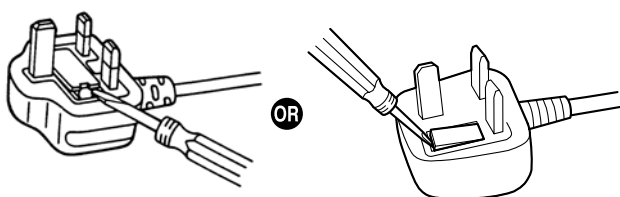

For users in the European Union only

Disposal of Old Equipment and Batteries Only for European Union and countries with recycling systems



These symbols on the products, packaging, and/or accompanying documents mean that used electrical and electronic products and batteries must not be mixed with general household waste.

For proper treatment, recovery and recycling of old products and used batteries, please take them to applicable collection points in accordance with your national legislation.

By disposing of them correctly, you will help to save valuable resources and prevent any potential negative effects on human health and the environment.

For more information about collection and recycling, please contact your local municipality.

Penalties may be applicable for incorrect disposal of this waste, in accordance with national legislation.

For business users in the European Union

If you wish to discard electrical and electronic equipment, please contact your dealer or supplier for further information.



Information on disposal in other countries outside the European Union

These symbols are only valid in the European Union. If you wish to discard these items, please contact your local authorities or dealer and ask for the correct method of disposal.



Note for the battery symbol (bottom symbol)

This symbol might be used in combination with a chemical symbol. In this case it complies with the requirement set by the Directive for the chemical involved.

Precaution

For users in Taiwan only

Notice

- This product contains a CR coin lithium battery. When disposing of the product, the battery must be removed. Contact your dealer for details.



廢電池請回收



Direct current symbol



Alternating current symbol



This symbol indicates a warning symbol could get hot and there is a possible RISK of a burn if touched.

We declare under our sole responsibility that the product to which this declaration relates is in conformity with the standards or other normative documents following the provisions of Directives 2006/95/EC and 2004/108/EC.

For Malaysia Battery Regulation

Panasonic Malaysia Sdn. Bhd.
 Lot 10, Jalan 13/2, 46200 Petaling Jaya, Selangor
 Darul Ehsan, Malaysia

For users in Germany only

- Machine Noise Information Ordinance, 3rd GPSGV: The highest sound pressure level is 70 dB (A) or less according to EN ISO 7779.
- This equipment is not for use at video display work stations according to BildscharbV.

For Canada

CAN ICES-3(A)/NMB-3(A)

For U.S.A.

This product contains a CR Coin Cell Lithium Battery which contains Perchlorate Material - special handling may apply.

See www.dtsc.ca.gov/hazardouswaste/perchlorate/

FCC Note: This equipment has been tested and found to comply with the limits for a Class A digital device, pursuant to Part 15 of the FCC Rules. These limits are designed to provide reasonable protection against harmful interference when the equipment is operated in a commercial environment. This equipment generates, uses, and can radiate radio frequency energy and, if not installed and used in accordance with the instruction manual, may cause harmful interference to radio communications. Operation of this equipment in a residential area is likely to cause harmful interference in which case the user will be required to correct the interference at his own expense.

FCC Caution: To assure continued compliance, (example - use only shielded interface cables when connecting to other devices). Any changes or modifications not expressly approved by the party responsible for compliance could void the user's authority to operate this equipment.

The model number and serial number of this product may be found on the surface of the unit. You should note the model number and serial number of this unit in the space provided and retain this book as a permanent record of your purchase to aid identification in the event of theft.

Model No. _____

Serial No. _____

Disposal may be regulated in your community due to environmental considerations. For disposal or recycling information, please visit Panasonic website: <http://www.panasonic.com/environmental> or call 1-888-769-0149.

Accessory/Optional Accessory Information

The following accessories are included:

Included Accessories

Accessories	Quantity
AC adaptor Part No.:PGLV1006 (KX-VC1000/KX-VC1300/KX-VC1600/ KX-VC1000SX/KX-VC1300SX/KX-VC1600SX) Part No.:PGLV1011 (KX-VC1300A/KX-VC1600A) Part No.:PGLV1017 (KX-VC2000/KX-VC2000SX)	1
Power cord	Depends on country/area
Remote control Part No.:N2QAYB001001 (KX-VC1000SX/KX-VC1300SX/ KX-VC1600SX/KX-VC2000SX/KX-VC1300A/KX-VC1600A) Part No.:PGVF2294ZAV1 (KX-VC1000/KX-VC1300/KX-VC1600/ KX-VC2000)	1
Batteries R6 [AA] dry cell (KX-VC1000/KX-VC1300/KX-VC1600/ KX-VC2000/KX-VC1300A/KX-VC1600A) LR6 [AA] dry cell (KX-VC1000SX/KX-VC1300SX/ KX-VC1600SX/KX-VC2000SX)	2



Note

- The number and type of power cords may vary depending on the country/area of use. Please use whichever is appropriate for the country/area.

Optional Accessory

The following products are available as optional accessories.

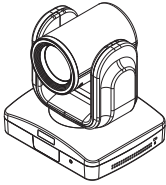
Proprietary main video camera

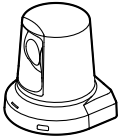
<p>Proprietary main video camera 12x optical/10x digital zoom Pan/tilt function supported</p>	<p>Proprietary main video camera 12x optical/10x digital zoom Pan/tilt function supported</p>
	
<p>Model No.: KX-VD170</p>	<p>Model No.: GP-VD151</p>
<p>Proprietary main video camera 3x optical/4x digital zoom Pan/tilt function supported</p>	
	
<p>Model No.: GP-VD131</p>	

Boundary Microphone

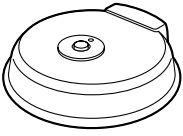
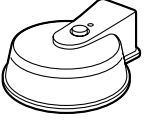
<p>Boundary Microphone (Digital Interface Type) (Proprietary cable included. Cable length: approx. 8.5 m [28 ft])</p>	<p>Boundary Microphone (Analogue Interface Type) (Proprietary cable included. Cable length: approx. 7 m [23 ft])</p>
	
<p>Model No.: KX-VCA001</p>	<p>Model No.: KX-VCA002</p>

Activation Keys

You can enhance the following types of features with an activation key. For details about the settings, refer to "Activating Enhanced Features" (Page 158).

Model No.	Product Name	Activation Key Type	Target Model	Description
KX-VCS302	Activation Key (Multicast)	Multicast	KX-VC1000 KX-VC1300 KX-VC1600 KX-VC2000	Enables the multicast feature.
KX-VCS304	Activation Key (4 Point Built-in MCU)	4 Point Built-in MCU	KX-VC1600	Enables the feature for making multiple-party video conference calls with 10 parties, rather than the default maximum of 6 parties.
KX-VCS305	Activation Key (4 Point Built-in MCU for KX-VC2000)	4 Point Built-in MCU	KX-VC2000	Enables the feature for making multiple-party video conference calls with 20 or 24 parties, rather than the default maximum of 16 parties.
KX-VCS314	Activation Key (4 Point Built-in MCU for KX-VC1000)	4 Point Built-in MCU	KX-VC1000	Can establish connections with a maximum of 4 parties.
KX-VCS351	Activation Key (Mobile Connection)	Mobile Connection	KX-VC1000 KX-VC1300 KX-VC1600	Connects to a mobile device in IP Mode.
KX-VCS352	Activation Key (Mobile Connection for KX-VC2000)	Mobile Connection	KX-VC2000	Connects to a mobile device in IP Mode.
KX-VCS402	Activation Key (HDMI for KX-VC1000 Dual Monitor)	HDMI Dual Monitor	KX-VC1000	Enables HDMI2 output.
KX-VCS701	Activation Key (NAT Traversal 1 Year)	NAT Traversal 1 Year	KX-VC1000 KX-VC1300 KX-VC1600 KX-VC2000	Extends the service period of KX-VC Series NAT Traversal Service.
KX-VCS703	Activation Key (NAT Traversal 3 Years)	NAT Traversal 3 Years	KX-VC1000 KX-VC1300 KX-VC1600 KX-VC2000	Extends the service period of KX-VC Series NAT Traversal Service.

Model No.	Product Name	Activation Key Type	Target Model	Description
KX-VCZ501	PC Peripheral kit	PC Peripheral	KX-VC1000 KX-VC1300 KX-VC1600 KX-VC2000	Enables the USB Device Mode feature.

Part Names and Usage

Main Unit (Front)

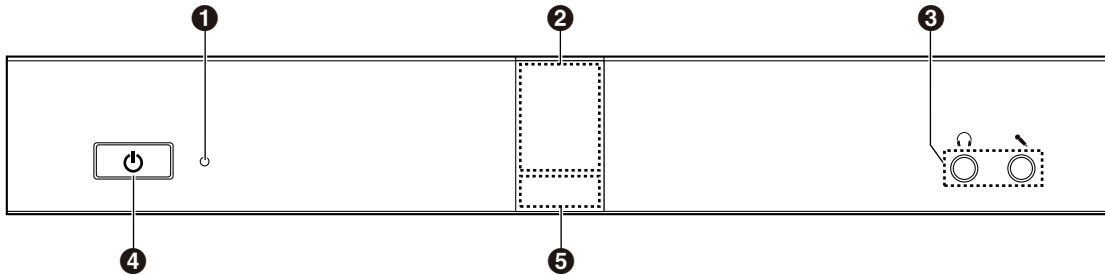

- 1 Power LED**
Shows the power status. The LED is green or red when power is being supplied from the AC adaptor, and off when power is not being supplied.
- 2 Remote Control Signal Receiver**
Receives Remote Control signals. The maximum range of reception is approximately 8 m (26.2 ft) from front of the unit, and approximately 3 m (9.8 ft) from 20° on each side, total 40°.
- 3 Headset Input-Output Terminal**
Used to connect a headset to the unit (Page 34).

Note

- If a headset is connected, audio from the other party can be heard through the headset. Audio is not played through the display or speakers. However, if **"Output local site sound"** is set to **"HDMI"**, audio is output via HDMI, not the headset (Page 152).
- If a headset is connected, how audio is sent to the other party differs depending on the type of devices connected as follows:

Connected Device	Audio Sent to Other Party
Boundary Microphone	Audio is picked up only by the headset microphone. Audio is not picked up by the Boundary Microphones.
General-purpose microphone	Both the general-purpose microphones and the headset microphone pick up audio.
Boundary Microphone and general-purpose microphone	Both the general-purpose microphones and the headset microphone pick up audio. The Boundary Microphones do not pick up audio.

- 4 Power button**
Turns the power on and off (Page 40).
- 5 Status LED**
Shows the operational status of the unit (Page 27).

Main Unit (Back)

KX-VC1600/KX-VC2000

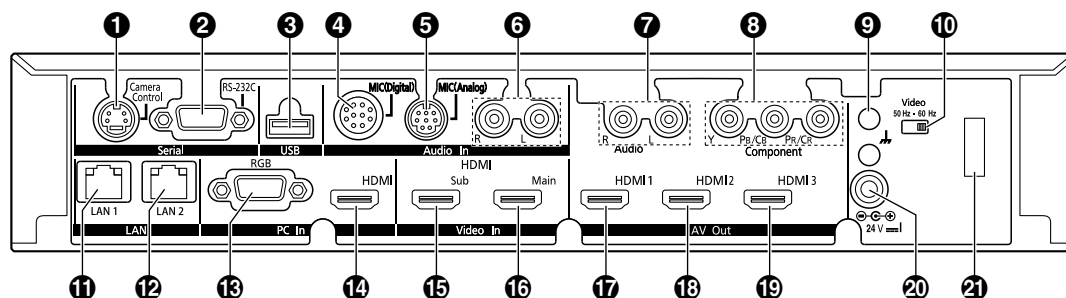

KX-VC1300

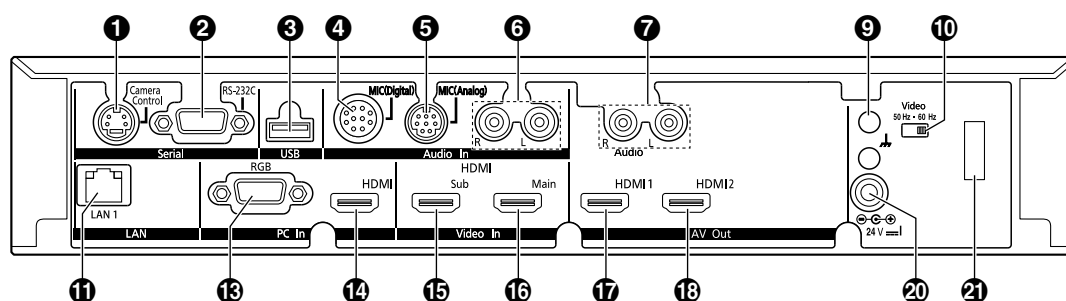

KX-VC1000

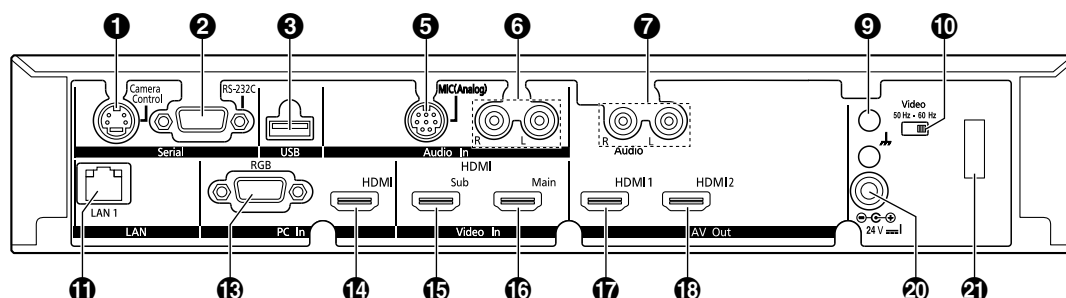

- 1 Camera Control terminal**
Not used.
- 2 RS-232C terminal**
Normally not used. Used to connect a computer for maintenance.
- 3 USB jack (Page 156, Page 159, Page 183, Page 186)**
Used to connect a USB memory device to save the operation log, save recorded movies, and update the software, or used for USB Device Mode.
- 4 MIC (Digital) jack (Except KX-VC1000) (Page 30)**
Used to connect the Digital Boundary Microphone (optional) (Page 19).
- 5 MIC (Analog) jack (Page 30)**
Used to connect the Analogue Boundary Microphone (optional) (Page 19).
- 6 Audio In L/R jack (Page 31)**
Used to connect general-purpose microphones (not for the Boundary Microphone).
- 7 Audio Out L/R jack**
Used to connect an amplifier or active speaker (Page 35). Also used to connect the speakers of a display without an HDMI terminal for audio output (Page 36).

- 8 Component terminal (KX-VC1600/KX-VC2000) (Page 36)**
Used to connect to the display with a component video cable.
- 9 Functional Earth terminal**
Used to connect an earthing wire for when there is a lot of noise over the connection.
- 10 Video Switch**
Used to set the unit's video frequency. Sets the unit's video frequency to be the same as the connected device.
- 11 LAN1 jack (Page 31)**
Connect a LAN cable.
- 12 LAN2 jack (KX-VC1600/KX-VC2000) (Page 31)**
Connect a LAN cable (Used when connecting to a network other than LAN1).
- 13 RGB terminal (Page 34)**
Used to connect a computer for sending screens to participants.
- 14 HDMI terminal (Page 34)**
Used to connect a computer for sending screens to participants.
- 15 Sub Camera terminal (Page 34)**
Used to connect a second, sub video camera with an HDMI cable for sharing video contents apart from the main video camera.
- 16 Main Camera terminal (Page 30)**
Connect the main video camera with an HDMI cable.
- 17 HDMI1 terminal (Page 30)**
Used to connect to the display with an HDMI cable.
- 18 HDMI2 terminal (Page 30)**
Used to connect to the display with an HDMI cable. Settings are required to use the HDMI2 terminal (Page 150). When using the KX-VC1000, after using an activation key to enable HDMI Dual Monitor support, remove the protective seal (Page 20).
- 19 HDMI3 terminal (KX-VC1600/KX-VC2000) (Page 30)**
Used to connect to the display or a video recorder with an HDMI cable. Used to switch the displayed image between your image and recorded video.
- 20 DC IN (Page 31)**
Connect the AC adaptor's DC cord.
- 21 Hook**
Used to prevent the DC IN connection from becoming unplugged.

Remote Control

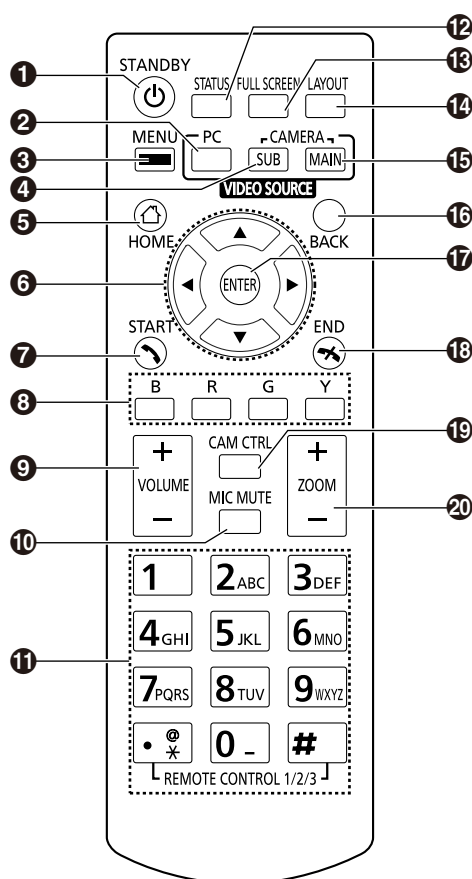

- ❶ Press to enter screen standby mode (Page 27). The power of the unit can be turned on/off by pressing and holding (for 1 second). During communication, the power of the main unit cannot be turned off.
- ❷ Press to show your computer's screen on your and the other party's display during a video conference call. When not on a video conference call, the computer screen is shown on your display only (Page 89).
- ❸ Press to display the Menu screen (Page 44).
- ❹ Press to show the sub video camera's images on your and the other party's display during a video conference call. When not on a video conference call, the sub video camera's images are shown on your display only (Page 89).
- ❺ Press to display the Home screen (Page 41).
- ❻ Press to move the cursor, control the PT (Pan/Tilt) of a video camera, and select items.
- ❼ Press to make or manually answer video conference calls (Page 51, Page 63).
- ❽ Press to select the feature assigned to each colour. Available features are displayed in the guide area (Page 43).
- ❾ Press to adjust the volume during a video conference call. Press **[+]** to increase and **[-]** to decrease the volume (Page 85).
- ❿ Press to mute the microphone during a video conference call, so that the other party cannot hear your voice (Page 86).
- ⓫ Press to dial or perform settings where inputting digits/characters is required (Page 190).
- ⓬ Press to display the connection status of the network and peripheral devices (Page 103).
- ⓭ Press to show/hide on-screen information, such as the guide area, on the Home screen and the video conference call screen (Page 45).
- ⓮ Press to change the layout of the screen during a video conference call (Page 71).
- ⓯ Press to return to the main video camera after showing images from a computer or sub video camera (Page 89).

Preparation

- 16 Press to return to the previous screen.
- 17 Press to confirm the selected item or entered information.
- 18 Press to end a video conference call.
- 19 Press to display the camera control screen (Page 93).
- 20 Press for zoom control (zoom in/out) of the video camera either at your end or the other party's end (Page 92).

LED Indication

LEDs indicate the operational status of the unit, as follows:

Power LED	Status LED	Status
Off	Off	<ul style="list-style-type: none"> AC power: OFF (Without power supplied from the AC adaptor)
Red on	Off	<ul style="list-style-type: none"> AC power: ON (Power button: OFF)
Green flashing	Blue flashing	<ul style="list-style-type: none"> Starting up
Red flashing	Off	<ul style="list-style-type: none"> A hardware fault has occurred.
Green on	Blue flashing	<ul style="list-style-type: none"> Startup state Idle state
Green on	Blue on	<ul style="list-style-type: none"> In a video conference call
Green on	Yellow on	<ul style="list-style-type: none"> Self diagnosis is being performed.
Green on	Red on	<ul style="list-style-type: none"> An error has occurred. Maintenance is being performed. Software update in progress
Green on	Red flashing	<ul style="list-style-type: none"> A serious error has occurred.
Red on	Red flashing	<ul style="list-style-type: none"> The CPU cooling fan has stopped (KX-VC2000 only).
Green on	Off	<ul style="list-style-type: none"> In screen standby mode

Screen Standby

When there is no video conference call transmission, and the remote control is not operated for more than 10 minutes (default), or when the remote control's **[STANDBY]** button is pressed, the unit enters screen standby mode. Video out to the display is suspended and the status LED turns off.

Screen standby mode ends when the remote control is operated, or when a video conference call is received.

Notice

- If screen standby mode ends and no image is visible, check to see if the display or video camera's power saving settings are enabled. Check each device's manual for more information about its power saving settings.

Note

- You can change the length of time until the unit enters screen standby mode (Page 127).
- The unit will not enter screen standby mode while displaying a computer's screen or a sub video camera's image, even if the remote control is not operated for a period of time.
- When the remote control is operated and screen standby mode ends, the Home screen will be displayed.
- If a button is pressed on the remote control to end screen standby mode, that button's operation is not performed in that case.
- If screen standby mode begins while editing information in the contact list or other screen, any unsaved changes will be lost.

Preparation

- It takes about 7 seconds to return from screen standby mode. (The length of time may vary depending on the type of display you are using.)
- The unit will not enter screen standby mode during USB recording and USB Device Mode.

Connection and Preparation

Device and Network Connection

In addition to the unit, you will need a video camera, a display, a microphone (Boundary Microphone or general-purpose microphone) and connection cables for visual communication.

Apart from the Boundary Microphone, the other devices must meet the following conditions:

Device	Condition
Video Camera	HDMI output required (resolution: 1080p/1080i/720p)
Display ¹	HDMI/component input required Make sure that the video frequencies of the unit and display match.
General-purpose microphone	Line level output required (In case of microphone level output, microphone amplifier also required)

¹ If displays are connected using both the HDMI terminal and Component terminal, connect to displays that have the same resolution (Page 151).

Cables

Prepare the following commercially available cables:

HDMI cable:

Category 2 (high speed) recommended

Note

- Use cables with the HDMI logo (certified HDMI cables) for HDMI connection. Using non-certified cables may adversely affect operation. Use HDMI cables with secure connectors.

LAN cable:

1000BASE-T/100BASE-TX/10BASE-T (full duplex)
Category 5 or greater

VGA cable (for computer connection when using the secondary video source):

15-pin mini D-Sub

Note

- Ensure that the cables match the sockets of both the unit and your computer.

Stereo pin plug cable (for connecting a general-purpose microphone/amplifier/active speaker/display [without an HDMI terminal and with speakers]):

RCA plug

Network Environment

When using the unit over the Internet, a broadband connection is required.

Connecting the Unit

This section describes how to connect the main video camera, display, microphone, LAN cable, AC adaptor and power cord.

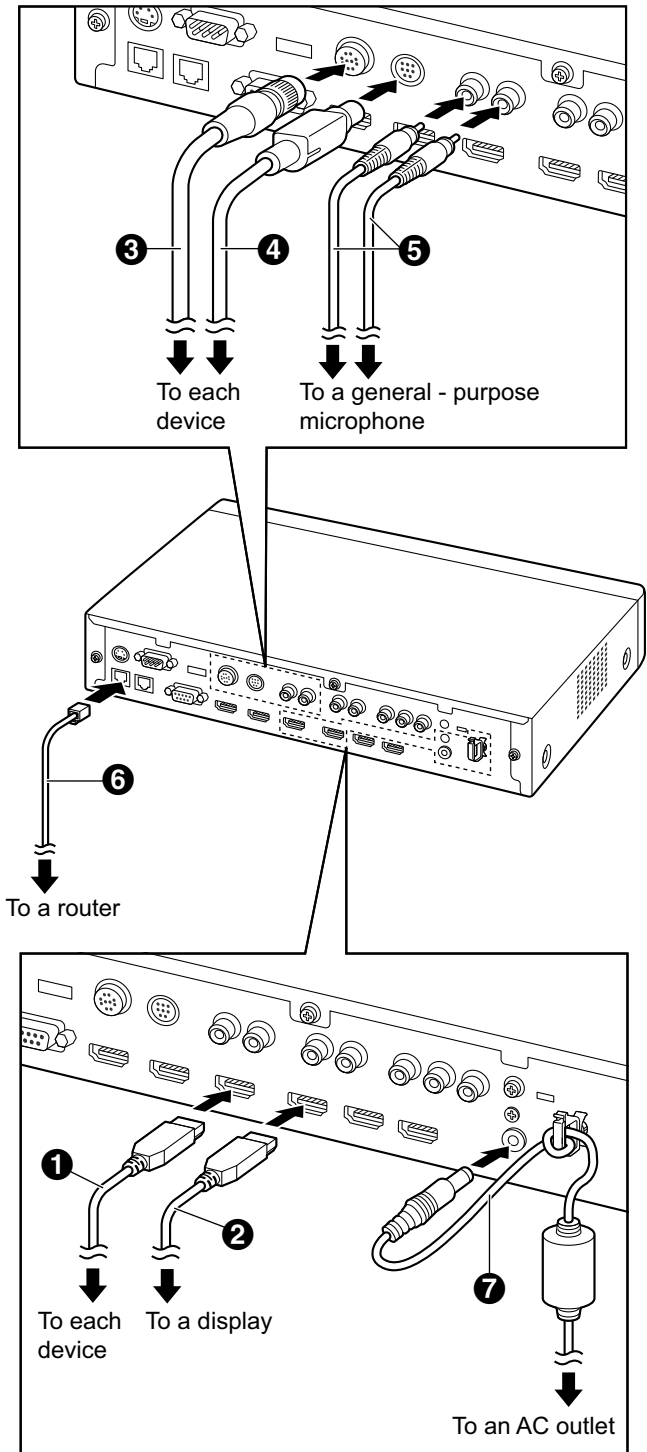

Notice

- Use only the included power cord.

Note

- Make sure to read the instruction manuals for all devices being connected.
1. Connect the main video camera.
 - Connect the main video camera to the Main Camera terminal on the back of the unit using an HDMI cable (1).
 2. Connect the display.
 - Connect the display to the HDMI 1-3 terminals on the back of the unit using an HDMI cable (2).

Note

- The HDMI3 terminal on the back of the unit switches between output of your own image and recorded images. When recording, connect the recording device to the HDMI3 terminal, and set the output to that for recording (Page 151).
- If your display is not compatible with HDMI, use a component cable. Since sound signals are not transmitted when using a component cable, connect an amplifier/active speaker, or use the display's speakers.
- If "game mode" can be selected in the display's settings, set "game mode". It may improve voice delay.

3. Connect a microphone.

Digital Boundary Microphone (optional)

Connect the Digital Boundary Microphone to the MIC (Digital) jack on the back of the unit using the proprietary cable (3).

- Use only the included cable.
- Push and turn the connector of the proprietary cable until it clicks. If the connector does not click, try reconnecting the cable with the top and bottom of the connector reversed.

Analogue Boundary Microphone (optional)

Connect the Analogue Boundary Microphone to the MIC (Analog) jack on the back of the unit using the proprietary cable (4).

- Use only the included cable.
- Ensure that the arrow on the connector of the proprietary cable is facing up when you insert

the cable. When you disconnect the cable, grip the connector securely and pull it out.

General-purpose microphone

Connect the microphone to the Audio In L/R jack on the back of the unit using the stereo pin plug cable (5) after amplifying the signal to line level using a device such as a microphone amplifier.

- Connect the microphone correctly, as follows:
 - Left channel → L
 - Right channel → R

Note

- When connecting both the Boundary Microphone and a general-purpose microphone, both microphones can be used simultaneously.
- When connecting a headset, refer to "Headset Connection (Page 34)".

4. Connect to the network.

- Connect a hub/router to the LAN jack on the back of the unit using a category 5 or greater LAN cable (6).

Note

- Set the hub/router to Auto Negotiation mode.
- Do not connect to a hub/router set to Half Duplex.
- For more details about routers and DCEs, refer to the documentation for each device.

5. Connect the power cord to the AC adaptor.

- Use only the power cord included with the unit.

6. Insert the AC adaptor's DC cord (7) into the DC IN terminal on the back of the unit.

- Use only the AC adaptor included with the unit.
- Wrap the DC cord around the hook to prevent it from being disconnected.

7. Plug in the power cord into the power outlet.

- Choose an outlet that is convenient for plugging/unplugging.

System Layout Examples

Display and Main Video Camera

Place the display and main video camera at the same side of the room.

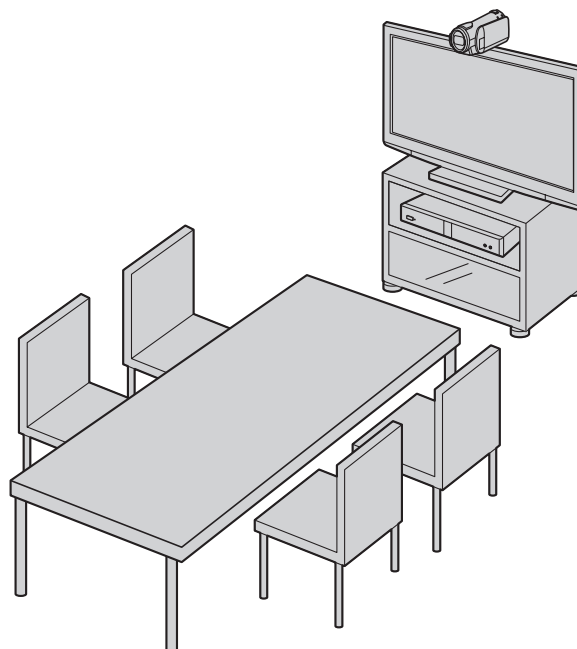

Note

- If you use speakers, refer to "Amplifier/Active Speaker Connection" (Page 35).

Digital Boundary Microphones

Up to 4 Digital Boundary Microphones can be connected in cascade. There are no separate terminals for input and output on the Boundary Microphones. Also, an Analogue Boundary Microphone and general-purpose microphones can be used simultaneously.

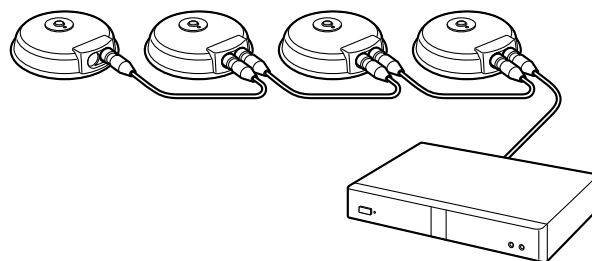

Note

- Make sure that the microphones are placed at least 1 m (3.3 ft) away from the display and speakers.

Preparation

- Do not connect more than 4 Digital Boundary Microphones. Doing so will cause all Digital Boundary Microphones to stop working. If an Analogue Boundary Microphone is also connected, all audio input from the Analogue Boundary Microphone will also stop working.
- If both of the following conditions are met, the output sent to the other party will be stereo; otherwise, monaural:
 - The bandwidth is higher than approximately 1.8 Mbps in a 2-party video conference call with the HD Visual Communication Unit.
 - The MIC position is set automatically or manually to collect a sound in stereo.
- If a headset is connected, audio from the headset microphone is given priority, and audio from Digital Boundary Microphones is no longer picked up.

The range of each microphone (the radius of the circle with a microphone at the centre) varies according to the level of surrounding and the number of microphones being used. Place microphones accordingly, referring to the following table.

Noise level/ Microphone	A quiet room (40 dBsplA)	A regular room (45 dBsplA)	A noisy room (50 dBsplA)
1	approx. 3 m (approx. 9.8 ft)	approx. 2.2 m (approx. 7.2 ft)	approx. 1.2 m (approx. 3.9 ft)
2	approx. 2.8 m (approx. 9.2 ft)	approx. 1.5 m (approx. 4.9 ft)	approx. 1 m (approx. 3.3 ft)
3	approx. 2.3 m (approx. 7.5 ft)	approx. 1.3 m (approx. 4.3 ft)	—
4	approx. 2 m (approx. 6.5 ft)	approx. 1.1 m (approx. 3.6 ft)	—

Layout examples (a regular room)
(the grey circle indicates the microphone's range):

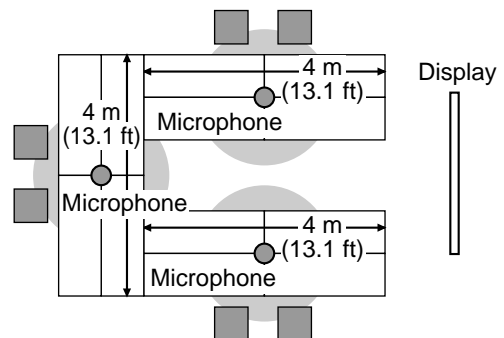
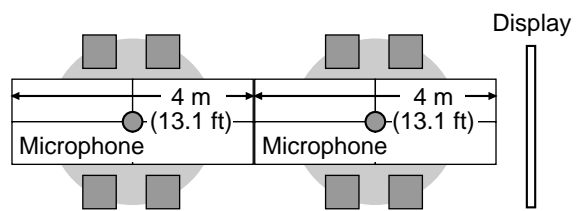
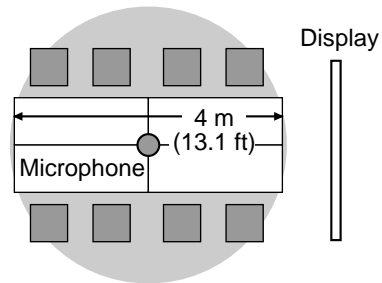

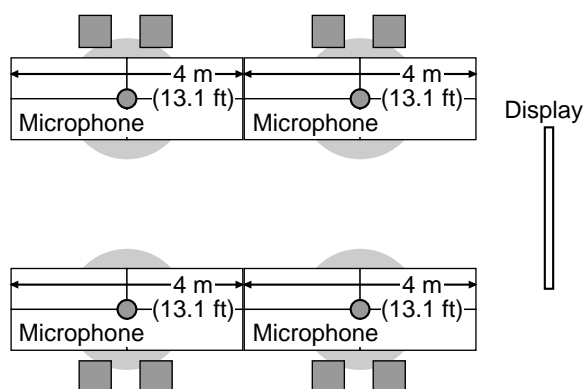

Analogue Boundary Microphones

You can connect 1 Analogue Boundary Microphone. Together with Digital Boundary Microphones, up to 5 boundary microphones can be connected.

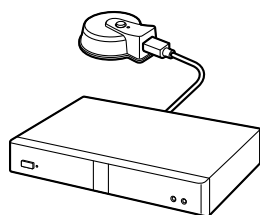

Note

- Make sure that the microphone is placed at least 1 m (3.3 ft) away from the display and speakers.
- Make sure that the microphone is placed with its connector facing the display.
- If both of the following conditions are met, the output sent to the other party will be stereo; otherwise, monaural:
 - The bandwidth is higher than approximately 1.8 Mbps in a 2-party video conference call with the HD Visual Communication Unit.
 - You are not using Digital Boundary Microphones and an Analogue Boundary Microphone together.
- If a headset is connected, audio from the headset microphone is given priority, and audio from Analogue Boundary Microphones is no longer picked up.

The range of the microphone (the radius of the circle with a microphone at the centre) varies according to the level of surrounding noise. Place the microphone accordingly, referring to the following table.

Noise level/ Microphone	A quiet room (40 dBsplA)	A regular room (45 dBsplA)	A noisy room (50 dBsplA)
1	approx. 2 m (approx. 6.5 ft)	approx. 1.5 m (approx. 4.9 ft)	approx. 1 m (approx. 3.3 ft)

Headset Connection

You can connect a headset to the headset jack on the front of the unit.

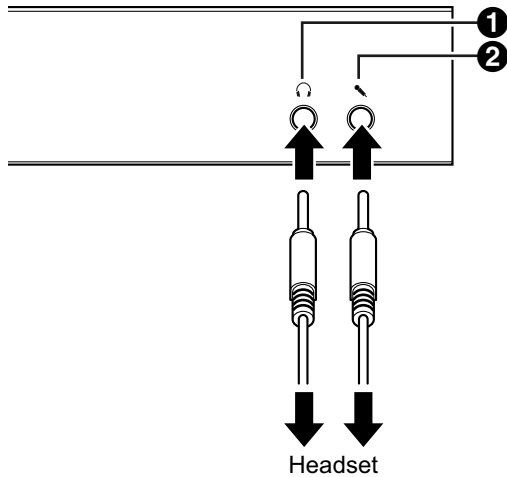

Note

- Check the headphone connector (1) and the microphone connector (2), and then connect the headset.
- If a Boundary Microphone and a headset are connected at the same time, audio from the headset microphone is given priority, and audio from Boundary Microphones is no longer picked up.
- If a general-purpose microphone and a headset are connected at the same time, audio from both sources is picked up.
- If a headset is connected, audio will not be played through the display or speakers.
- When using HDMI3 as a video/audio recording terminal, audio will be output even when a headset is connected. (KX-VC1600/ KX-VC2000)
- For 3-conductor stereo mini-plugs only.

Sub Video Camera Connection

This section describes how to connect a sub video camera. You can transmit images taken with the sub video camera to all parties.

1. Connect the sub video camera.
 - Connect the sub video camera to the Sub Camera terminal on the back of the unit using an HDMI cable.

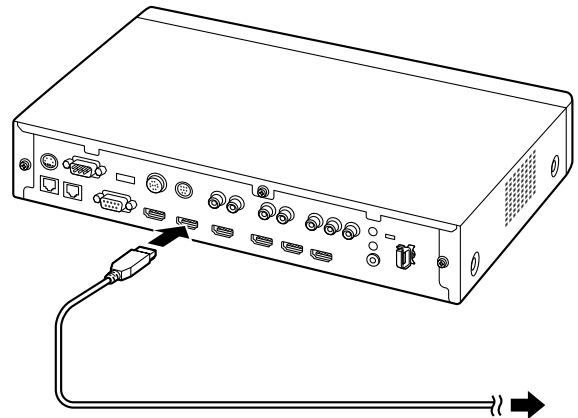

Note

- You can connect/disconnect the sub video camera during a video conference call.

Computer Connection

This section describes how to connect a computer. Connecting a computer allows you to show the computer screen's images on the display and transmit them to other parties.

You can transmit the computer's images to all parties.

1. Connect the computer.
 - Connect the computer to the HDMI terminal on the back of the unit using an HDMI cable.

- For computers without HDMI ports, connect the computer to the RGB terminal on the back of the unit using a VGA cable.

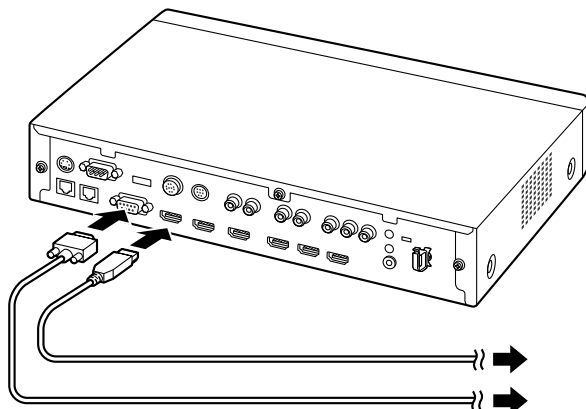

Note

- You can connect/disconnect the computer during a video conference call.
- One of the following resolutions is required for transmitting computer images: VGA (640 × 480), SVGA (800 × 600), XGA (1024 × 768), HD (1280 × 720), WXGA (1280 × 768, 1280 × 800), SXGA (1280 × 1024), FWXGA (1360 × 768, 1366 × 768), WXGA+ (1440 × 900), WXGA++ (1600 × 900), UXGA (1600 × 1200), WSXGA+ (1680 × 1050), Full-HD (1920 × 1080).
- If both HDMI and VGA cables are connected to the unit, the image of the computer connected using an HDMI cable will be displayed.

Amplifier/Active Speaker Connection

This section describes how to connect an amplifier/active speaker.

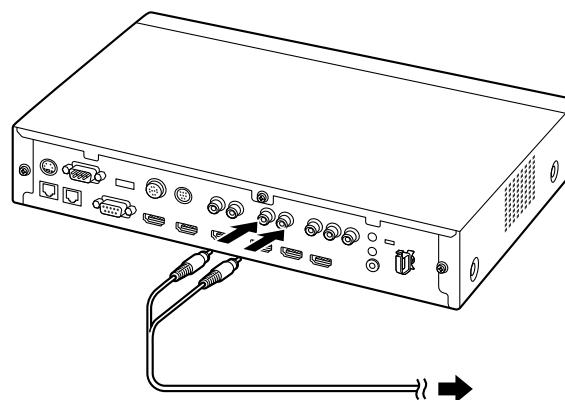

- Connect the amplifier/active speaker to the Audio Out L/R jack on the back of the unit using a stereo pin plug cable.

Note

- Connect the amplifier/active speaker correctly, as follows:
 - Left channel → L
 - Right channel → R
- For more details about the amplifier or active speaker, refer to the documentation for the corresponding device.

Layout example:

Place the speakers either side of the display, as follows:

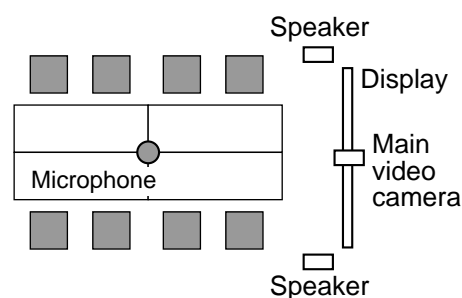

Notice

- Place the speakers either side of the display. If you place the display at the front of the room and the speakers at the back, the microphone's left/right spatial direction may be reversed, and the orientation of the image and sound will not match on the other party's side.

Connecting the Display with a Component Cable

If your display does not have an HDMI terminal, use a component cable for connection.

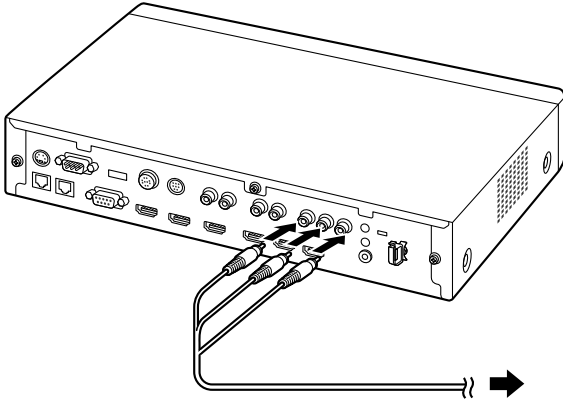

1. Connect the display to the Component terminal on the back of the unit using a component cable.

Note

- To use the display's speakers to output audio, connect the display to the Audio Out L/R jack (Page 23) on the back of the unit using a stereo pin plug cable.
- If displays are connected using both the HDMI terminal and Component terminal, connect to displays that have the same resolution.

Network Configuration Example

Diagram (when using the Internet/KX-VC Series NAT Traversal Service)
Compatible with LAN1

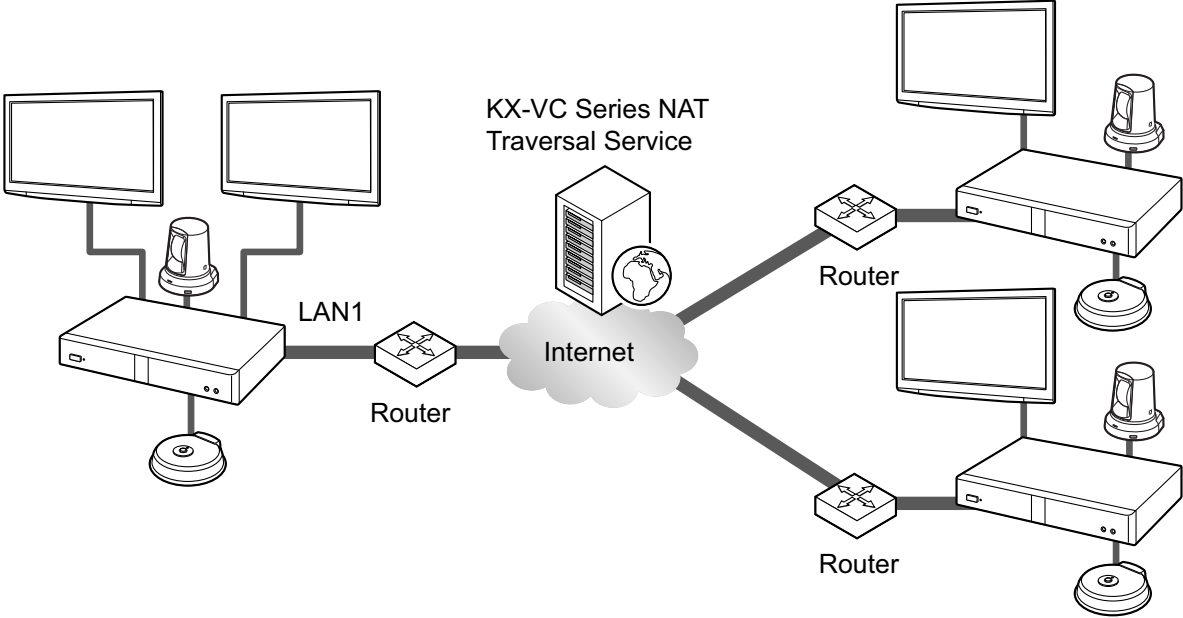

**Diagram (when using an intranet/KX-VC Series NAT Traversal Service)
Compatible with LAN1 and LAN2 (KX-VC1600/KX-VC2000)**

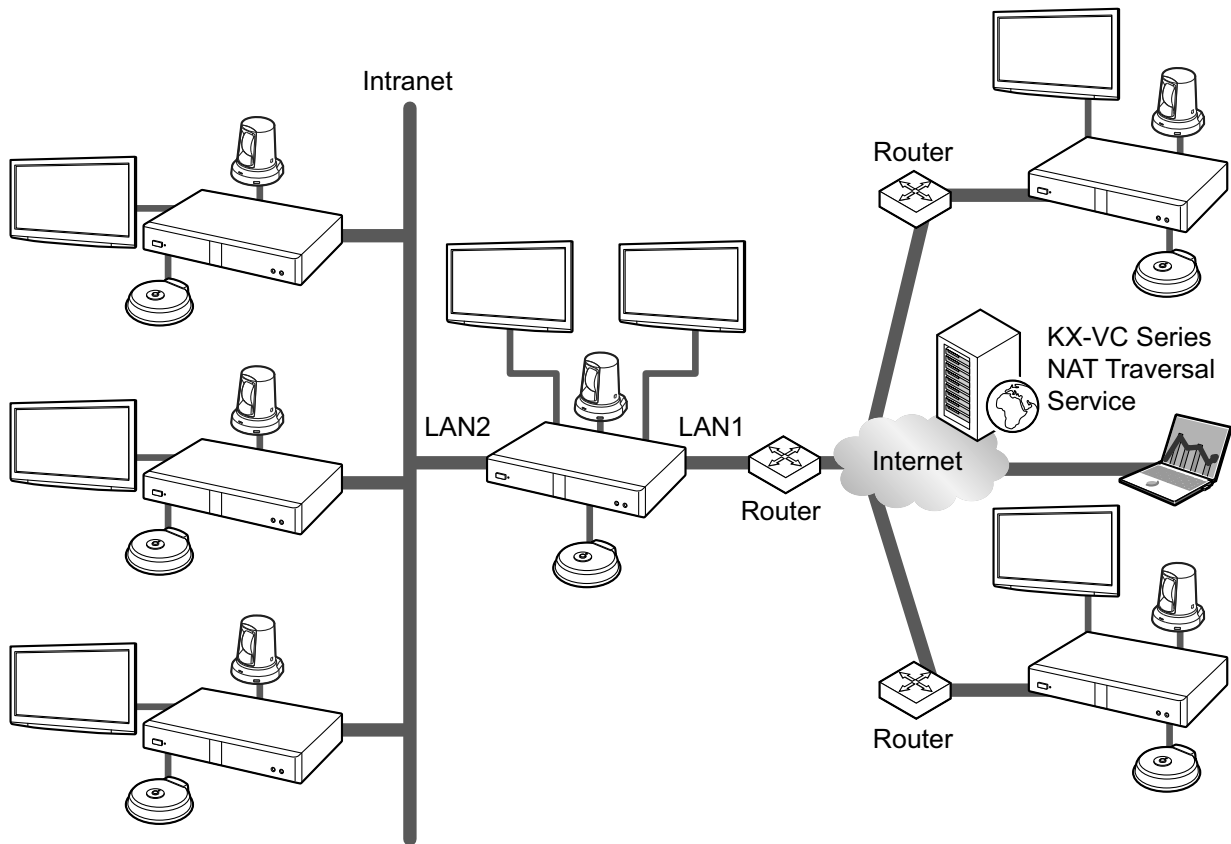

Note

When using a dual network (LAN1 and LAN2)

- Use LAN1 when using KX-VC Series NAT Traversal Service.
- The default gateway is in LAN1.
- NAT or DHCP can be used only in LAN1.

Preparing the Remote Control

Inserting Batteries

1. Open the cover.

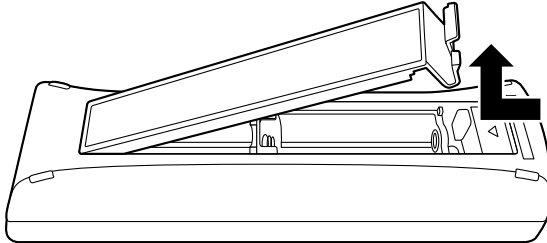

2. Insert batteries (R6/LR6 [AA] dry cell*), minus side first, then close the cover.

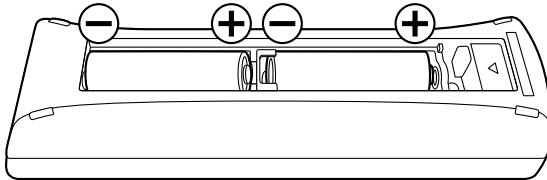

* R6 [AA] dry cell : KX-VC1000/KX-VC1300/KX-VC1600/KX-VC2000/KX-VC1300A/KX-VC1600A
LR6 [AA] dry cell : KX-VC1000SX/KX-VC1300SX/KX-VC1600SX/KX-VC2000SX

Turning the Power On/Off

Note

- Make sure that peripheral devices (e.g., display, main video camera) are turned on.
 - When you turn the power on for the first time, the Initial Settings screen is displayed (Page 48).
 - If the power is turned off by pulling out the AC adaptor when the Power LED is green, when the AC adaptor is inserted and power is supplied again, the status will go back that of when the power is turned on (the Power LED is green).
 - The power can be turned on or off automatically (Page 154).
- 1 Press the Power button on the front of the unit or on the remote control for more than 1 second. (Both can turn the power on or off.)
- When the power is turned on, the Power LED starts flashing green. Then, the Power LED becomes green, the Status LED starts flashing blue slowly, and the Home screen is displayed.

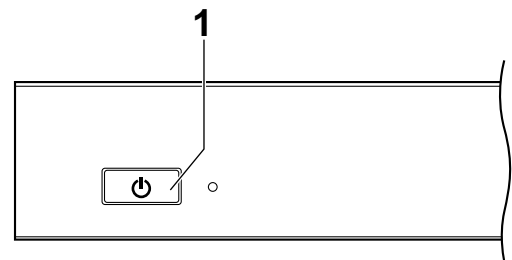
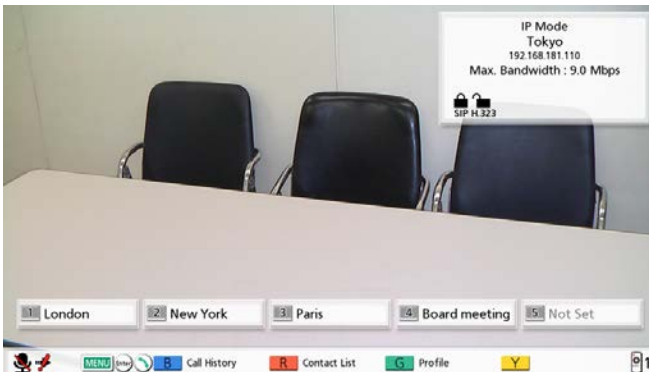

- When the power is turned off, the Power LED becomes red.

Screen Display

Home Screen (Idle Screen)

Displayed when the power is turned on. Also displayed when the **[Home]** button is pressed on the remote control.

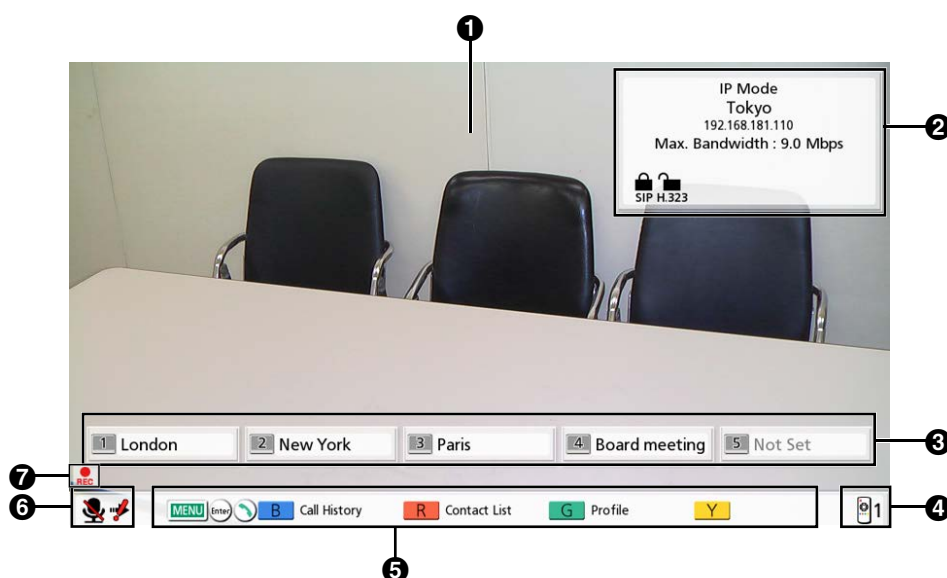

1 Main Video Camera Image

Displays the video from the main video camera.

2 Unit Information

The information displayed differs depending on the selected connection mode (Page 142).

IP Mode: The connection mode, local site name, the SIP user name (if using a SIP server)/H.323 extension, H.323 name (if using a gatekeeper), LAN1 IP address, LAN2 IP address (KX-VC1600/KX-VC2000), maximum bandwidth, encryption status indication icons, Static NAT status indication icon (if using the Static NAT feature), Local Camera Display of MCU Site icon, Profile standby icon, and Incoming Call from a non-regist. icon.

NAT Traversal Mode: The connection mode, local site name, Terminal ID, maximum bandwidth, encryption status indication icons, Local Camera Display of MCU Site icon, Profile standby icon, and Incoming Call from a non-regist. icon.







IP/NAT Traversal Mode: The connection mode, local site name, Terminal ID, LAN1 IP address, LAN2 IP address (KX-VC1600/KX-VC2000), maximum bandwidth, encryption status indication icons, Static NAT status indication icon (if using the Static NAT feature), Local Camera Display of MCU Site icon, Profile standby icon, and Incoming Call from a non-regist. icon.

Note

- When selecting a local site (Page 113), the selected local site's information is displayed. The local site's set device name is displayed. The information displayed differs depending on the local site's connection mode.
- If the local site name, SIP user name, H.323 extension, or H.323 name is too long to display, it will be shortened and ended with "...".

Encryption Status Indication Icons

The status of the encryption settings for SIP/H.323/NAT Traversal is indicated by icons. The icon changes as follows:

Icon	Status of Settings
	When using IP mode: "SIP" is set to "ON" and "Encryption (SIP)" is set to "ON" . When using NAT Traversal mode or IP/NAT Traversal mode: "Encryption (SIP)" is set to "ON" .
	When using IP mode: "SIP" is set to "ON" and "Encryption (SIP)" is set to "OFF" . When using NAT Traversal mode or IP/NAT Traversal mode: "Encryption (SIP)" is set to "OFF" .
	"H.323" is set to "ON" and "Encryption (H.323)" is set to "Best effort" .
	"H.323" is set to "ON" and "Encryption (H.323)" is set to "ON" .
	"H.323" is set to "ON" and "Encryption (H.323)" is set to "OFF" .
	When using NAT Traversal mode or IP/NAT Traversal mode: "Encryption (NAT Traversal)" is set to "ON" .
	When using NAT Traversal mode or IP/NAT Traversal mode: "Encryption (NAT Traversal)" is set to "OFF" .

Static NAT Status Indication Icon

Icon	Status of Settings
	When using IP mode, "Static NAT" is set to "ON" .

Local Camera Display of MCU Site Icon

Icon	Status of Settings
	"Local Camera Display of MCU Site" is set to "OFF" .



Profile standby Icon

Icon	Status of Settings
	Profile standby is set (page 112).

Incoming Call from a non-regist. Icon

Icon	Status of Settings
	"Incoming Call from a non-regist." is set to "OFF" (page 147).

- ③ **Group/Site**
Displays the name/group name assigned to One-Touch Connection number 1 through 5. If the name is too long to display, it will be shortened and ended with "...".
- ④ **Remote Control ID**
Displays the remote control ID of the unit when it is set (Page 130).
- ⑤ **Shortcut key**
Displays shortcut keys for accessing system settings (Page 155).
- ⑥ **Status Indication**
The status of the unit is indicated by icons.

Icon	Status
	Microphone is muted.
	Network, server (any kind), or peripheral connection error (no connection, device error, etc.). Note <ul style="list-style-type: none"> • If there are no connections, or there is a device error in other devices such as the LAN cable, the icon will be displayed.

Note

- If you set "**Active Home Menu**" to "OFF" in the administrator menu, you can hide ②③④⑤ (Page 153). When hidden, you can unhide them again by pressing **[FULL SCREEN]** on the remote control.

⑦ Icon Display Area

The status of the unit is indicated by icons.

Icon	Status
	Displayed when recording (Page 82, Page 132).

Menu Screen (Idle Screen)

Displayed when [MENU] is pressed on the remote control. Displays operations you can perform and settings you can change.

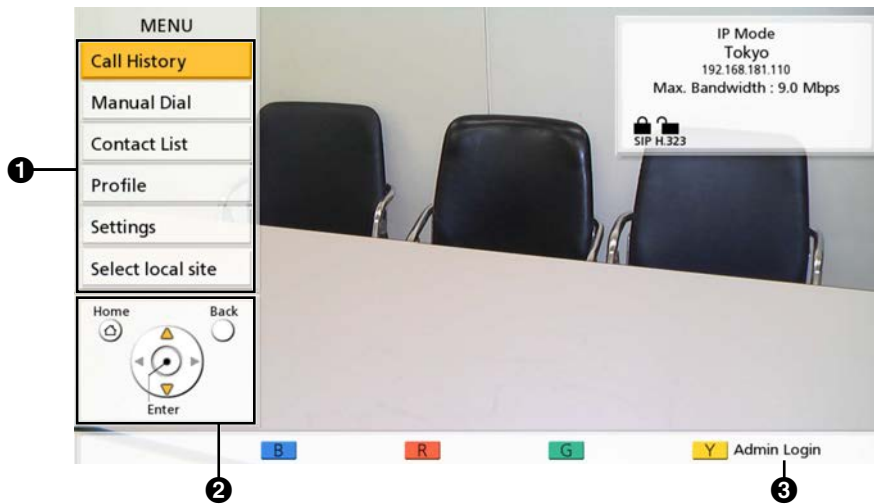

- 1 Menu List**
Displays the various functions you can use and settings available to change.
- 2 Guide**
Displays operations you can perform with the remote control when performing features or changing settings.
- 3 Administrator login**
Press [Y] to display the administrator login screen for performing administrator settings. Depending on the settings, "Admin Login" can be hidden and [Y] can be disabled (page 154).

Video Conference Call Screen



1 Other party's information

When using IP mode:

When registered in the contact list: The other party's name/IP address is displayed.

When not registered in the contact list: The other party's IP address, SIP URI (SIP user name@SIP domain name), host name (e.g., hdvc.example.com), H.323 extension, H.323 name, MCU's conference room number@IP address, or MCU's SIP user name@IP address is displayed. If the other party uses the same SIP domain as you, only the SIP user name, and not the SIP URI, is displayed.

When using NAT Traversal Mode:

- When registered in the contact list: The other party's name/connection number is displayed.
- When not registered in the contact list: The other party's connection number is displayed.

2 Video Image

Displays the other party's video, your own video, or video from the secondary video input such as a computer display or a sub video camera.

3 Subscreen

Depending on the screen layout, your own video or the other party's video is displayed here.

4 Duration

Displays the duration of the current video conference call.

Note

- 99h59m is displayed for the duration even if the length of the video conference call exceeds 100 hours.

5 Guide

Displays operations you can perform with the remote control.

6 Icon Display Area

Network Status Indication

The number of antennas in the icon indicates differing levels of network congestion.

The icon changes as follows:

0 bars (): The network is very congested or the bandwidth is insufficient at the connection point.

1 bar (): The network is congested.

2 bars (): The network is slightly congested.

3 bars (): The network is not congested.

Note

- If the icon shows only 0–1 bars continuously, contact your network administrator.
- During multiple-party video conference calls, the icon is displayed on each site screen, but not on your own image.
- You can set whether to display the icon. This setting affects all displayed images (excluding your own image) (Page 123). For example, if icon display has been enabled, the icon will be displayed on the image of all other parties, but not on your own image. However, if icon display has been disabled, the icon will not be displayed on any of the images. Regardless of icon display settings, the icon is not displayed while the combined computer/video feed screen is being displayed.

Other Site's Audio Indication ()

Displayed on the Main Site when "**Other Site's Audio**" is set to "**Mute**" during a multiple-party video conference call using the built-in MCU (Page 81, Page 108).

Dialling Indication ()

Displayed when a call is incoming at another site, such as when a site is added during a call or when a call is made (Page 67).

Presentation Mode Indication ()

Displayed for the main site for video conference calls with multiple connections that use an internal MCU when MCU mode is Presentation Mode (Page 77, Page 108, Page 124).

Recording icon ()

Displayed when recording (Page 82, Page 132).

7 Status Indication

The status of the unit is indicated by icons (Page 43).

Note

- Pressing **[FULL SCREEN]** on the remote control will hide or unhide the other party's information, duration, icon display area^{*1}, and guide displays.
- If a black line is displayed on the left of a site in the dialogue box for site selection during a call, it indicates that the site has the lowest bandwidth. If there are two types of communication groups due to "**Secondary Bandwidth Selection**" (Page 126), a black line is displayed on the site with the lowest bandwidth for each group.
Example: when Paris has the lowest bandwidth



^{*1} If the icons in the icon display area have been set to not be displayed, pressing **[FULL SCREEN]** will not show the icon.

Entering characters

You can use the remote control to input letters and numbers.

- Note the following regarding entering the address of the other party.
 - SIP user name/MCU's conference room number: alphanumeric characters, symbols . = * + _ - \$ ~ ! ? / () ' (up to 60 characters)
 - H.323 name: alphanumeric characters, symbols . @ : ; = * + # _ - \$ \ % ~ ^ ! ? / ` () [] { } ' (up to 60 characters)
 - SIP domain name: alphanumeric characters, symbols . - (up to 128 characters)
 - H.323 extension: numeric characters, symbols * # (up to 20 characters)
- For host names in the format of user name@domain name, characters and the number of characters that can be entered for user name and domain name are the same as for SIP user name and SIP domain name.
- The following characters can be used for input such as entering addresses in the contact list or directly entering the address of the party to call.
 - When using SIP: alphanumeric characters, symbols . @ : = * + _ - \$ ~ ! ? / () ' (up to 189 characters)
 - When using H.323: alphanumeric characters, symbols . @ : ; = * + # _ - \$ \ % ~ ^ ! ? / ` () [] { } ' (up to 189 characters)

When using SIP, the user name (portion before the @ mark) can be up to 60 characters, and the domain name (portion after the @ mark) can be up to 128 characters.
- Enter values that comply with the corresponding standard. For details, contact your network administrator.

About IPv6 Addresses

- When manually setting an IPv6 address, it may be entered in its shortened form or unshortened form.
 - (Input example)
 - 2001:db8::10
 - 2001:0db8::0010
 - 2001:db8:0:0:0:0:10
 - 2001:0db8:0000:0000:0000:0000:0010

Initial Settings

Note

- The Initial Settings screen is displayed when you turn the power on for the first time. It will not be displayed again afterwards.
 - After turning the unit on, you need to set the language, connection mode, device name, date and time, and network settings. These settings can be changed later.
- Press the Power button to turn on the unit.
 - The language settings screen is displayed.

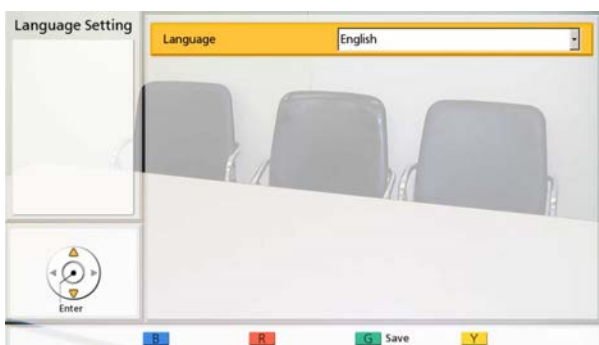

- Press [ENTER] and use [▲][▼] to select the desired language.

Note

- The language you can select is as follows: **"English"**: English (default), **"Deutsch"**: German, **"Français"**: French, **"Italiano"**: Italian, **"Español"**: Spanish, **"Nederlands"**: Dutch, **"Português"**: Portuguese, **"日本語"**: Japanese, **"Русский язык"**: Russian, **"简体中文"**: Chinese, **"العربية"**: Arabic.
 - When Chinese is selected, **"Arabic"** is displayed to select Arabic.
- Press [ENTER].
 - Press [G].
 - Use [◀][▶] to select **"Yes"** and press [ENTER].
 - The connection mode setting screen is displayed.

- Press [ENTER], use [▲][▼] to select the desired connection mode, and then press [ENTER] again.

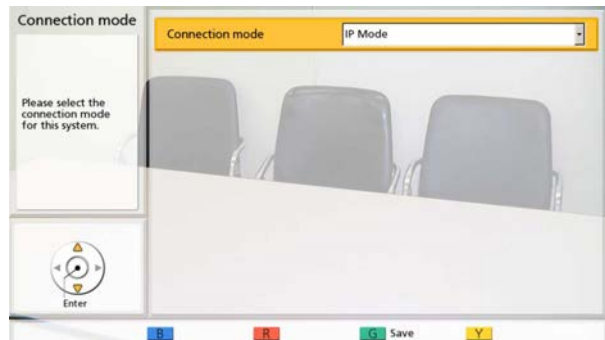

Note

- Calls cannot be made with other parties whose connection mode is different from yours.
- "NAT Traversal Mode"** or **"IP / NAT Traversal Mode"** can be used only after activating KX-VC Series NAT Traversal Service with an activation key.

- Press [G].
- Select **"Yes"** using [◀][▶], then press [ENTER].
 - The device name setting screen is displayed.
- Enter a name for the device (up to 24 characters) (Page 190).

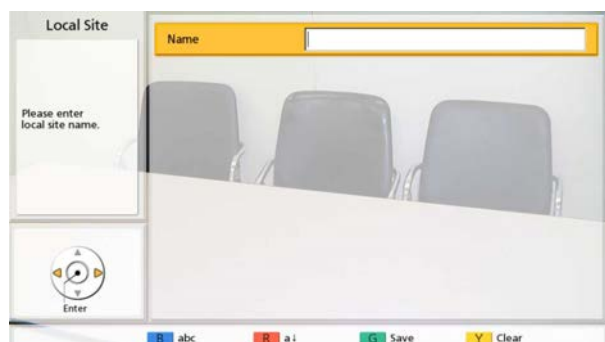

- Press [G].
- Select **"Yes"** using [◀][▶], then press [ENTER].
 - The date and time setting screen is displayed.
- Select the item using [▲][▼], then input information.
 - Enter the year (4 digits), month (1–2 digits), day (1–2 digits), time (24 hour display), and select

the date format (Month/Day/Year, Day/Month/Year, Year/Month/Day) and the hour display format (12h/24h).



13. Press [G].

14. Select "Yes" using [◀][▶], then press [ENTER].

- The network settings screen is displayed.

15. Use [▲][▼] to select the following items for input:

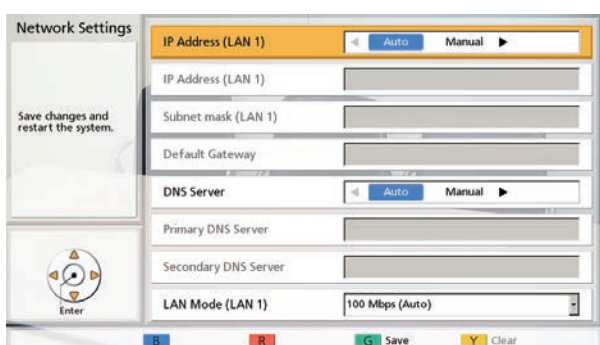

Note

- For the KX-VC1000/KX-VC1300, "IP Address (LAN 1)" (setting), "IP Address (LAN 1)", and "Subnet mask (LAN 1)" are respectively displayed as "IP Address" (setting), "IP Address", and "Subnet mask".

"IP Address (LAN 1)"(setting): Use [◀][▶] to select whether the IP address information for this unit ("IP Address (LAN 1)", "Subnet mask (LAN 1)", "Default Gateway") will be obtained automatically from a DHCP server or will be set manually.

- "Auto" (default): Obtain the IP address information automatically.
- "Manual": Set the IP address information manually.

Note

- Even if you have selected "Auto", you still may not be able to acquire an IP address due to problems such as network congestion. In this case, "Address is not assigned" is displayed in the upper right of the Home screen. Contact your network administrator.

"IP Address (LAN 1)": Enter the IP address of the unit.

"Subnet mask (LAN 1)": Enter the subnet mask.

"Default Gateway": Enter the IP address of the default gateway.

Note

- "IP Address (LAN 1)", "Subnet mask (LAN 1)", and "Default Gateway" can be entered only if "IP Address (LAN 1)" (setting) is set to "Manual".
- If the value for "IP Address (LAN 1)", "Subnet mask (LAN 1)", or "Default Gateway" contains 1 or 2 digits numbers, enter these numbers as they are. Do not enter like [.001].
Example: The IP address is [192.168.0.1].
– Correct entry: [192.168.0.1]
– Wrong entry: [192.168.000.001]

"DNS Server": Use [◀][▶] to select whether the IP address information for the DNS servers ("Primary DNS Server", "Secondary DNS Server") will be obtained automatically from a DHCP server or will be set manually.

- "Auto" (default): Obtain the IP address information automatically.
- "Manual": Set the IP address information manually.

Note

- To select "Auto", "IP Address (LAN 1)" (setting) must be set to "Auto".
- The DNS server must be set to use KX-VC Series NAT Traversal Service, to check for upgrades, and to download the latest software from the network.

"Primary DNS Server": Enter the IP address of the primary DNS server.

"Secondary DNS Server": Enter the IP address of the secondary DNS server.

Note

- "Primary DNS Server" and "Secondary DNS Server" can be entered only if "DNS Server" is set to "Manual".

Preparation

- If the value for "**Primary DNS Server**" or "**Secondary DNS Server**" contains 1 or 2 digits numbers, enter these numbers as they are. Do not enter like [.001].
Example: The IP address is [192.168.0.1].
 - Correct entry: [192.168.0.1]
 - Wrong entry: [192.168.000.001]

"LAN Mode (LAN 1)": Press [ENTER] and use [▲][▼] to select the LAN mode.

- **"1 Gbps (Auto)":** Negotiates with the other party to determine the LAN mode. The maximum setting is 1 Gbps (full duplex).
- **"1 Gbps (Fix)":** Fixes the LAN mode to 1 Gbps (full duplex).
- **"100 Mbps (Auto)"** (default): Negotiates with the other party to determine the LAN mode. The maximum setting is 100 Mbps (full duplex).
- **"100 Mbps (Fix)":** Fixes the LAN mode to 100 Mbps (full duplex).
- **"10 Mbps (Fix)":** Fixes the LAN mode to 10 Mbps (full duplex).

Note

- This setting is only displayed for the KX-VC2000.
- Match settings according to the hub or router to be connected.
- When **"10 Mbps (Fix)"** is set, set the **"Max. Bandwidth"** of **"Call set up"** to 10 Mbps or lower (Page 122).

16. Press [G].

17. Select **"Yes"** using [◀][▶], then press [ENTER].

- Settings become effective after the automatic restart.

Note

- If the IP address or subnet mask contains an invalid value, a message will appear requiring you to enter a valid IP address or subnet mask.
- A multicast address or broadcast address cannot be used for the IP address.
- If the unit is turned off and restarted before completing step 14, you must start again from step 1. If the unit is restarted after step 14 is completed, you can restart from step 15.

Making a Video Conference Call

You can make a video conference call using one of the following methods.

Note

- Make sure that peripheral devices (e.g., display, main video camera) are turned on.
- If a called party does not answer a video conference call within approximately 60 seconds, the call will be terminated automatically.
- Only 2-party video conference calls can be made using the incoming call history.
- The number of bars in the antenna icon will be 0 to indicate communication bandwidth that is lower than 256 kbps per site. In such cases, the image and voice quality may deteriorate.
- Video conference calls cannot be made if the call type programmed in the contact list (SIP or H.323) has been set to **"OFF"** on the call type settings screen.
- If a video conference call is made using a profile with an entry restriction, and you want to add a party to that call, you cannot call the party by entering an address directly or by using the call history.
- If a video conference call is received during another video conference call, a dialogue box is displayed to confirm whether to answer the incoming video conference call.

Use [◀][▶] to select **"Yes"** or **"No"** and press [ENTER].

- Select **"Yes"** to answer the video conference call.
- Select **"No"** to stop receiving the incoming video conference call and continue your current video conference call.

Calling Using One-Touch Connection Numbers From the Home Screen

Note

- To call using one-touch connection numbers, you need to set them in advance (Page 127).

- 1 Press [Home].
 - The Home screen is displayed.
- 2 With the dial keys, enter a One-Touch Connection number (1 to 5).
 - The information registered in the selected One-Touch Connection number is displayed.

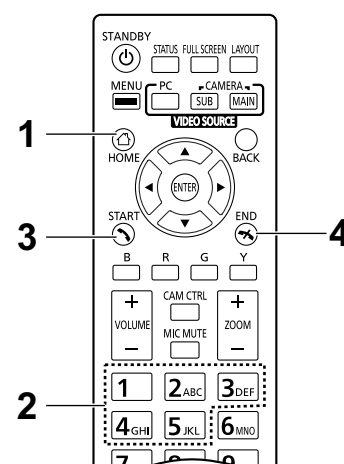
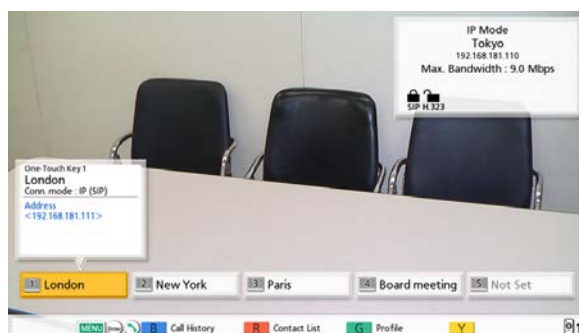

- 3 Press [START] to start the call.
 - You can also start the call pressing [ENTER].
- 4 When you want to end the call, press [END].
 - The Home screen is displayed.

Calling from the Contact List (2-party Conference)

Note

- To make a video conference call from the contact list, you must first register contacts in the contact list (Page 105).
- If "IP Address (LAN 1)" (setting) is set to "Auto" on the network settings screen (Page 118), or if "IPv6 Address (LAN 1)" (setting) is set to "Auto (SLAAC)" or "Auto (DHCP)" (Page 119), the unit's IP address will be automatically obtained, and therefore may change to a different IP address from the one registered in the other party's contact list. In such cases, when the other party tries to call you by selecting a registered IP address from their contact list, the call will not be connected. For details, contact your network administrator.

- 1 Press [MENU].
 - The Menu screen is displayed.
- 2 Select "Contact List" using [▲][▼] and press [ENTER].
 - The contact list screen is displayed. The entries are grouped in the index tabs and displayed in alphabetical order of "Site".

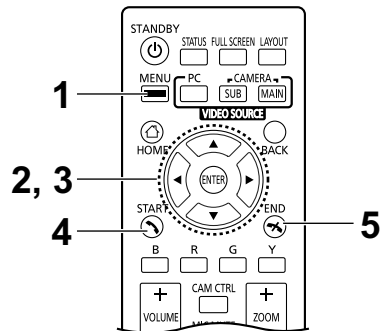
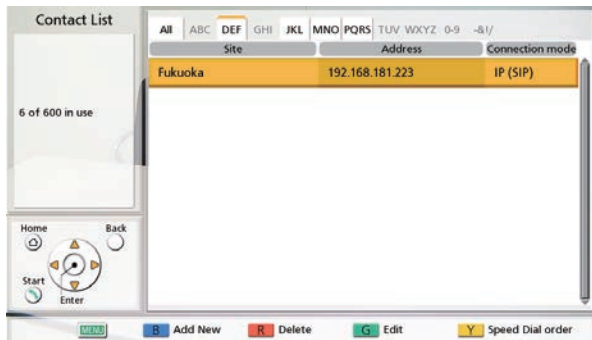

Note

- If you press [Y], entries are displayed in the speed dial number order.

- 3 Select the entry you want to call using [▲][▼].
- You can switch the index tab back and forth using [◀][▶]. (Index tabs in which no entries exist will be skipped.)
 - Press a numeric button on the remote control to switch to the index tab assigned to that button, as shown below.

Numeric button	Index Tab
1	–
2	ABC
3	DEF
4	GHI
5	JKL
6	MNO
7	PQRS
8	TUV
9	WXYZ
0	0-9
*	-&!/
#	–

Note

- If the display is sorted by speed dial number in step 2, you can click a speed dial number (1 through 600) to select it.
- 4 Press **[START]** to start the call.
- 5 When you want to end the call, press **[END]**.
- The Home screen is displayed.

Calling Using Profile (Multiple-party Video Conference Calls)

When making multiple-party video conference calls from the Menu screen, you can make a call using one of 20 profiles (1 to 20).

Note

- To use profiles with the KX-VC1000, you must use an activation key to enable 4 Point Built-in MCU support (Page 20).
- To call using a profile, you need to have a profile programmed in profile settings in advance (Page 108).

- 1 Press **[MENU]**.
 - The Menu screen is displayed.
- 2 Select **"Profile"** using **[▲][▼]** and press **[ENTER]**.
 - The profile list screen is displayed.

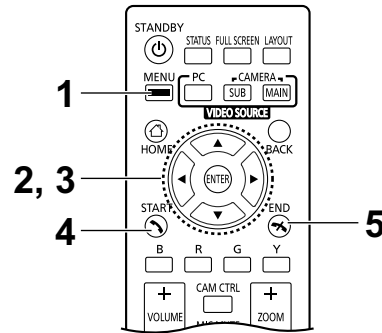
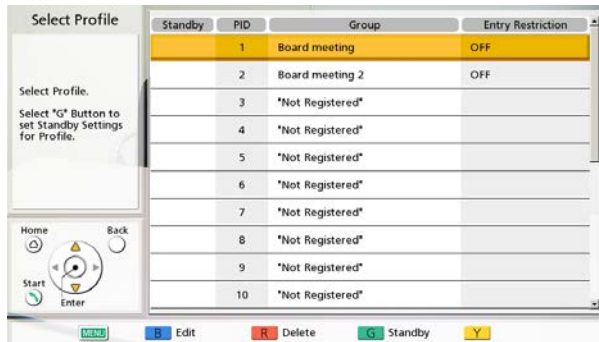

- 3 Select the profile you want to use to make a call using **[▲][▼]**.
- 4 Press **[START]** to start the call.
- 5 When you want to end the call, press **[END]**.
 - For ending a multiple-party video conference call, refer to "Disconnecting Parties During Video Conference Call (Page 69)".

Note

- You can make a video conference call by changing the party of the selected profile before starting the call by pressing **[START]**. Be aware that the selected connection destination will not be saved.

1. Press **[B]**.
 - The profile settings screen is displayed.
2. Select **"Site"** using **[▲][▼]**, then press **[ENTER]**.
 - The screen for selecting the party you want to call from the profile is displayed.
3. Select the party using **[▲][▼]**, then press **[ENTER]**.
 - Selecting an item will add or remove the "✓" mark for the item in the selection column. The contacts with a "✓" mark will be called.
4. Press **[START]** to start the call.
 - A dialogue box to confirm the start of a call is displayed.
5. Use **[◀][▶]** to select **"Yes"** and press **[ENTER]**.

Calling by Entering an Address Directly

When using IP mode, you can make a video conference call by entering the IP address (or host name), SIP URI (or SIP user name), H.323 extension, H.323 name, or MCU's conference room number@IP address. When using NAT Traversal mode, you can make a call by entering the connection number.

Note

- When using a KX-VC1000 that has not been expanded for 4 Point Built-in MCU support, one connection can be established, and **"Connection mode"**, **"Site"**, and **"Outgoing Bandwidth"** are displayed for **"Connection mode 1"**, **"Site 1"**, and **"Outgoing Bandwidth / Site"**.

- Press **[MENU]**.
 - The Menu screen is displayed.
- Select **"Manual Dial"** using **[▲]****[▼]** and press **[ENTER]**.
 - The manual dial screen is displayed. (The screen is from when using the KX-VC1600 (with standard features).)

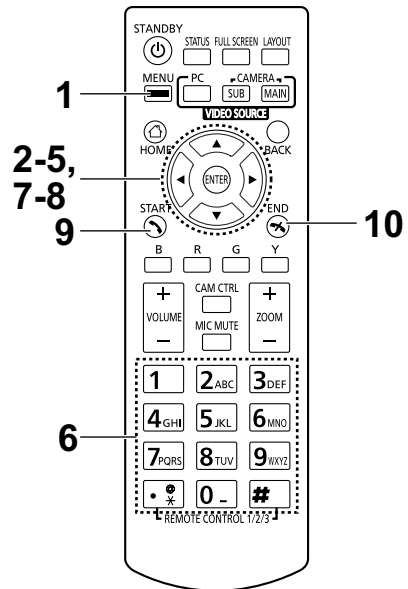
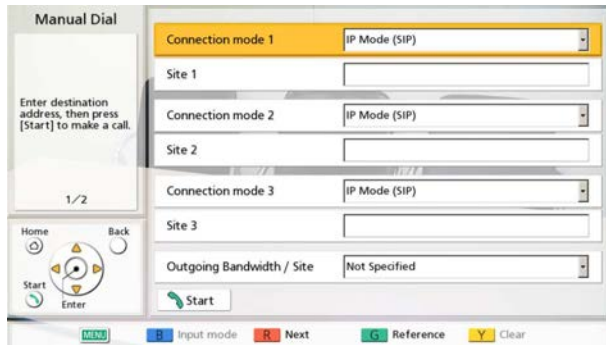

Note

- You can display the manual dial screen by pressing **[START]** in the Home screen instead of performing steps 1 and 2.
- Use **[▲]****[▼]** to select the connection mode you want to input (**"Connection mode 1"** to **"Connection mode 3"**) and press **[ENTER]**.
 - Use **[▲]****[▼]** to select the connection mode (**"IP Mode (SIP)"**, **"IP Mode (H.323)"**, **"NAT Traversal Mode"**).
 - Use **[▲]****[▼]** to select the site (**"Site 1"** to **"Site 3"**).
 - When using IP mode, enter the IP address (or host name), SIP URI (or SIP user name), H.323 extension, H.323 name, or MCU's conference room number@IP address. When using NAT Traversal mode, enter the connection number (7 digits).

Note

- When starting multiple-party video conference calls, repeat steps 3-6.
- When calling more than 4 parties, press **[R]** to display the next page.

- 7 Use [**▲**][**▼**] to select "**Outgoing Bandwidth / Site**" and press [**ENTER**] on the first page.
- 8 Use [**▲**][**▼**] to select the outgoing bandwidth/site to be used ("**Not Specified**", "**256 kbps**"–"**18 Mbps**"). (The default maximum selectable value: "**9.0 Mbps**")
- 9 Press [**START**] to start the call.
- 10 When you want to end the call, press [**END**].
 - The Home screen is displayed.

Note

- When using the KX-VC1300, you can have video conference calls with a maximum of 3 parties simultaneously. When you are using the KX-VC1600, the maximum is 5 simultaneous parties, and if you have the activation key (KX-VCS304) for enhanced features, you can make multiple-party video conference calls with a maximum of 9 parties. When you are using the KX-VC2000, the maximum is 15 simultaneous parties, and if you have the activation key (KX-VCS305) for enhanced features, you can make multiple-party video conference calls with a maximum of 19 or 23 parties.
- The KX-VC1000 can connect with one party. Using the KX-VCS314 activation key allows you to connect to up to 3 parties.
- If an IPv4 address contains 1 or 2 digit numbers, enter these numbers as they are. Do not enter like [.001].
Example: The IP address is [192.168.0.1].
 - Correct entry: [192.168.0.1]
 - Wrong entry: [192.168.000.001]
- For the IPv6 address input format, refer to Page 47.
- When making a call by specifying an IPv6 address port number, enclose the IPv6 address in square brackets.
(Input example) [2001:db8::10]:5060
- To initiate a video conference call by entering a SIP URI (SIP user name@SIP domain name), you must set "**SIP Server**" to "**ON**" and specify "**SIP Server Address**", "**SIP Username**", and "**SIP Domain Name**". Also, specify "**Digest Authentication**", "**Authentication ID**", and "**Authentication Password**" as necessary (Page 144). For details, contact your network administrator.
- When making a video conference call within your own SIP domain, you can make the call by entering the other party's SIP user name. When the other party is not within your SIP domain, you must also include their SIP domain name in addition to their SIP user name.
When a SIP domain name is not specified, your own SIP domain name is automatically appended to the address and the call is made. Be careful as this may result in calling the wrong party.
- See Page 47 for details about the characters that can be input for address entry.
Enter a standards-compliant value. For details, contact your network administrator.
- To initiate a video conference call by entering an MCU's conference room number@IP address, "**SIP Server**" and "**Gatekeeper**" must be set to "**OFF**" (Page 144, Page 145).
- If the other party is using the KX-VC300/KX-VC600 with a software version older than 3.00 (not including 3.00), you cannot make a video conference call using H.323. You must set "**SIP**" to "**ON**" on the call type settings screen (Page 143).
- Items that have been set to "**OFF**" on the call type settings screen (Page 143) cannot be set in the connection mode settings.
- You can refer to the contact list or call history when entering a destination by following the procedure below from the manual dial screen (you cannot enter a destination using the profile):

When using IP mode: the IP address (or host name), SIP URI (or SIP user name), H.323 extension, H.323 name, or MCU's conference room number@IP address

When using NAT Traversal mode: the connection number

1. Press **[G]**.
 - A dialogue box to select either the contact list or call history is displayed.
2. Use **[▲][▼]** to select the contact list or call history, and then press **[ENTER]**.
3. Use **[▲][▼]** to select the contact you want to refer to.
 - For the contact list, you can use **[◀][▶]** or the numeric buttons of the remote control to select the displayed tab (Page 53).
 - For the call history, press **[G]** to switch between the incoming call history and the outgoing call history.
4. Press **[ENTER]**.
 - When using H.323, you can also call by entering the other party's IP address (or host name) %H.323 extension (or H.323 name).
 - When the called party was selected from the contact list, the site name for the other party is displayed.
 - When the called party was selected from the call history, selecting a contact by their displayed site name in the history will display the site name for the other party.
 - For a party that is displaying a site name, the site name can be changed when inputting letters and numbers directly by pressing **[Y]** to delete the site name and then input it.

Calling from the Call History

You can make a video conference call from the call history. The call history is divided into outgoing and incoming calls. The last 100 video conference calls made and received are stored in the outgoing and incoming call history. Information such as the contact name, group name, address information¹, the date and time, the duration of the call, the result of the call, and the connection mode is displayed for each call on the outgoing call history screen and incoming call history screen. If the address of an entry in the call history is deleted from or edited in the contact list, the contact name in the call history entry will be replaced by the address information.

¹ Address information is as follows.

IP address/host name/SIP URI/H.323 extension/H.323 name/MCU's conference room number@IP address/MCU's SIP user name@IP address/connection number. (When using NAT Traversal mode, the connection number is displayed.)

Note

- If the other party uses the same SIP domain name as you, only the SIP user name, and not the SIP URI (SIP user name@SIP domain name) will be displayed in the call history.

Outgoing Call History:

- For video conference calls made using the contact list, the contact name is displayed. For video conference calls made by entering the IP address (or host name)/SIP URI/H.323 extension/H.323 name/MCU's conference room number@IP address/connection number directly (Page 56), that information is displayed instead of the contact name. (That information is displayed even if a matching entry exists in the contact list.)
- Even when a profile is used to make a video conference call, the call will appear in the outgoing call history. You can then make a video conference call with a profile from the outgoing call history.
- If consecutive video conference calls are made to the same destination, only the latest call will appear in the outgoing call history.

Incoming Call History:

- If the calling party's IP address/SIP URI/H.323 extension/H.323 name/MCU's conference room number@IP address/connection number is registered in the contact list, the contact name/group name is displayed. Otherwise, the IP address (or host name)/SIP URI/H.323 extension/H.323 name/MCU's conference room number@IP address/MCU's SIP user name@IP address/connection number is displayed.
- Depending on the type of MCU, a video conference call may be received from the MCU's SIP user name@IP address rather than the MCU's conference room number@IP address. In that case, you directly cannot call the MCU's conference room from this incoming call history.
- If consecutive unanswered video conference calls are received from the same party, only the latest call will appear in the incoming call history.
- When connecting to a non-Panasonic video conference system, you may not be able to initiate video conference calls with SIP URIs (or SIP user names)/H.323 extension/H.323 name in the incoming call history. In this case, contact your network administrator.

Starting a Video Conference

- 1 Press **[MENU]**.
 - The Menu screen is displayed.
- 2 Select **"Call History"** using **[▲]****[▼]** and press **[ENTER]**.
 - The outgoing call history screen is displayed.



Call history	Site	PID	Date and Time	Duration	Call result
100 most recent outgoing calls are recorded. Please select an entry and press [Start] to make a call.	London	-	13/JUL/2020 14:23	01:10:50	
	London	-	12/JUL/2020 14:21	01:10:23	
	London	-	09/JUL/2020 19:33	00:58:30	
	New York	-	08/JUL/2020 19:33	00:44:15	
	London	-	07/JUL/2020 15:30	00:55:20	
	Paris	-	07/JUL/2020 10:05	02:01:48	
	Paris	-	06/JUL/2020 12:23	01:00:01	
	Paris	-	01/JUL/2020 20:42	02:01:22	
	New York	-	01/JUN/2020 20:32	01:01:44	

Home Back
 Start Enter

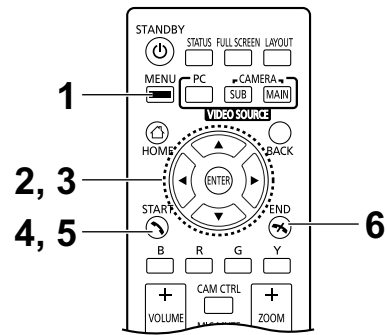
B Add as new **R** Delete **G** Incoming Call **Y** Delete All



Note

- When calling using a profile or when a call is received during Profile standby settings, the call is added to the outgoing and incoming call history between the parties, and a profile history showing the profile used is displayed. The Profile ID (PID) is displayed in the profile history and the individual outgoing and incoming call histories that used the profile. However, when using a KX-VC1000 that has not been expanded for 4 Point Built-in MCU support, the Profile ID (PID) column is not displayed.
- The result of the video conference call is displayed in the **"Call result"** column as follows:
 - : The video conference call was established.
 - : The video conference call was not established.
 - : The video conference call was made using multicasting or a profile was used.
- To move to the incoming call history screen, press **[G]**. You can switch between the outgoing call history screen and the incoming call history screen by pressing **[G]**.
- In the incoming call history, if a party is not registered in your contact list, the address information received from the party is displayed.
- In the outgoing call history, if a party is registered in your contact list, the contact name is displayed. However, when calling by entering an IP address (or host name), SIP URI (or SIP user name), H.323 extension, H.323 name, or MCU's conference room number@IP address/ connection number (Page 56), even if the party is registered in your contact list, the entered information is displayed instead of the contact name.
- When a contact in the incoming call history is newly added to your contact list, the incoming call history will be updated to display the contact's information from the contact list.
- When a party that is not registered in your contact list is selected, if you press **[B]**, the contact list registration screen will be displayed and a new contact can be registered (Page 107). Also, you may not be able to register a SIP URI (or SIP user name), H.323 extension, or H.323 name from the incoming call history to the contact list for reasons such as non-compliance with the relevant standards. In this case, contact your network administrator.

- 3 Select the party you want to call using [▲][▼].

Note

- If you press [ENTER], the call history details screen is displayed. (Not displayed when the profile history or multicast call history (outgoing) is selected.)

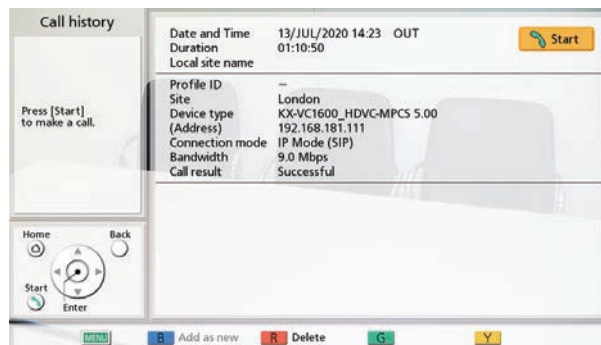

- When not selecting a local site (Page 113), the values of the basic settings are displayed for **"Local site name"**.
 - **"Bandwidth"** displays the mediated bandwidth for connected sites.
 - Depending on the other party, **"Device type"** may be blank.
 - When using a KX-VC1000 that has not been expanded for 4 Point Built-in MCU support, **"Profile ID"** is not displayed.
- 4 Press [START].
 - The manual dial screen is displayed. (Not displayed when the multicast history was selected.)

Note

- You can change the number of sites called or edit the other party's address.

- 5 Press [START] to start the call.
- 6 When you want to end the call, press [END].
 - The Home screen is displayed.

Answering a Video Conference Call

Depending on your setting, you can respond to a request to participate in a video conference call manually (manual answer), automatically (automatic answer), or forcibly (forced answer) (Page 121).

Note

- Make sure that peripheral devices (e.g., display, main video camera) are turned on.
- For sites operating as "Sub Sites" in multiple-party video conference calls using the Main Site's built-in MCU, for each Sub Site, set **"More than one incoming call"** to **"OFF"** in **"Call set up"**. With this setting, calls cannot be received during a video conference call.

When Manual Answer is Set

When a video conference call is incoming there will be an incoming call ring, and a dialogue box is displayed.



When the caller is registered in the contact list, the caller's site is displayed.

When the caller is not registered, the caller's IP address, connection number or other caller information that is received is displayed.

Note

- If the other party uses the same SIP domain name as you, only the SIP user name, and not the SIP URI (SIP user name@SIP domain name) is displayed.
- If the caller's group/site name, host name, SIP URI (or SIP user name), H.323 extension, or H.323 name is too long to display, it will be shortened and ended with "...".

Operation

- 1 Press **[START]**.
 - The video conference begins.
 - You can also answer the video conference call by pressing **[ENTER]**.

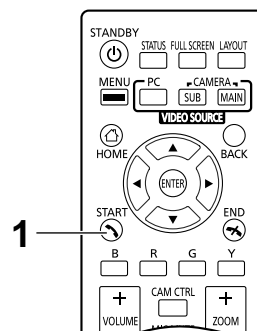

Note

- If you do not answer a video conference call within approximately 60 seconds, the call will be terminated automatically.
- If a video conference call is received while making a video conference call, a dialogue box to confirm if you answer a video conference call is displayed (only when **"More than one incoming call"** is set to **"ON"** in **"Call set up"**).
Use [**◀**][**▶**] to select **"Yes"** or **"No"** and press [**ENTER**].
 - When **"Yes"** is selected, you can answer a video conference call.
 - When **"No"** is selected, you can stop receiving a video conference call and continue making a video conference call.

When Automatic Answer is Set

When a video conference call is incoming while the Home screen is displayed, the call will be automatically answered after one ring, and transmission then begins. When a video conference call is incoming with a screen other than the Home screen displayed, a dialogue box is displayed, and the incoming calling continues.

Forced Answering

When a video conference call is incoming, the call is automatically answered regardless of existing calls or while idle, and transmission then begins.

Connecting to an MCU

Connecting to an MCU allows you to have a video conference call with 25 or more parties.

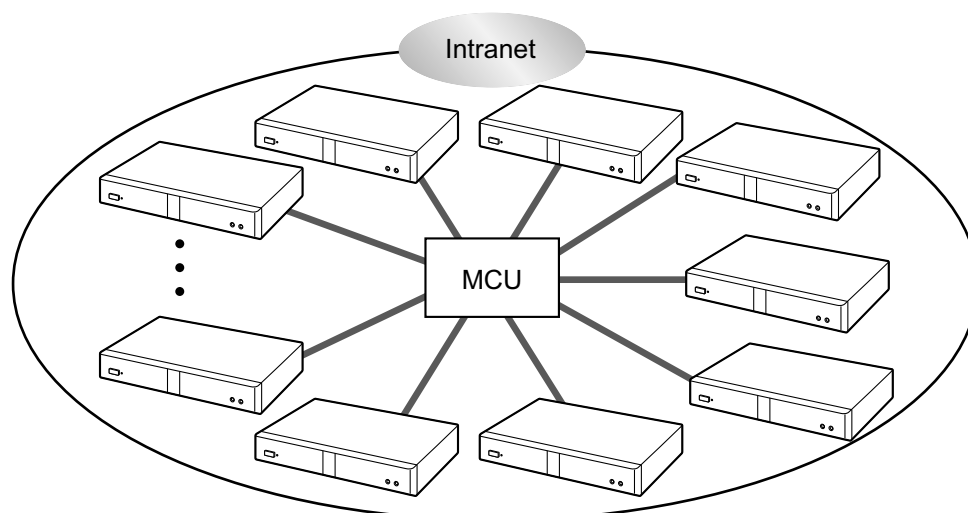

Note

- MCUs you want to connect to must meet the following criteria. Confirm the settings of the MCU.
 - Supports SIP or H.323 communication
 - Supports communication with the H.264 Baseline Profile and H.264 High Profile
 - Supports communication with the G.711, G.722, G.722.1, and G.722.1 Annex C voice codecs
- For details about the types of MCUs you can connect to, contact your dealer.
- Video conference calls to an MCU through a SIP server using a SIP URI are not guaranteed. IP addresses must be specified to make calls.
- The connection specifications (e.g., resolution) and available functions (e.g., content sharing) differ depending on the MCU you connect to. For details, contact your dealer.
- The procedure for connecting to an MCU differs depending on the MCU. For details, contact your dealer.
- Audio sent to the other party is monaural.
- While you are displaying a sub video camera's image, you cannot send a still image from the sub video camera.
- Encrypted communication may not be supported. In such cases, connect to an MCU over an intranet or via a VPN. For details, contact your dealer.
- For connection to an MCU, the smallest bandwidth value from among the following settings is applied. Depending on the network conditions, you must specify an appropriate bandwidth setting.
 - **"Max. Bandwidth"** (Page 122) in **"Call set up"**
 - **"Max. Bandwidth Per Site (LAN 1)"/"Max. Bandwidth Per Site (LAN 2)"** (Page 122, Page 122) in **"Call set up"**
 - **"Max. Bandwidth"** registered in the contact list (Page 105)
 - **"Outgoing Bandwidth / Site"** when the contact is directly input and a call is made (Page 57)

Operating an MCU Remotely using Tone Signals

When connecting to an MCU, you can send tone signals by pressing buttons (0–9, #, or ✕) on the remote control. Doing so allows you to operate (e.g., change the screen layout) the MCU remotely.

Note

- Features and operations that can be performed remotely will vary depending on the MCU.
- If the MCU you are connecting to does not support tone signals, an error message is displayed.
- If the other party sends tone signals to you, sound may be interrupted or a ringing noise may occur.
- You can operate the other party's device using tone signals with the KX-VC2000/KX-VC1600/KX-VC1300/KX-VC1000/HDVC-MPCS.

- 1 Enter a tone signal (0–9, #, or ✕).
 - The input field (1) is displayed.

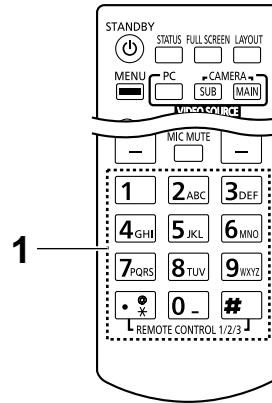

Note

- The input field can only contain up to 16 characters. If you input 17 characters, the first character input will not be displayed in the input field but all tone signals will be sent.
- The input field is not displayed until a tone signal is entered.
- If a tone signal is not entered for about 3 seconds, the input field disappears.
- If you enter further tone signals after the input field has disappeared, the tone signals entered the previous time are also displayed.

Adding Parties to an Existing Video Conference Call (Except Sub Sites)

A site in a 2-party video conference call or the Main Site can use the following operations to add parties to an existing call.

Note

- When using a KX-VC1000 that has not been expanded for 4 Point Built-in MCU support, **"Make a call"** is not displayed and you cannot connect to another party during a video conference.

- Press **[MENU]**.
 - The communication menu screen is displayed.
- Use **[▲][▼][◀][▶]** to select **"Make a call"** and press **[ENTER]**.
 - A dialogue box to select a dialling method is displayed.



Note

- For sites that are in a video conference call that was made using methods other than profile calling, the dialogue box is not displayed, and the manual dial screen is displayed instead.
- For sites that are in a video conference call that was made using profile calling with entry restriction set to **"ON"** in the profile settings, the dialogue box is not displayed, and the profile used to make the call is selected.

- Use **[▲][▼]** to select the dialling method (**"Profile"** or **"Manual Dial"**).

When selecting profile:

- The site selection screen is displayed.

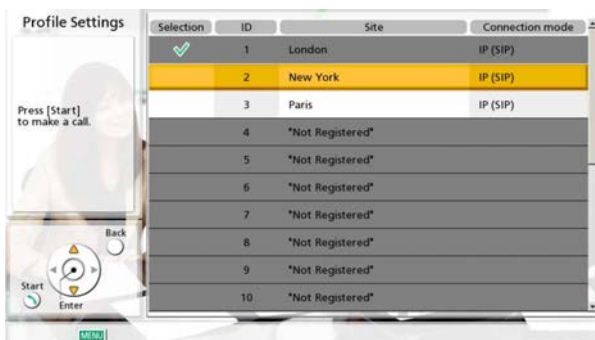

- Select the site that you want to add using **[▲][▼]** and press **[ENTER]**.
 - "✓" is displayed in the selection field.

When selecting manual dial:

- The manual dial screen is displayed. (The screen is from when using the KX-VC1600 (with standard features).)

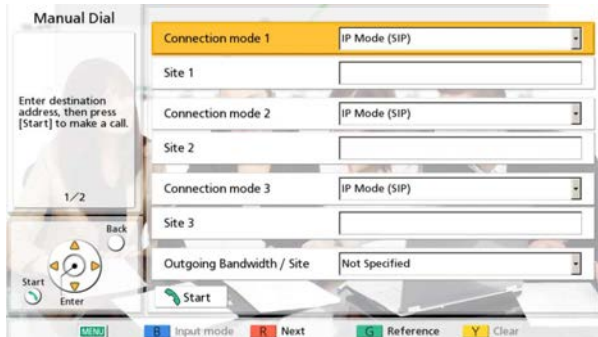

1. Program the information of the other party whom you want to add using [▲][▼].

Note

- You can refer to the contact list or call history when entering the other party's information.
 - ① Press [G].
 - A dialogue box to select either the contact list or call history is displayed.
 - ② Use [▲][▼] to select the contact list or call history, and then press [ENTER].
 - ③ Use [▲][▼] to select the contact you want to refer to.
 - For the contact list, you can use [◀][▶] or the numeric buttons of the remote control to select the displayed tab (Page 53).
 - For the call history, press [G] to switch between the incoming call history and the outgoing call history.
 - ④ Press [ENTER].

4. Press [START].

Note

- If your own site becomes a Sub Site, do not try to add additional sites to a video conference call.
- When the called party was selected from the contact list, the site name for the other party is displayed.
- When the called party was selected from the call history, selecting a contact by their displayed site name in the history will display the site name for the other party.
- For a party that is displaying a site name, the site name can be changed when inputting letters and numbers directly by pressing [Y] to delete the site name and then enter it.

Disconnecting Parties During Video Conference Call

You can disconnect parties during a video conference call.

Disconnecting a 2-party conference

1. Press **[END]**.
 - The video conference call is disconnected.

Disconnecting a multi-party conference (Main Site only)

1. Press **[END]**.
 - A dialogue box to select the party you want to disconnect is displayed. (The screen is from when using the KX-VC1600 (with standard features).)

Note

- In step 1, pressing **[MENU]**, using **[▲][▼][◀][▶]** to select "**Disconnect**", and then pressing **[ENTER]** will still display the dialogue box.

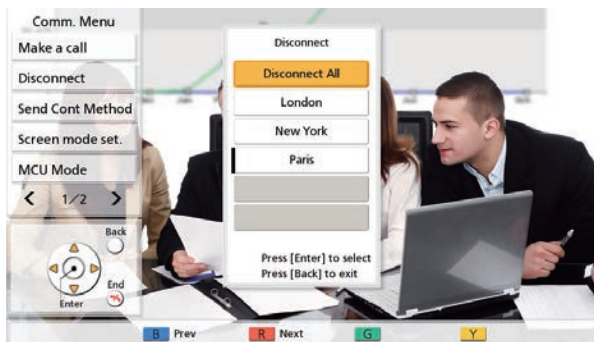

2. Select the party whom you want to disconnect using **[▲][▼][◀][▶]** and press **[ENTER]**.
 - The selected party is disconnected.

Disconnecting a multi-party conference (Sub Site only)

1. Press **[END]**.
 - The video conference call is disconnected.

Changing the Contents Sharing Method During Communication

The method for sending contents during communication can be changed.

Note

- The method for sending contents cannot be changed while contents are being sent.
1. Press **[MENU]**.
 - The communication menu screen is displayed.
 2. Use **[▲][▼][◀][▶]** to select "**Send Cont Method**", and press **[ENTER]**.
 - A dialogue box for selecting the contents sending method is displayed.

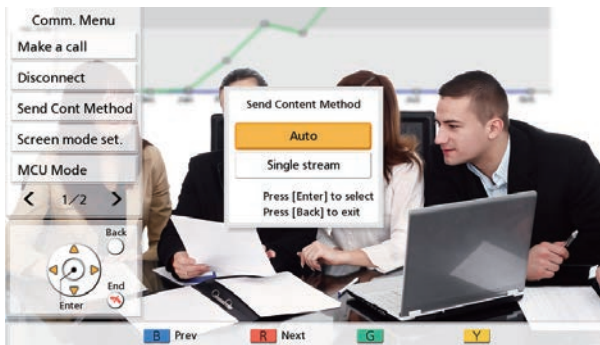

3. Use **[▲][▼]** to select a content sending method, and press **[ENTER]**.
 - "**Auto**" (default): Automatically changes between dual stream and single stream.
 - "**Single stream**": Fixed to single stream.

Changing the Screen Layout during a Video Conference Call

You can change the layout of the screen during a video conference call.

Note

- Display patterns differ depending on the number of displays, the number of parties, whether to share contents or not, whether it is Main Site or Sub Site, and whether the communication is single stream or dual stream.
- The default screen layout during a video conference call can be changed by the settings of "**Default Screen Layout**" of "**Video Output**" (Page 150).

1 Press [LAYOUT].

- The screen will cycle through the available layouts each time you press [LAYOUT].
 - **Layout 1:** The other party's image is displayed full screen.
 - **Layout 2:** The other party's image is displayed full screen, and your own image is displayed in the upper right subscreen (PwithP).
 - **Layout 3:** The other party's image and your own image are displayed (Side by side).
 - **Layout 4:** Your own image is displayed full screen.

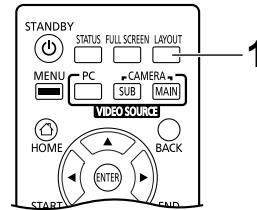

Example: 1 display, 2-party video conference, without content sharing, Main Site, Single stream communication

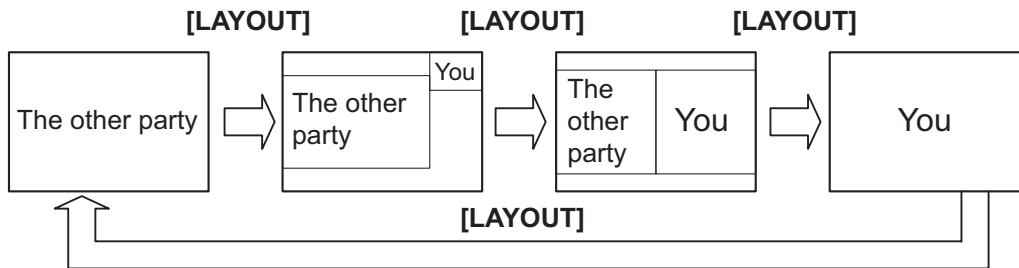

Changing the Other Party's Screen Display Layout

During a video conference call, you can change the other party's screen display layout. The numbers in the layout configurations indicate each site's image display priority. (Hereafter, the display with priority 1 will be described as the "main display".)

Note

- When using a KX-VC1000 that has not been expanded for 4 Point Built-in MCU support, "Screen mode set." is not displayed in the communication menu.

Main Site operations

1. Press [MENU].
 - The communication menu screen is displayed.
2. Use [▲][▼][◀][▶] to "Screen mode set." and press [ENTER].
 - The layout settings dialogue box is displayed.

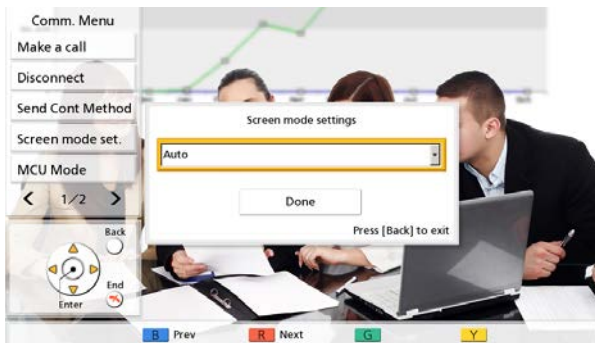

3. Press [ENTER], use [▲][▼] to select a layout to set, and then press [ENTER].
 - "Auto": Automatically changes the layout depending on the number of parties joining a video conference call and the MCU mode (Page 77, Page 108, Page 124).
 - "CP1" to "CP28": Changes to the selected layout.
4. Use [▲][▼] to select "Done" and press [ENTER].

Layout according to the number of sites when "Auto" is selected (Discussion Mode)

Number of Sites	Layout Number
2	CP1
3-4	CP4
5-6	CP6
7-8	CP8
9	CP9
10	CP10
11-13	CP13
14-15	CP15
16	CP16
17-20	CP20

Number of Sites	Layout Number
21	CP21
22-24	CP24

Layout according to the number of sites when "Auto" is selected (Presentation Mode)

Number of Sites	Layout Number
2	CP1
3	CP2
4-5	CP4
6-7	CP6
8-9	CP8
10	CP9
11	CP10
12-14	CP13
15-16	CP15
17	CP16
18-21	CP20
22	CP21
23-24	CP24

Layout patterns that can be selected during a video conference call

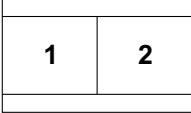
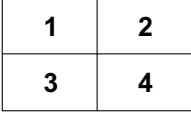
Layout Number	Layout Configuration
CP1	
CP2	
CP4	

Layout Number	Layout Configuration																																			
CP6	<table border="1"> <tr> <td colspan="2">1</td> <td>2</td> </tr> <tr> <td colspan="2"></td> <td>3</td> </tr> <tr> <td>4</td> <td>5</td> <td>6</td> </tr> </table>	1		2			3	4	5	6																										
1		2																																		
		3																																		
4	5	6																																		
CP8	<table border="1"> <tr> <td colspan="3">1</td> <td>2</td> </tr> <tr> <td colspan="3"></td> <td>3</td> </tr> <tr> <td colspan="3"></td> <td>4</td> </tr> <tr> <td>5</td> <td>6</td> <td>7</td> <td>8</td> </tr> </table>	1			2				3				4	5	6	7	8																			
1			2																																	
			3																																	
			4																																	
5	6	7	8																																	
CP9	<table border="1"> <tr> <td>1</td> <td>2</td> <td>3</td> </tr> <tr> <td>4</td> <td>5</td> <td>6</td> </tr> <tr> <td>7</td> <td>8</td> <td>9</td> </tr> </table>	1	2	3	4	5	6	7	8	9																										
1	2	3																																		
4	5	6																																		
7	8	9																																		
CP10	<table border="1"> <tr> <td colspan="2">1</td> <td colspan="2">2</td> </tr> <tr> <td>3</td> <td>4</td> <td>5</td> <td>6</td> </tr> <tr> <td>7</td> <td>8</td> <td>9</td> <td>10</td> </tr> </table>	1		2		3	4	5	6	7	8	9	10																							
1		2																																		
3	4	5	6																																	
7	8	9	10																																	
CP13	<table border="1"> <tr> <td colspan="2">1</td> <td>2</td> <td>3</td> </tr> <tr> <td colspan="2"></td> <td>4</td> <td>5</td> </tr> <tr> <td>6</td> <td>7</td> <td>8</td> <td>9</td> </tr> <tr> <td>10</td> <td>11</td> <td>12</td> <td>13</td> </tr> </table>	1		2	3			4	5	6	7	8	9	10	11	12	13																			
1		2	3																																	
		4	5																																	
6	7	8	9																																	
10	11	12	13																																	
CP15	<table border="1"> <tr> <td colspan="3">1</td> <td colspan="2">2</td> </tr> <tr> <td colspan="3"></td> <td colspan="2">3</td> </tr> <tr> <td>4</td> <td>5</td> <td>6</td> <td>7</td> <td>8</td> </tr> <tr> <td>9</td> <td>10</td> <td>11</td> <td>12</td> <td>13</td> </tr> <tr> <td>14</td> <td>15</td> <td>16</td> <td>17</td> <td>18</td> </tr> </table>	1			2					3		4	5	6	7	8	9	10	11	12	13	14	15	16	17	18										
1			2																																	
			3																																	
4	5	6	7	8																																
9	10	11	12	13																																
14	15	16	17	18																																
CP16	<table border="1"> <tr> <td>1</td> <td>2</td> <td>3</td> <td>4</td> </tr> <tr> <td>5</td> <td>6</td> <td>7</td> <td>8</td> </tr> <tr> <td>9</td> <td>10</td> <td>11</td> <td>12</td> </tr> <tr> <td>13</td> <td>14</td> <td>15</td> <td>16</td> </tr> </table>	1	2	3	4	5	6	7	8	9	10	11	12	13	14	15	16																			
1	2	3	4																																	
5	6	7	8																																	
9	10	11	12																																	
13	14	15	16																																	
CP20	<table border="1"> <tr> <td colspan="2">1</td> <td colspan="2">2</td> </tr> <tr> <td>3</td> <td>4</td> <td>5</td> <td>6</td> </tr> <tr> <td>7</td> <td>8</td> <td>9</td> <td>10</td> </tr> <tr> <td>11</td> <td>12</td> <td>13</td> <td>14</td> </tr> <tr> <td>15</td> <td>16</td> <td>17</td> <td>18</td> </tr> <tr> <td>19</td> <td>20</td> <td>21</td> <td>22</td> </tr> </table>	1		2		3	4	5	6	7	8	9	10	11	12	13	14	15	16	17	18	19	20	21	22											
1		2																																		
3	4	5	6																																	
7	8	9	10																																	
11	12	13	14																																	
15	16	17	18																																	
19	20	21	22																																	
CP21	<table border="1"> <tr> <td colspan="3">1</td> <td>2</td> <td>3</td> </tr> <tr> <td colspan="3"></td> <td>4</td> <td>5</td> </tr> <tr> <td colspan="3"></td> <td>6</td> <td>7</td> </tr> <tr> <td colspan="3"></td> <td>8</td> <td>9</td> </tr> <tr> <td>10</td> <td>11</td> <td>12</td> <td>13</td> <td>14</td> </tr> <tr> <td>15</td> <td>16</td> <td>17</td> <td>18</td> <td>19</td> </tr> <tr> <td>20</td> <td>21</td> <td>22</td> <td>23</td> <td>24</td> </tr> </table>	1			2	3				4	5				6	7				8	9	10	11	12	13	14	15	16	17	18	19	20	21	22	23	24
1			2	3																																
			4	5																																
			6	7																																
			8	9																																
10	11	12	13	14																																
15	16	17	18	19																																
20	21	22	23	24																																

Layout Number	Layout Configuration																																			
CP24	<table border="1"> <tr><td>1</td><td>2</td><td>5</td><td>6</td></tr> <tr><td></td><td></td><td>7</td><td>8</td></tr> <tr><td>3</td><td>4</td><td>9</td><td>10</td></tr> <tr><td></td><td></td><td>11</td><td>12</td></tr> <tr><td>13</td><td>14</td><td>15</td><td>16</td></tr> <tr><td>17</td><td>18</td><td>19</td><td>20</td></tr> <tr><td>21</td><td>22</td><td>23</td><td>24</td></tr> </table>	1	2	5	6			7	8	3	4	9	10			11	12	13	14	15	16	17	18	19	20	21	22	23	24							
1	2	5	6																																	
		7	8																																	
3	4	9	10																																	
		11	12																																	
13	14	15	16																																	
17	18	19	20																																	
21	22	23	24																																	
CP25	<table border="1"> <tr><td>1</td><td>2</td><td>3</td><td>4</td><td>5</td></tr> <tr><td>6</td><td>7</td><td>8</td><td>9</td><td>10</td></tr> <tr><td>11</td><td>12</td><td>13</td><td>14</td><td>15</td></tr> <tr><td>16</td><td>17</td><td>18</td><td>19</td><td>20</td></tr> <tr><td>21</td><td>22</td><td>23</td><td>24</td><td>25</td></tr> </table>	1	2	3	4	5	6	7	8	9	10	11	12	13	14	15	16	17	18	19	20	21	22	23	24	25										
1	2	3	4	5																																
6	7	8	9	10																																
11	12	13	14	15																																
16	17	18	19	20																																
21	22	23	24	25																																
CP28	<table border="1"> <tr><td></td><td></td><td>2</td><td>3</td><td>4</td></tr> <tr><td></td><td></td><td>5</td><td>6</td><td>7</td></tr> <tr><td></td><td>1</td><td>8</td><td>9</td><td>10</td></tr> <tr><td>11</td><td>12</td><td>13</td><td>14</td><td>15</td></tr> <tr><td>16</td><td>17</td><td>18</td><td>19</td><td>20</td></tr> <tr><td>21</td><td>22</td><td>23</td><td>24</td><td>25</td></tr> <tr><td>26</td><td>27</td><td>28</td><td>29</td><td>30</td></tr> </table>			2	3	4			5	6	7		1	8	9	10	11	12	13	14	15	16	17	18	19	20	21	22	23	24	25	26	27	28	29	30
		2	3	4																																
		5	6	7																																
	1	8	9	10																																
11	12	13	14	15																																
16	17	18	19	20																																
21	22	23	24	25																																
26	27	28	29	30																																

Operation of Sub Sites

During a video conference call, you can use remote control operations to change the screen display layout from a Sub Site.

Remote Control Operation and Layout for Sub Sites

Numerical Keypad	Layout Number
*21	CP1
*22	CP2
*24	CP4
*26	CP6
*28	CP8
*29	CP9
*20	CP10
*30	CP10
*33	CP13
*35	CP15
*36	CP16
*40	CP20
*41	CP21
*44	CP24
*45	CP25
*48	CP28

Note

- By using *#4 or *#6 you can switch to lower or higher layout numbers. *#4 switches to a lower order layout and *#6 switches to a higher order layout.
- If **"DTMF layout change"** in **"MCU Settings"** is set to **"OFF"**, operations cannot be performed from a Sub Site (Page 126).
- When the layout is changed from a Sub Site, all sites' layouts are also changed.
- When the layout of the Main Site automatically changes (when **"Screen Layout"** of **"MCU Settings"** is set to **"Auto"** [Page 124], or when **"Screen mode set."** is set to **"Auto"** on the communication menu screen [Page 72]), operations cannot be made from a Sub Site.

Changing the MCU Mode (Main Site Only)

You can change the MCU mode during a video conference call.

Note

- When using a KX-VC1000 that has not been expanded for 4 Point Built-in MCU support, "**MCU Mode**" is not displayed in the communication menu.

- Press **[MENU]**.
 - The communication menu screen is displayed.
- Use **[▲][▼][◀][▶]** to select "**MCU Mode**" and press **[ENTER]**.
 - The MCU mode settings dialogue box is displayed.



- Use **[▲][▼]** to select the MCU mode.
 - "Discussion"**: The same image is displayed for the main site and sub sites. This mode is suited to discussion-style conferences.
 - "Presentation"**: The main site sees a composite image including the sub sites, and the sub sites see the image from the main site only. This mode is suited to lecture-style conferences.

Note

- When **"Y Button during MCU"** in **"GUI Settings"** is set to **"Discussion / Presentation"**, you can switch the MCU mode by pressing **[Y]** (Page 154).

Changing the Setting of the Main Display (Main Site only)

The settings of the site displayed as the main site during a call can be changed.

Note

- When using a KX-VC1000 that has not been expanded for 4 Point Built-in MCU support, **"Main Position set."** is not displayed in the communication menu.

1. Press **[MENU]**.
 - The communication menu screen is displayed.
2. Use **[▲][▼][◀][▶]** to select **"Main Position set."** and press **[ENTER]**.
 - The main display settings dialogue box that corresponds to the MCU mode (Page 77, Page 108, Page 124) is displayed.

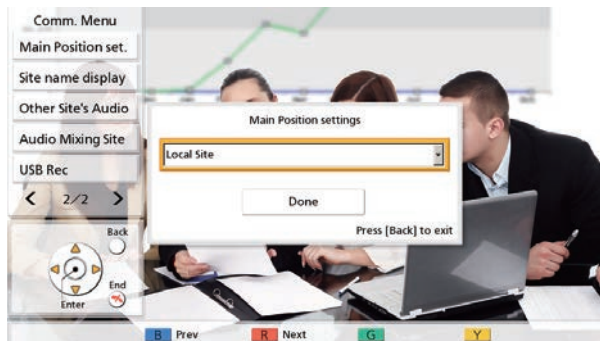

3. Press **[ENTER]** and use **[▲][▼]** to select a switching method and then press **[ENTER]**.

When using Discussion Mode

 - **"Local Site"**: Displays your own site.
 - **"Voice Activation 1"**: The party (caller) with the loudest volume during a call will be automatically set as the main display.
 - **"Voice Activation 2 (Local Site)"**: Your own site's image is fixed as the main display, and the party (caller) with the loudest volume during a call will be set to display priority 2.
 - **"Voice Activation 2 (Site 1)" to "Voice Activation 2 (Site 23)"**: The selected site is displayed as the main display, and the site with the loudest volume at the time is displayed as display priority 2.
 - **"Site 1" to "Site 23"**: Displays the selected site as the main display.
 - **"Specified Position"**: Displays each site's image in the specified position.

When using Presentation Mode

 - **"Site 1" to "Site 23"**: Displays the selected site as the main display.
 - **"Specified Position"**: Displays each sub site's image in the specified position.

Note

- **"Specified Position"** can only be selected when registering a profile (you can select any item other than **"Specified Position"** while on a video conference call, but you cannot select **"Specified Position"** again). For information about the displayed position when **"Specified Position"** is selected, refer to the section about profile registration (Page 109, Page 109).
- In the following situations, the current setting is displayed as **"Voice Activation 2 (-)"**. You can also select the switching method.
 - When a site has disconnected after you set **"Voice Activation 2 (Site 1)" to "Voice Activation 2 (Site 23)"**.

- When **"Main Position (Discussion)"** is set to **"Voice Activation 2 (Site 1)"** to **"Voice Activation 2 (Site 30)"** in the site's registration, and the selected site is not connected (Page 109).

4. Use [▲][▼] to select **"Done"** and press [ENTER].

Note

- When sharing content via single stream communication, the content will automatically displayed as the main display.

Changing the Site Name Display (Main Site only)

The setting of whether site names are displayed during a video conference call can be changed.

Note

- When using a KX-VC1000 that has not been expanded for 4 Point Built-in MCU support, "**Site name display**" is not displayed in the communication menu.
1. Press **[MENU]**.
 - The communication menu screen is displayed.
 2. Use **[▲][▼][◀][▶]** to select "**Site name display**" and press **[ENTER]**.
 - The site name display setting dialogue box is displayed.

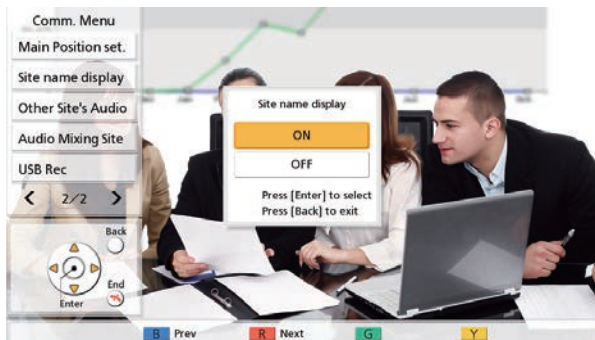

3. Use **[▲][▼]** to select whether to display a site name ("**ON**", "**OFF**"), and press **[ENTER]**.

Changing the Audio Settings for Other Parties (Main Site only)

During a video conference call, you can change the mode that is used to mix the audio from your own site and the other party's site.

Note

- When using a KX-VC1000 that has not been expanded for 4 Point Built-in MCU support, **"Other Site's Audio"** is not displayed in the communication menu.

- Press **[MENU]**.
 - The communication menu screen is displayed.
- Use **[▲][▼][◀][▶]** to select **"Other Site's Audio"** and press **[ENTER]**.
 - The other party's audio setting dialogue box is displayed.

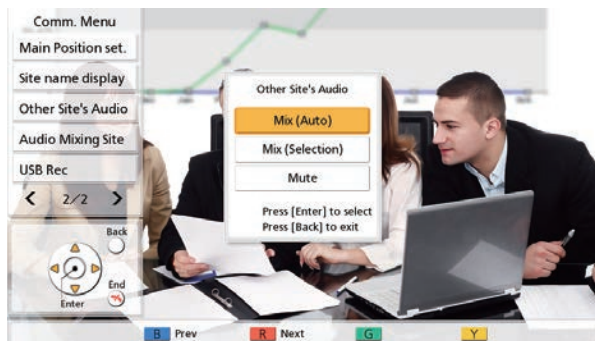

- Use **[▲][▼]** to select **"Mix (Auto)"**, **"Mix (Selection)"**, or **"Mute"** and press **[ENTER]**.
 - "Mix (Auto)"** (default): Audio from the loudest 4 sites is automatically mixed together.
 - "Mix (Selection)"**: The audio from the selected sites (up to 4) is mixed together.
 - "Mute"**: Mutes the audio of the other party. Only the audio of the Main Site is output.

Changing the Settings for Audio Mixing Sites (Main Site Only)

When "Other Site's Audio" is set to "Mix (Selection)", you can change the audio settings for sites whose audio is mixed together. (Page 81, Page 108)

Note

- When using a KX-VC1000 that has not been expanded for 4 Point Built-in MCU support, "Audio Mixing Site" is not displayed in the communication menu.
1. Press [MENU].
 - The communication menu screen is displayed.
 2. Use [▲][▼][◀][▶] to select "Audio Mixing Site" and press [ENTER].
 - Audio mixing site setting dialogue box is displayed.

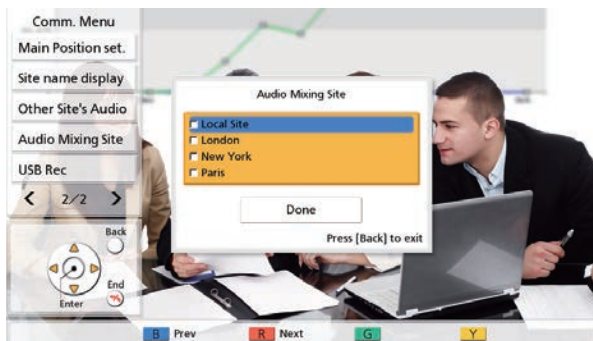

3. Use [▲][▼] to select the sites whose audio will be mixed together and press [ENTER].
 - Press [ENTER] to select/deselect the desired sites. You can select up to 4 sites.
4. Use [▲][▼] to select "Done" and press [ENTER].

Note

- This setting is only available when "Other Site's Audio" in the communication menu (Page 81) or "Other Site's Audio" in the profile setup (Page 108) is set to "Mix (Selection)".

Starting and Stopping Recording

You can start and stop recording during a video conference call. The recorded video and audio are saved on the USB memory device connected to the back of the unit.

Note

- For details about recording features, refer to "Using USB Recording Features (Page 183)".
 - You can also start and stop recording while idle (Page 132).
1. Press [MENU].
 - The communication menu screen is displayed.
 2. Use [▲][▼][◀][▶] to select "USB Rec" and press [ENTER].
 - The dialogue box to start or stop recording is displayed.
 3. Use [◀][▶] to select "Yes" or "No" and press [ENTER].

When not recording

 - Selecting "Yes" starts recording.
 - Selecting "No" does not start recording.

When recording

- Selecting **"Yes"** stops recording.
- Selecting **"No"** does not stop recording.

Note

If you set **"USB Rec"** to **"G" Button during call** in **"GUI Settings"**, you can start and stop recording during a call using **[G]** (Page 154).

Checking the Call History

The history of the connections with other sites from the start of the call to the present can be checked.

1. Press **[B]** during a video conference call.

- The call history screen is displayed.

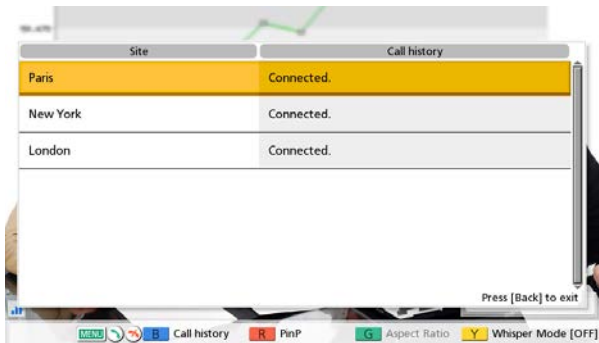

2. Press **[BACK]**.

- The display returns to the video conference call screen.

Note

- You can use **[▲]****[▼]** to scroll in the call history screen and display the previous or next history entry.
- If no operations are performed for approximately 10 seconds after the call history screen is displayed, the display returns to the video conference call screen.
- The call history of sites that the other party in the video conference call has connected to are not displayed.

Adjusting the Volume

You can adjust the volume during a video conference call.

- 1 Press **[VOLUME (+/-)]**.
 - The volume level bar is displayed at the bottom of the screen.
- 2 Adjust the volume using **[VOLUME (+/-)]**.
 - Pressing **[+]** will increase the volume of the other party's voice.
 - Pressing **[-]** will decrease the volume of the other party's voice.

After about 3 seconds, the volume level bar disappears.

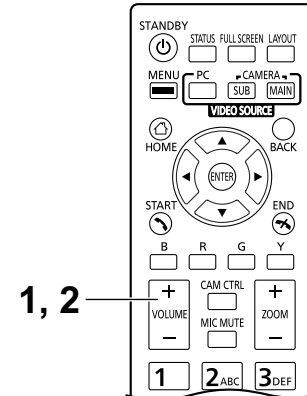

Note

- You can set the volume level of a video conference call before starting the call (Page 128).
- After ending a video conference call, the volume level returns to the volume level set before starting the call.
- You cannot adjust the display's volume.

Muting the Microphone

During a video conference call, you can mute the microphone so that your voice cannot be heard by the other party. You will be able to hear the other party's voice, but they will not be able to hear you.

Note

- You can set the microphone(s) to be mute at the start of a video conference call regardless of which party initiated the call (Page 122).

Muting the Microphone (Operation with the Remote Control)

- 1 Press **[MIC MUTE]**.
 - An icon appears in the status display area of the screen (Page 41), and the LED light on the Boundary Microphone becomes red. Make sure the colour of the LED changes.
 - Pressing **[MIC MUTE]** again will unmute the microphone. The LED light on the Boundary Microphone becomes green. Make sure the colour of the LED changes.

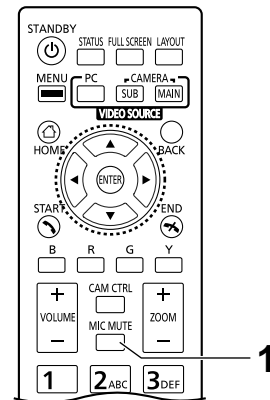

Muting the Microphone (Operation with the Boundary Microphone)

- 1 Press the MIC Mute button.
 - An icon appears in the status display area of the screen (Page 41), and the LED light on the Boundary Microphone becomes red. Make sure the colour of the LED changes.
 - Pressing the MIC Mute button again will unmute the microphone. The LED light on the Boundary Microphone becomes green. Make sure the colour of the LED changes.

Note

- When multiple Digital Boundary Microphones are connected, pressing the MIC Mute button of one Digital Boundary Microphone will mute all Digital Boundary Microphones.
- When using Digital Boundary Microphones and an Analogue Boundary Microphone together, pressing the MIC Mute button on one Boundary Microphone will mute all Boundary Microphones.
- If a headset is connected, the MIC Mute button on a Boundary Microphone will not work.

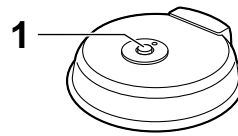

Digital Boundary Microphone

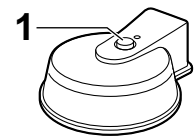

Analogue Boundary Microphone

Reducing Microphone Noise

You can reduce the amount of ambient noise picked up by the microphone (shuffling of papers, etc.) during a video conference call. When noise reduction is in effect, the volume level of voices may also be reduced.

1 Press [Y].

- "Whisper Mode [ON]" is displayed, and noise reduction is enabled.

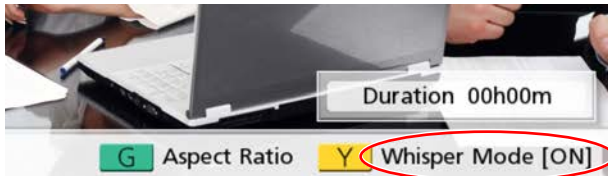

- Pressing [Y] again will display "Whisper Mode [OFF]", and noise reduction is disabled.

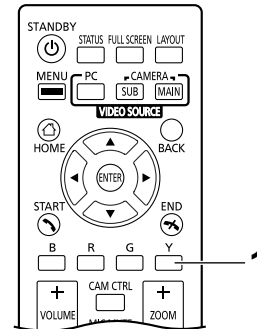
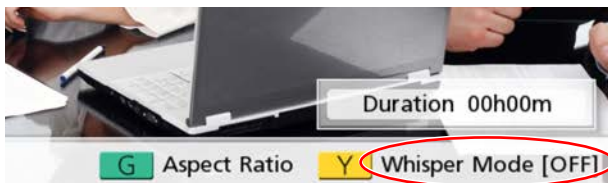

Note

- Noise reduction is available only when Digital Boundary Microphones are connected.
- You can set whether to enable noise reduction for a video conference call before starting the call (Page 123).
- After a video conference call is finished, the noise reduction setting returns to the value set before starting the call.
- When "'Y' Button during MCU" in "GUI Settings" is set to "Discussion / Presentation", you can switch the MCU mode by pressing the [Y] button during calls that use the MCU (except for KX-VC1000) (Page 154).
- This feature is disabled for KX-VC1000, and noise reduction is not displayed on the [Y] button in the shortcut key area. If the unit has been expanded for 4 Point Built-in MCU support, the option to change the MCU mode is assigned to the [Y] button during video conferences that use the MCU.

Displaying a Computer's Screen and the Sub Video Camera's Image

When a computer or sub video camera is connected to the unit, you can display the computer's screen or the sub video camera's image on your display and to other parties. This is convenient when explaining something on the computer's screen or the sub video camera's image while showing them to others, for example.

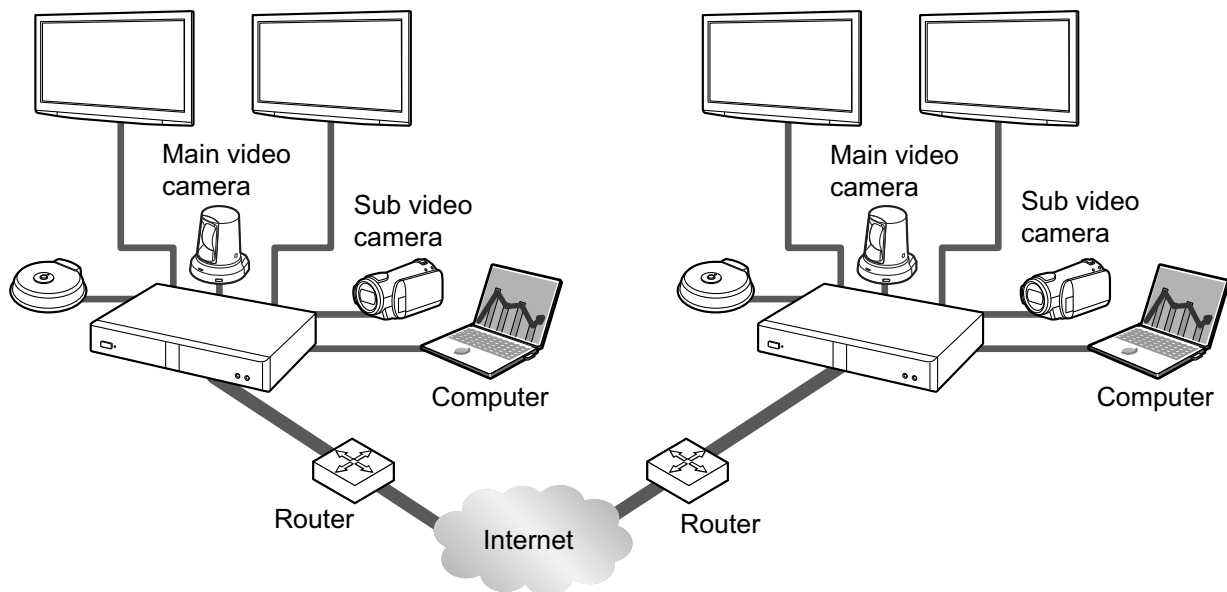

Note

- The computer screen resolutions supported by the unit are VGA (640 × 480), SVGA (800 × 600), XGA (1024 × 768), HD (1280 × 720), and WXGA (1280 × 768, 1280 × 800), SXGA (1280 × 1024), FWXGA (1360 × 768, 1366 × 768), WXGA+ (1440 × 900), WXGA++ (1600 × 900), UXGA (1600 × 1200), WSXGA+ (1680 × 1050), Full-HD (1920 × 1080).

1. Press **[PC]** or **[CAMERA SUB]** during a video conference call.

For dual stream communication:

- You can send the image of your video camera and the image of your computer's screen or a sub video camera at the same time to the other party. You can view the other party and check shared data at the same time.

Note

- If dual stream communication is disabled in the communication settings (Page 122), or if a device that does not support dual stream communication is connected, the screen switching method will be used.

When using the screen switching method (hereafter referred to as "single stream communication"):

- Switches the display from the image of the main video camera to that of the computer's screen or the image of the sub camera. The same image is also shown on the other party's display.

2. Press **[CAMERA MAIN]** to return to the image of the main video camera.

During Video Conference Calls

Example: single stream communication (2 screens used, 4-party video conference, at the Main Site)

Without contents sharing

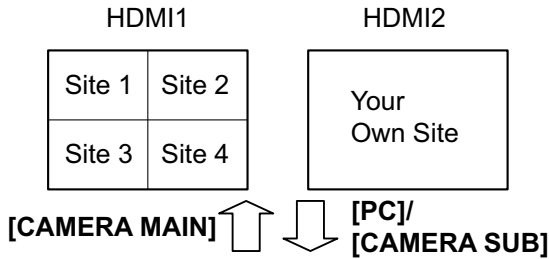

Example: dual stream communication (2 screens used, 4-party video conference, at the Main Site)

Without contents sharing

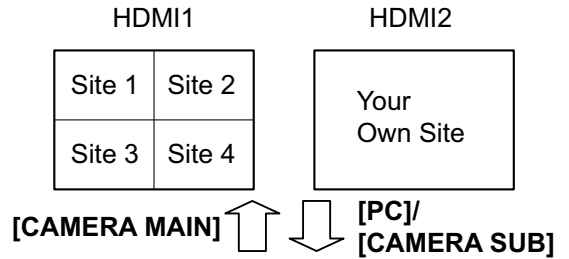

With contents sharing

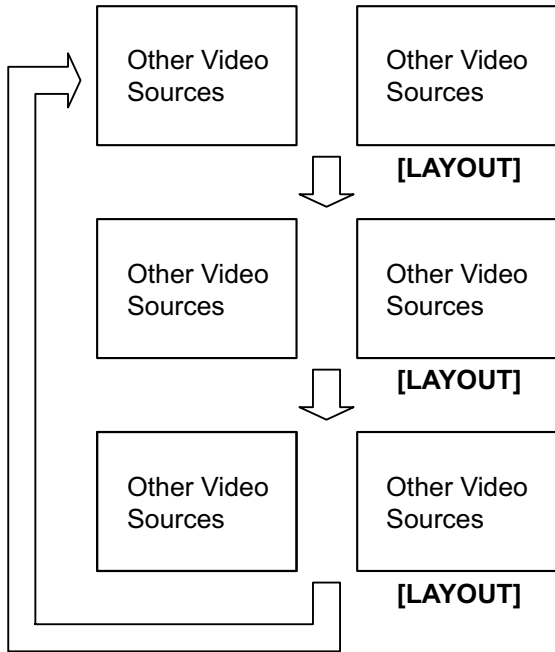

With contents sharing

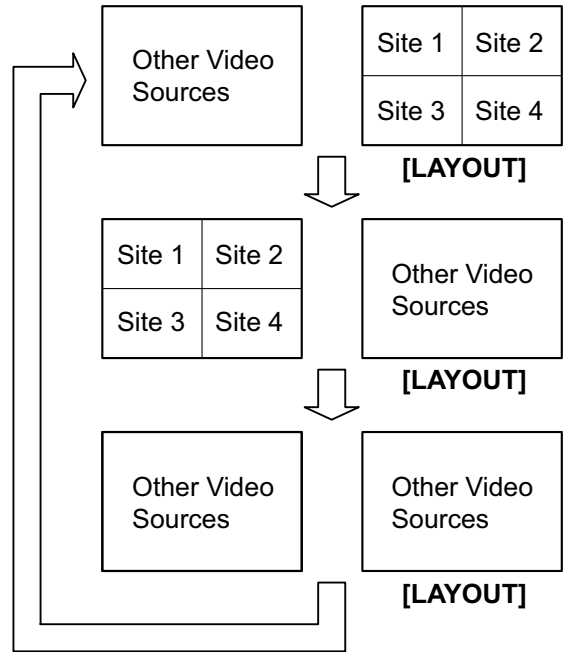

*Sites 1 through 4 are your own site or another party's site.

Note

- Pressing [**LAYOUT**] in succession will switch the displays of the 2 monitors in different combinations of the contents image display, the contents image combined with the camera image, and the camera image display.
- For single stream communication:
 - During a 2-party call, depending on the screen layout state of the other party, the display of the other party may not show the same screen as yours. In such cases, press [**CAMERA MAIN**] to cancel contents sharing, or instruct the other party to change their screen layout to one that displays your screen.
- For dual stream communication:
 - While sharing the contents of a computer's screen or the sub camera image, the other party can also share their contents. Note that in this case, the images for the contents of all sites will change to the last shared image.
- While the Home screen (idle screen) is displayed, pressing [**PC**] or [**CAMERA SUB**] will display the contents of the computer's screen or the sub camera's image. When displaying the computer's screen or the image of the sub camera, the system will not enter screen standby mode. To return to the Home screen, press [**CAMERA MAIN**].

Controlling a Video Camera

If a PTZ (pan, tilt, zoom) camera or a FIX camera is connected to your unit or the other party's unit, you can control the pan (side-to-side movement), the tilt (up-down movement), and the zoom of the video camera during a video conference call. You can perform this operation with the main video camera or a sub video camera.

Note

- In this manual, "PTZ camera" indicates a video camera whose moving parts will rotate when the direction of the video camera is changed. "FIX camera" indicates a video camera that has no moving parts and does not rotate.
- For details about compatible video camera models, contact your dealer.
- The features that can be used may be limited depending on your video camera model. (e.g., A video camera with only a zoom feature)
- When the other party is using a non-Panasonic video conference system, some operations may not be available, or unintended operations may occur.
- The setting "**Direct Cam Ctrl on Home Screen**" can be used to disable the operation of idle video cameras (Page 131).
- If any of the other parties is using the KX-VC500/KX-VC300/KX-VC600 with a software version older than 2.30 (not including 2.30), you will not be able to control any of the other party's video cameras. You will only be able to control your own video camera.
- In order for other parties to be able to control your video camera, you must set "**CAM ctrl from remote site(s)**" in your settings to "**ON**" (by default, it is set to "**OFF**") (Page 131).
- The Main Site can operate the cameras of all sites, and Sub Sites can operate their own camera and the camera of the site being displayed as the main display at the Main Site.
- For video conference calls with multiple connections that use an internal MCU, in order for a sub site to control a camera of another site, the main site's "**Camera control transmitting**" setting (default: "**OFF**") must be set to "**ON**" (Page 126), and the "**CAM ctrl from remote site(s)**" setting (default "**OFF**") must be set to "**ON**" (Page 131).

Operating your own video camera directly

You can directly perform PTZ (pan/tilt/zoom) operations from the home screen and the video conference call screen using the remote control.

1. [▲][▼]: Tilt the video camera up/down.
2. [◀][▶]: Pan the video camera left/right.
3. [ZOOM (+/-)]: Zoom in/zoom out the video camera.

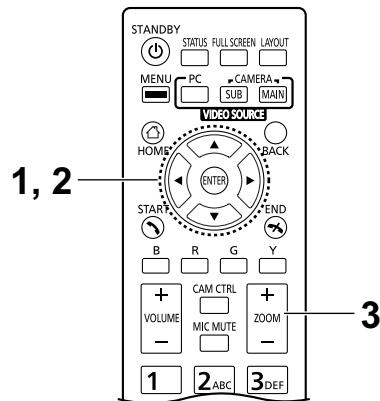

Note

- Your own video camera's image will be displayed when operations are performed during a call so that you can confirm the operations. If no operation is made for approximately 3 seconds, the original screen is displayed.

Operation from the video camera menu

- Press **[CAM CTRL]**.
 - The site selection dialogue box is displayed.

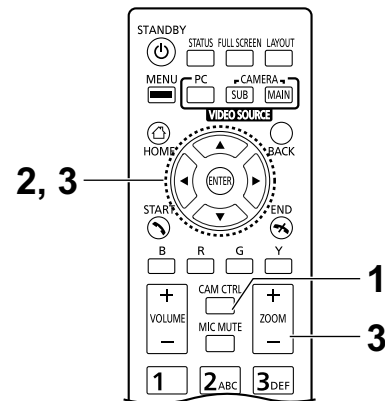

Note

- After the site selection dialogue box is displayed, if no operations are performed within approximately 10 seconds, the dialogue box will disappear.

- Use **[▲]****[▼]** to select the site to display and press **[ENTER]**.
 - The camera control screen is displayed.



- 3 Press the buttons on the remote control to operate the video camera.
 - [ZOOM (+/-)]**: Zoom in/zoom out
 - [◀][▶]**: Pan the video camera left/right.
 - [▲][▼]**: Tilt the video camera up/down.
- The movement continues as long as you hold down the button, and stops when you release the button. For finer control of the movement, press the button and immediately release it, and repeat this in succession.
- To return to the video conference call screen, press **[BACK]**.

Note

- You can press **[FULL SCREEN]** on the remote control to display/hide the guide area. You can specify in the administrator menu (Page 153) whether the entire guide area is hidden, or only a portion of it.
- In the following cases, you will not be able to control a video camera, even if you press **[CAM CTRL]**.
 - While displaying the unit information screen or the connections status screen.
 - While displaying a dialogue box.

Registering a Preset

When you are not on a video conference call, you can register up to 9 presets (pan, tilt, zoom position, etc.) of the video camera connected as the main or sub video camera on your side.

Note

- Preset registration can only be performed when using video cameras that support preset functions. For details, contact your dealer.
- The features that can be used may be limited depending on your video camera model. (e.g., A video camera with only a zoom feature)

1 Press [Home].

- The Home screen is displayed.

Note

- If you are registering presets for the sub video camera, press [CAMERA SUB].

2 Press [CAM CTRL].

- The camera control screen for your own video camera is displayed.

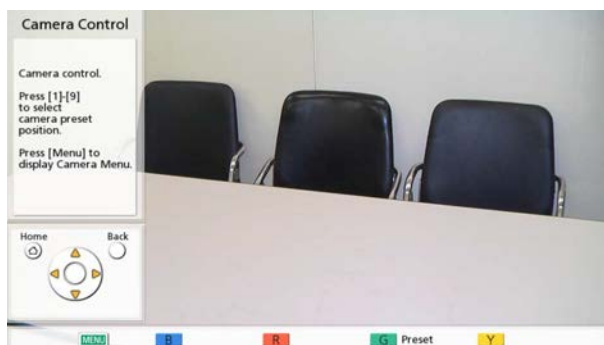

3 Press [G].

- The preset screen is displayed.

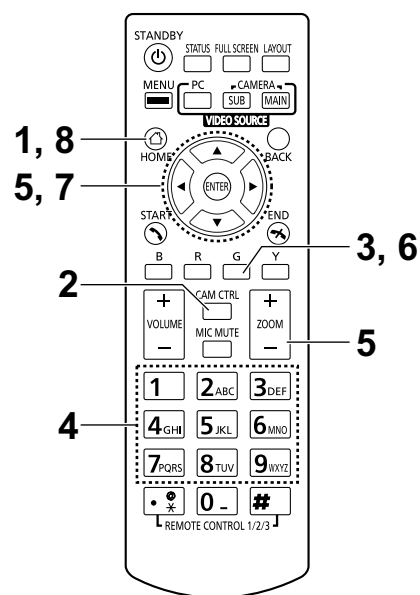

- 4 Press a numeric button (1–9) to select the preset number to use.
 - The selected preset number is displayed in the upper right corner of the screen.

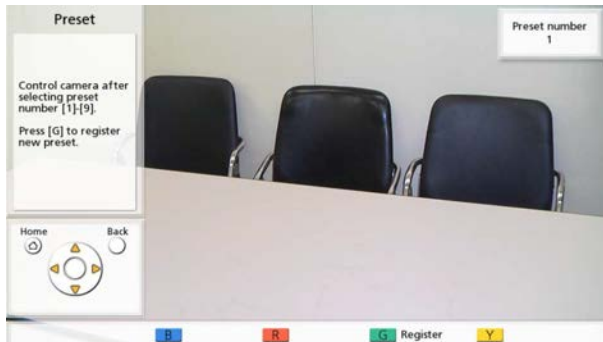

Note

- When a preset number that has already been registered is selected and preset registration is performed, that preset's registered information will be overwritten.
- 5 Press the buttons on the remote control to adjust the video camera's preset.
[ZOOM (+/-)]: Zoom in/zoom out
[◀][▶]: Pan the video camera left/right.
[▲][▼]: Tilt the video camera up/down.
 - 6 Press **[G]**.
 - A dialogue box to confirm the saving of settings is displayed.
 - 7 Use **[◀][▶]** to select "Yes" and press **[ENTER]**.
 - The preset screen is displayed.

Note

- To continue making settings, repeat steps 4–7.
- 8 Press **[Home]**.
 - The Home screen is displayed.

Note

- Preset registration information for a video camera is saved in that video camera. If a video camera is initialised, its preset registration information will be lost. In such cases, preset registration must be performed on the unit again.

Recalling a Registered Preset

During a video conference call, you can set your own video camera's direction, zoom and magnifier settings, etc., to the desired state by selecting a registered preset.

Note

- For details about compatible video camera models, contact your dealer.
- You can recall a preset that was set by the other party for the other party's video camera during a video conference call.

1 Press [CAM CTRL].

- The site selection dialogue box is displayed.



Note

- After the site selection dialogue box is displayed, if no operations are performed within approximately 10 seconds, the dialogue box will disappear.

2 Use [▲][▼] to select "Local Site" and press [ENTER].

- The camera control screen is displayed.



3 Press a numeric button (1–9) to select the preset number that you want to recall.

- The direction and zoom of your video camera will change to that of the registered preset.

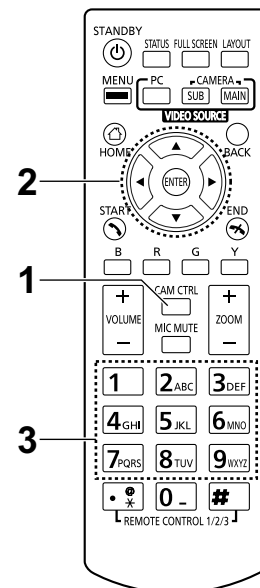

Changing Video Camera Settings

Whether or not you are on a video conference call, you can set the brightness and white balance, etc., of the video camera connected as the main or sub video camera on your side.

Note

- You may not be able to change the settings depending on your video camera model. For details about compatible video camera models, contact your dealer.

1 Press [CAM CTRL].

- The site selection dialogue box is displayed.

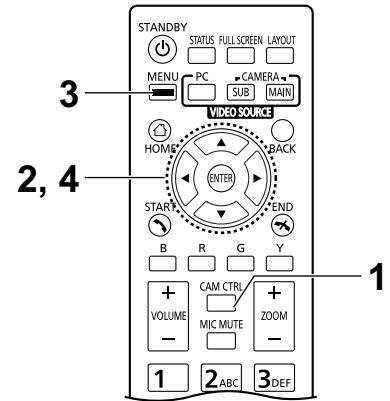
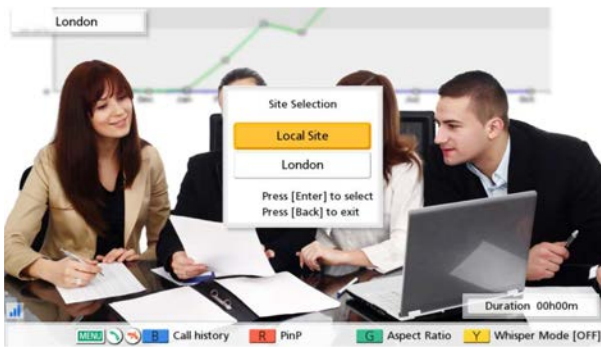

Note

- After the site selection dialogue box is displayed, if no operations are performed within approximately 10 seconds, the dialogue box will disappear.

2 Use [▲][▼] to select "Local Site" and press [ENTER].

- The camera control screen is displayed.



- 3 Press **[MENU]**.
- The camera menu screen is displayed.



- 4 Use **[▲]**/**[▼]** to select the item you want to set, and press **[ENTER]**.
- The setting screen for the selected item is displayed.

Note

- The items are displayed across 2 screens. You can display all items by pressing **[R]** (or **[▶]**) to move to the next screen and pressing **[B]** (or **[◀]**) to move to the previous screen.
- Some items may not be displayed depending on your video camera model.
- While you are configuring settings on the camera menu screen, other parties cannot control your video camera.

"Brightness" screen

"Brightness Mode": Press **[ENTER]** and use **[▲]**/**[▼]** to select **"Auto"** or **"Manual"**.

Note

- When **"Manual"** is selected, you can adjust the brightness by pressing the buttons on the remote control.
[B]: Dark
[R]: Light

"White Balance" screen

This function adjusts the colour so that white colours always appear white under various types of light sources.

"White Balance": Press [ENTER] and use [▲][▼] to select the desired value for the white balance ("**Auto**", "**Indoor 1**", "**Indoor 2**", "**Outdoor (Sunny)**", "**Outdoor (Cloudy)**", or "**Calibrate**").

Note

- Unless the colour is unnatural due to the light source, for instance, select "**Auto**".
- "**Indoor 1**" is recommended if the light source is an incandescent lamp, etc. "**Indoor 2**" is recommended if the light source is a warm, white fluorescent lamp, sodium vapour lamp, etc.
- When "**Calibrate**" is selected, you can adjust the white balance. Perform the following procedure:
 1. Press [ENTER].
 - If the white balance had been set before by selecting "**Calibrate**", that previously set state will be recalled.
 2. Turn a piece of white paper toward the video camera.
 3. Press [G].

"Focus" screen: Use [▲][▼] to select the following items for input:

"Focus Position": Press [ENTER] and use [▲][▼] to select "**Center**" or "**Sides (Wide)**".

"Focus Mode": Press [ENTER] and use [▲][▼] to select "**Auto**" or "**Manual**".

Note

- When "**Manual**" is selected, you can adjust the focus by pressing the buttons on the remote control.
[B]: Near
[R]: Far

"Backlight" screen

This function adjusts the colour so that backlit objects do not appear dark.

"Backlight Compensation": Press [ENTER] and use [▲][▼] to select "**ON**" or "**OFF**".

"Flicker" screen

This function corrects screen flicker.

"Flicker Compensation": Press [ENTER] and use [▲][▼] to select "**ON**" or "**OFF**".

"Digital Zoom" screen

This function crops the centre part of the video image and enlarges it through digital processing.

"Digital Zoom": Press [ENTER] and use [▲][▼] to select "ON" or "OFF".

"Magnifier Settings" screen

This function crops a part of the video image and displays it in the four corners of the screen.

"Magnifier": Press [ENTER] and use [▲][▼] to select "ON" or "OFF".

Note

- If you want to use the magnifier function, perform the following procedure:

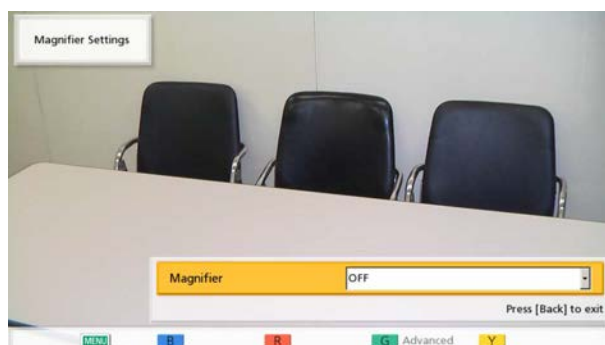

1. Select "ON" and press [ENTER].
 - Your own image is displayed in full screen, and a magnified image of your own is displayed in the upper right subscreen.

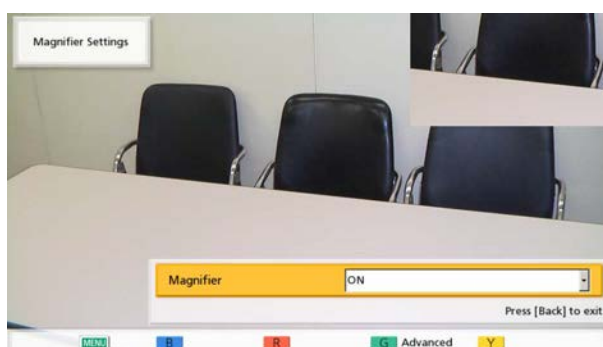

- 2. Configure the advanced settings of the magnifier by pressing the **[G]** button on the remote control.

Note

- The magnifier settings can be registered as a preset (Page 95).

(To change which position to magnify):

If you want to change which content to magnify, adjust the magnification position by pressing **[▲][▼][◀][▶]** to move the frame that indicates the area to magnify.

(To change the zoom level of the magnified image):

If you want to change the size of the magnified image displayed in the subscreen, press **[ZOOM (+)]** to zoom in, and press **[ZOOM (-)]** to zoom out.

(To change the screen layout):

If you want to change the position of the magnified image on the screen, press **[Y]**. Each time you press **[Y]**, the position of the magnified image will change in the following order:

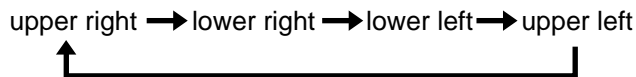

Example: When the dotted-line part is magnified and displayed in the upper left subscreen.



- 3. To return to the magnifier settings screen, press **[BACK]**.
To return to the camera menu screen, press **[MENU]**.

"Sharpness" screen

This function adjusts the sharpness of the contours of images.

"Sharpness": Press **[ENTER]** and use **[▲][▼]** to select **"High"**, **"Medium"**, **"Low"**, or **"Off"**.

"Noise Filter" screen

This function filters the image noise when there is low illumination, etc. If a high setting is used, residual images may be increased.

"Noise Filter": Press **[ENTER]** and use **[▲][▼]** to select **"High"**, **"Medium"**, **"Low"**, or **"Off"**.

Note

- After completing settings on each settings screen, press **[ENTER]**. After that, pressing **[MENU]** or **[BACK]** will display the camera menu screen.

Displaying the Connection Status

You can confirm the connection status of the network and peripheral devices.

- 1 Press **[STATUS]**.
 - The connections status screen is displayed. A "--" mark is displayed next to any network or peripheral devices connection that is not in normal operation or not connected.

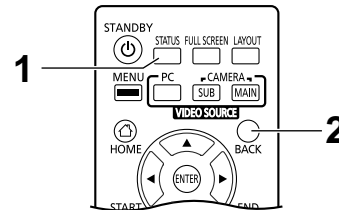
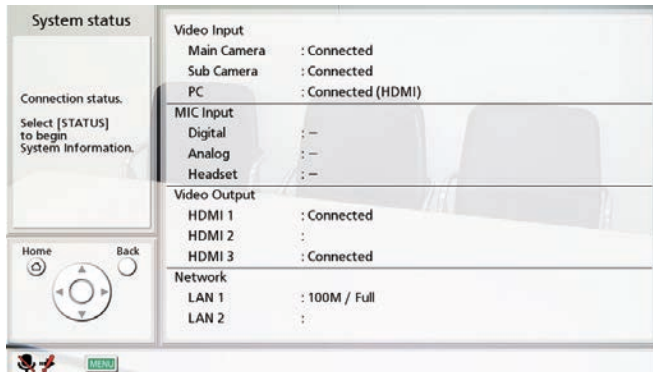

- 2 Press **[BACK]**.
 - The display returns to the screen in use before the connections status screen was viewed.

Note

- During a call, press **[STATUS]** twice at step 1.
- **"Digital"** is not displayed for **"MIC Input"** for the KX-VC1000.
- If the KX-VC1000 has not been expanded for HDMI Dual Monitor support, **"HDMI 2"** is not displayed for **"Video Output"**.
- **"HDMI 3"** for **"Video Output"** and **"LAN 2"** for **"Network"** are only displayed for the KX-VC1600/KX-VC2000.

Displaying Unit Information

Note

- Describes the information displayed for devices other than those that are currently being used in a multicast. For the display of information for devices that are currently being used in a multicast, refer to "Confirming the Transmission Status During a Multicast (Multicast Terminal) (Page 181)" and "Confirming the Transmission Status During a Multicast (Relay Terminal/Receiver Terminal) (Page 182)".

1 Press **[STATUS]** twice.

- The unit information screen is displayed.

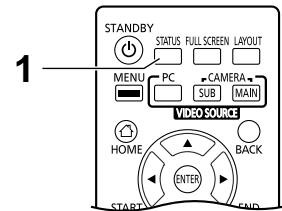
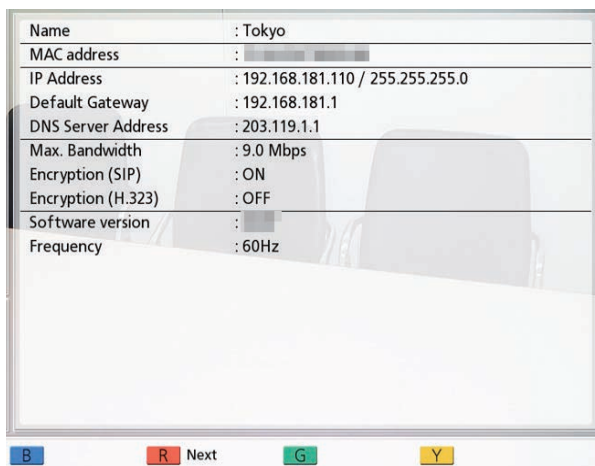

- The unit information display screen is displayed over 2 to 3 screens. To view all the items, press **[R]** to move to the next page, and press **[B]** to move to the previous page.

Note

- The status of communication encryption (**ON/OFF/Best effort**) is displayed under "**Encryption (SIP)**"/"**Encryption (H.323)**"/"**Encryption (NAT Traversal)**".
- When not in a video conference call, the first and second pages display information for your own site.
- When in a video conference call, the first page displays information for the other party's site and second and third pages display information for your own site. The first page of information can be used to confirm the network's status during a call, including the connection bandwidth and the packet loss ratio.
- During a multiple-party video conference call, pressing **[G]** on the first page will display the site selection dialogue box, where the displayed site can be changed. **[◀]** **[▶]** can also be used instead of **[G]** to change the displayed site. When using a KX-VC1000 that has not been expanded for 4 Point Built-in MCU support, **[G]**, **[◀]** and **[▶]** are unavailable.
- The site that has a black line displayed on the left in the site selection dialogue box is the site with the lowest bandwidth (if there are two types of communication groups due to "**Secondary Bandwidth Selection**" (Page 126), a black line is displayed in the site with the lowest bandwidth for each group).

Adding Contacts to the Contact List

You can register the information of up to 600 contacts in the contact list.

Note

- If a video conference call is received while data is being entered, a dialogue box to confirm if you answer a video conference call is displayed. Use [◀][▶] to select "Yes" or "No" and press [ENTER].
 - When "Yes" is selected, you can answer a video conference call while any unsaved data is lost.
 - When "No" is selected, you can continue entering the data.
- You can use the administrator menu to prohibit adding, editing, and deleting items in the contacts list (Page 153).

Registering a New Contact

- Press [MENU].
 - The Menu screen is displayed.
- Use [▲][▼] to select "Contact List" and press [ENTER].
- Press [B].
 - The contact list registration screen is displayed.

Site	
Speed Dial	4
Max. Bandwidth	Not Specified
Connection mode	IP Mode (SIP)
Address	

B abc R a l G Save Y Clear

- Use [▲][▼] to select the following items for input:
 - "Site": Enter a name for the contact (up to 24 characters) (Page 190).
 - "Speed Dial": Enter a speed dial number (1–600).
 - "Max. Bandwidth": Press [ENTER] and use [▲][▼] to select the maximum allowed bandwidth to be used ("256 kbps"–"18 Mbps", or "Not Specified" [default]).

Note

- When "Not Specified" is selected, the maximum bandwidth that is set on the connection settings screen (Page 122) is applied.
- The maximum bandwidth during a video conference call adjusts to that of the party that has set the lowest bandwidth for the maximum bandwidth setting among all participating parties.
- Video conferences cannot use more bandwidth than the maximum bandwidth setting set by your dealer. For details, contact your dealer.

"Connection mode": Press [ENTER] and use [▲][▼] to select the connection mode (call type) ("IP Mode (SIP)", "IP Mode (H.323)", or "NAT Traversal Mode").

"Address": Enter an IP address (or host name), SIP URI (or SIP user name), H.323 extension, H.323 name, MCU's conference room number@IP address, or connection number.

Note

- When entering an IPv4 address, if the IP address contains 1 or 2 digit numbers, enter these numbers as they are. Do not enter like [001].
 - Example: The IP address is [192.168.0.1].
 - Correct entry: [192.168.0.1]
 - Wrong entry: [192.168.000.001]
- For the IPv6 address input format, refer to Page 47.
- When entering an IPv6 address with a port number appended, enclose the IPv6 address in square brackets. (Input example) [2001:db8::10]:5060
- See Page 47 for details about the characters that can be input for address entry.
- If the other party has the same SIP domain name as yours, you can register only their SIP user name. If the other party has a different SIP domain name from yours, their

SIP domain name must be entered along with their SIP user name.

- If the SIP domain name is not entered, your own SIP domain name is automatically appended to the registered contact. This may result in a different, unintended party being registered as a contact, so be careful when entering a contact's information.
- When using H.323, you can also call by entering the other party's IP address (or host name) %H.323 extension (or H.323 name).
- Enter a standards-compliant value. For details, contact your network administrator.

5. Press **[G]**.

- A dialogue box to confirm the saving of settings is displayed.

6. Use **[◀][▶]** to select "Yes" and press **[ENTER]**.

- The contact list screen is displayed.

Note

- To continue entering another contact, press **[B]** and repeat steps 4–6.

7. Press **[Home]**.

- The Home screen is displayed.

Editing Contact Information

1. Press **[MENU]**.

- The Menu screen is displayed.

2. Use **[▲][▼]** to select "Contact List" and press **[ENTER]**.

- The contact list screen is displayed.

3. Use **[▲][▼]** to select the contact you want to edit.

- You can use **[◀][▶]** or the numeric buttons of the remote control to select the displayed tab (Page 53).

4. Press **[ENTER]**.

- The contact list details screen is displayed.

5. Press **[G]**.

- The contact list edit screen is displayed.

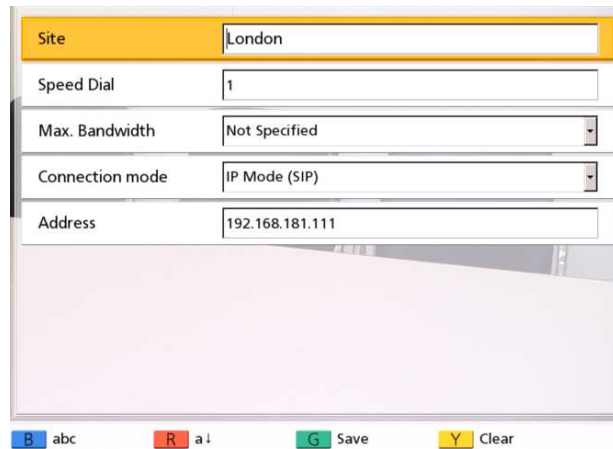

6. Use **[▲][▼]** to select the item you want to edit and make any changes.

7. Press **[G]**.

- A dialogue box to confirm the saving of settings is displayed.

8. Use **[◀][▶]** to select "Yes" and press **[ENTER]**.

- The contact list details screen is displayed.

9. Press **[Home]**.

- The Home screen is displayed.

Deleting a Contact

1. Press **[MENU]**.

- The Menu screen is displayed.

2. Use [▲][▼] to select "Contact List" and press [ENTER].
 - The contact list screen is displayed.

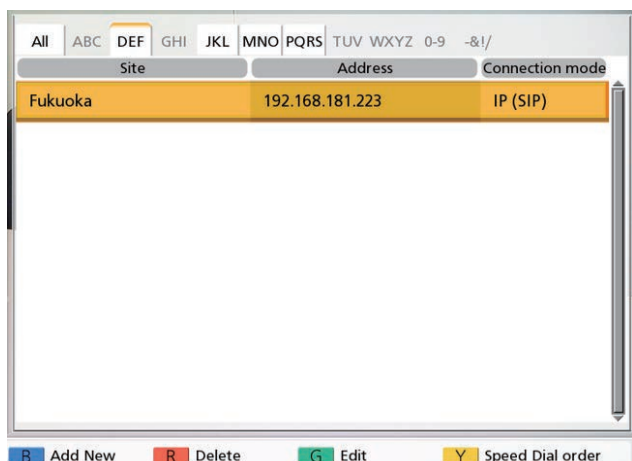

3. Use [▲][▼] to select the contact you want to delete.
 - You can use [◀][▶] or the numeric buttons of the remote control to select the displayed tab (Page 53).
4. Press [R].
 - A dialogue box to confirm the deletion is displayed.
5. Use [◀][▶] to select "Yes" and press [ENTER].
 - The contact list screen is displayed.
6. Press [Home].
 - The Home screen is displayed.

Registering a Contact from the Call History

You can register a contact to the contact list from the call history.

1. Press [MENU].
 - The Menu screen is displayed.
2. Use [▲][▼] to select "Call History" and press [ENTER].
 - The outgoing call history screen is displayed.

Note

- To refer to the incoming call history, press [G].

3. Use [▲][▼] to select the single-party entry you want to add as a contact, and press [B].
 - The contact list registration screen is displayed.

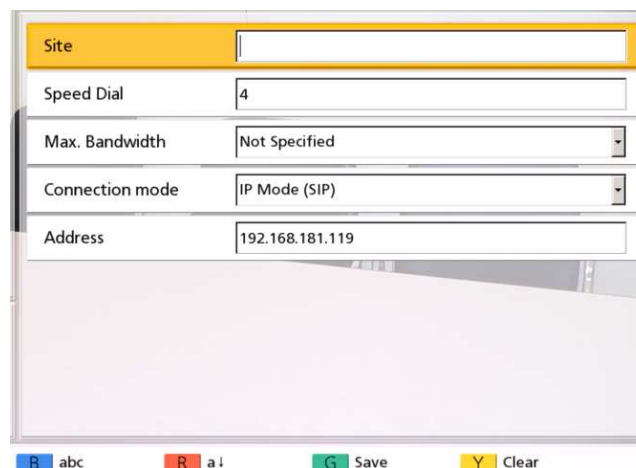

4. Use [▲][▼] to select the necessary items and input information.
5. Press [G].
 - A dialogue box to confirm the saving of settings is displayed.
6. Use [◀][▶] to select "Yes" and press [ENTER].
 - The outgoing or incoming call history screen is displayed, depending on which of the screens you displayed in step 2.
7. Press [Home].
 - The Home screen is displayed.

Registering a Profile

You can register the settings required for starting for a video conference call in advance as a profile, including the sites that can join the call, the communication type, and the screen layout. Up to 20 profiles can be set.

Note

- To use profiles with the KX-VC1000, you must use an activation key to enable 4 Point Built-in MCU support (Page 20).

Registering a New Profile

- Press [MENU].
 - The Menu screen is displayed.
- Use [▲][▼] to select "Profile" and press [ENTER].
 - The profile list screen is displayed.
- Use [▲][▼] to select ""Not Registered"".
- Press [B].
 - The profile settings screen is displayed.



- Use [▲][▼] to select the following items for input

Note

- The items are displayed over 2 screens. If you are not entering text, you can move to the next or previous screen by pressing [R] or [B], respectively.
- While performing step 5, you can configure "Site" (explained in steps 6 to 8) and "Audio Mixing Site" (explained in steps 9 to 11), however, you must configure "Site" before you configure "Audio Mixing Site".

"Group": Enter a name for the profile (up to 24 characters) (Page 190).

"Entry Restriction": Use [◀][▶] to select whether to restrict sites that have not been registered from joining a conference room.

- "ON"**: Entry to conference rooms is restricted.
- "OFF"** (default): Entry to conference rooms is not restricted.

"Site name display": Use [◀][▶] to select whether to display site names during a multiple-party connection.

- "ON"** (default): Display site names.
- "OFF"**: Do not display site names.

Note

- For images displayed using HDMI 1 at the main site, you can display the name of each site on the layout screen. Note, however, that when using PwithP or SideBySide for camera or content layout, the site name is not displayed even when using HDMI 1 (Page 150).
- When using presentation mode, site names are displayed in the composite image of sub sites.

"Other Site's Audio": Press [ENTER] and use [▲][▼] to select the site whose audio you want to mute during a multiple-party connection.

- "Mix (Auto)"** (default): Audio from the loudest 4 sites is automatically mixed together.
- "Mix (Selection)"**: The audio from the selected sites (up to 4) is mixed together.
- "Mute"**: Mutes the other site's audio.

Note

- When **"Mix (Selection)"** is selected, set **"Audio Mixing Site"** (set **"Site"** settings before setting **"Audio Mixing Site"**).

"MCU Mode": Press [ENTER] and use [▲][▼] to select the MCU mode used when starting a video conference.

- "Discussion"** (default): The same image is displayed for the main site and sub sites. This mode is suited to discussion-style conferences.
- "Presentation"**: The main site sees a composite image including the sub sites, and the sub sites see the image from the main site only. This mode is suited to lecture-style conferences.

"Screen Layout (Discussion)": Press [ENTER] and use [▲][▼] to select the screen layout for Discussion Mode.

- **"Auto"** (default): Automatically changes the layout depending on the number of sites joining a video conference call.
- **"CP1"** to **"CP28"**: The selected screen layout is used (Page 73).

"Screen Layout (Presentation)": Press [ENTER] and use [▲][▼] to select the screen layout for Presentation Mode.

- **"Auto"** (default): Automatically changes the layout depending on the number of sites joining a video conference call.
- **"CP1"** to **"CP28"**: The selected screen layout is used (Page 73).

"Main Position (Discussion)": Press [ENTER] and use [▲][▼] to select the screen to display as the main display (display priority 1).

- **"Local Site"** (default): Displays your own site.
- **"Voice Activation 1"**: The site with the loudest volume is automatically displayed as the main display.
- **"Voice Activation 2 (Local Site)":** Your own site's image is displayed as the main display, and the site with the loudest volume at the time is displayed as display priority 2.
- **"Voice Activation 2 (Site 1)"** to **"Voice Activation 2 (Site 30)":** The selected site is displayed as the main display, and the site with the loudest volume at the time is displayed as display priority 2.
- **"Site 1"** to **"Site 30"**: The selected site is displayed as the main display.
- **"Specified Position"**: Displays each site's image in the specified position.

Note

- When **"Specified Position"** is selected, the main site is displayed at the position specified by **"Display position of local site"**. Sub sites are displayed in the display position (except for the main site's display position) determined by their priority, which is determined by the **"Site"** ID assigned to their profile settings (lower IDs have priority).
For information about the relationship between display priority order and display positions, see (Page 73).

"Main Position (Presentation)": Press [ENTER] and use [▲][▼] to select the screen to display as the main display (display priority 1).

- **"Site 1"** (default) to **"Site 30"**: The selected site is displayed as the main display.

- **"Specified Position"**: Displays each sub site's image in the specified position.

Note

- When **"Specified Position"** is selected, sites are displayed in the display position determined by their priority, which is determined by the **"Site"** ID assigned to their profile settings (lower IDs have priority).
For information about the relationship between display priority order and display positions, see (Page 73).

"Display position of local site": Press [ENTER] and use [▲][▼] to select the display position of your site (display priority position; 1 (default) to 24).

Note

- This setting is only available when **"Specified Position"** is selected for **"Main Position (Discussion)"**.
- If the specified display position is greater than the number of connected sub sites, the display position automatically moves forward.
- For information about the relationship between display priority order and display positions, see (Page 73).

"Display position setting": Press [ENTER] and use [▲][▼] to select what happens when the site assigned to the display position is not connected.

- **"Move forward"** (default): Available sites move forward in their display position.
- **"Black screen"**: A black screen is displayed for any sites that are not connected.

Note

- This setting is only available when **"Specified Position"** is selected for **"Main Position (Discussion)"** or **"Main Position (Presentation)"**.

6. Use [▲][▼] to select "Site" and press [ENTER].
 - The site selection screen is displayed.



Note

- If there are no registered contacts with a "✓" mark in the selection column, a call will not be made even if [START] is pressed.
- Press [Y] to return to the profile settings screen (first page).
- Up to 30 connections can be registered, but the number of usable connections will be automatically selected from the top after invalid settings ("Not Registered" and "Connection mode (Call type)") are excluded.

7. Use [▲][▼] to select ""Not Registered"" and press [B].
 - A dialogue box is displayed for selecting the input method.



When "Input Address" is selected

- The address input screen is displayed.
- ① Use [▲][▼] to select the following items for input:
 - "Connection mode": Press [ENTER] and use [▲][▼] to select the connection mode (communication type) and press [ENTER].
 - "IP Mode (SIP)" (default): SIP is used for communication.

- "IP Mode (H.323)": H.323 is used for communication.
 - "NAT Traversal Mode": NAT Traversal Mode is used for communication.
- ② "Address": Enter an IP address (or host name), SIP URI (or SIP user name), H.323 extension, H.323 name, MCU's conference room number@IP address, or connection number.
 - ③ Press [G].
 - The site selection screen is displayed.

When selecting "Contact list":

- The contact list screen is displayed.
- ① Use [▲][▼] to select the other party to register, and press [ENTER].
 - The site selection screen is displayed.

When selecting "Call History":

- The outgoing call history selection screen is displayed.
- ① Use [▲][▼] to select the other party to register, and press [ENTER].
 - The site selection screen is displayed.

Note

- After performing step 7, if you do not set "Audio Mixing Site" or any of the items in step 5, do not perform steps 8-11 and proceed from step 12.

8. Press [Y].
The profile settings screen (first page) is displayed.
9. Use [▲][▼] to select "Audio Mixing Site" and press [ENTER].
 - The audio mixing site screen is displayed.

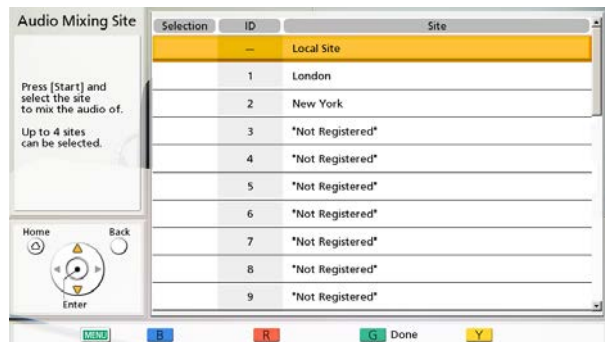

Note

- This setting is only necessary when "Other Site's Audio" is set to "Mix (Selection)".

10. Use [▲][▼] to select the sites whose audio you want to mix and press [ENTER].

- Press [ENTER] to select/deselect the desired sites. You can select up to 4 sites.

Note

- If no sites are registered, only your own site can be selected. Perform steps 6-8 first and setup a site.

11. Press [G].

- The profile settings screen is displayed.

12. Press [G].

- A dialogue box to confirm the saving of settings is displayed.

13. Use [◀][▶] to select "Yes" and press [ENTER].

- The profile list screen is displayed.

14. Press [Home].

- The Home screen is displayed.

Note

- To continue entering another profile, press [B] from the profile list and repeat steps 3-13.

Editing Profile Information

1. Press [MENU].

- The Menu screen is displayed.

2. Use [▲][▼] to select "Profile" and press [ENTER].

- The profile list screen is displayed.

3. Use [▲][▼] to select the profile you want to edit.

4. Press [B].

- The profile settings screen is displayed.

Note

- The items are displayed over 2 screens. If you are not entering text, you can move to the next or previous screen by pressing [R] or [B], respectively.

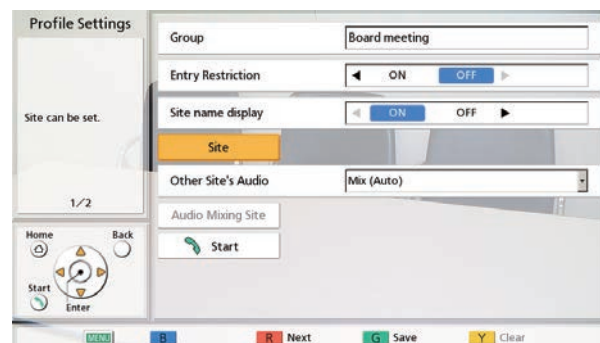

5. Use [▲][▼] to select the item you want to edit and make any changes.

6. Press [G].

- A dialogue box to confirm the saving of settings is displayed.

7. Use [◀][▶] to select "Yes" and press [ENTER].

- The profile list screen is displayed.

8. Press [Home].

- The Home screen is displayed.

Deleting a Profile

1. Press [MENU].

- The Menu screen is displayed.

2. Use [▲][▼] to select "Profile" and press [ENTER].

- The profile list screen is displayed.

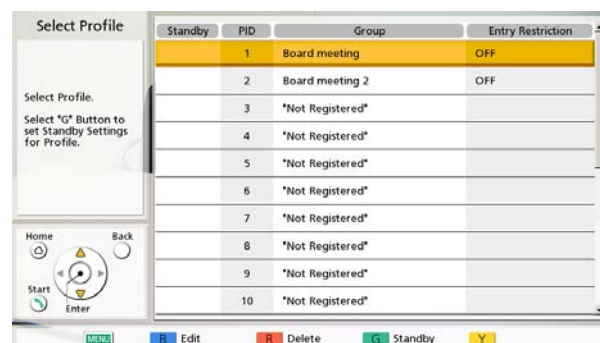

3. Use [▲][▼] to select the profile you want to delete.

4. Press [R].

- A dialogue box to confirm the deletion is displayed.

5. Use [◀][▶] to select "Yes" and press [ENTER].
 - The profile list screen is displayed.
6. Press [Home].
 - The Home screen is displayed.

Setting the Profile Standby

When an incoming call is received during standby, the specified conference registered to the profile is started.

Note

- Even in the profile standby settings, there are no restrictions to the call operations (such as how to make calls and addresses) during standby.
 - During profile standby settings, if another profile standby is configured, the first profile standby that was configured is removed.
 - For profiles that have "Entry Restriction" set to "ON", calls are answered and conferences are started with profile settings only if there is a call from the sites registered in "Site".
 - The profile standby setting is set as standby for the selected local site (page 113) from the moment it is set, and is only enabled while that local site is selected. If the local site is changed, the profile standby is also changed to the content of the changed local site while that local site is selected.
1. Press [MENU].
 - The Menu screen is displayed.
 2. Use [▲][▼] to select "Profile" and press [ENTER].
 - The profile list screen is displayed.
 3. Use [▲][▼] to select the profile standby you want to use.

Note

 - The ""Not Registered"" line cannot be selected.
 4. Press [G].
 - A dialogue box for setting or removing profile standby is displayed.

5. Use [◀][▶] to select "Temporary" or "Permanent".
 - The profile list screen is displayed and a "✓" is displayed in the "Standby" column for the profile with a standby set.

Note

- If "Temporary" is selected, the profile standby setting is removed if the unit is restarted. If "Permanent" is selected, the profile standby setting is kept even after restarting the unit.
 - If [BACK] is pressed, profile standby is not set and the display is returned to the profile list screen.
6. Press [Home].
 - The Home screen is displayed.

Removing a Profile Standby

1. Press [MENU].
 - The Menu screen is displayed.
2. Use [▲][▼] to select "Profile" and press [ENTER].
 - The profile list screen is displayed and a "✓" is displayed in the "Standby" column for the profile with a standby set.
3. Use [▲][▼] to select the profile standby you want to remove.
4. Press [G].
 - A dialogue box for setting or removing profile standby is displayed.
5. Use [◀][▶] to select "Release".
 - The profile list screen is displayed and a "✓" is deleted from the "Standby" column for the profile with a standby removed.

Note

- If [BACK] is pressed, profile standby is not removed and the display is returned to the profile list screen.
6. Press [Home].
 - The Home screen is displayed.

Making Local Site Settings

You can register up to 10 local sites. The same unit can be used in multiple meeting rooms without the need to change the network or connection mode settings.

Note

- You can use the administrator menu to hide the select local site screen (Page 153).

Registering a Local Site

- Press [MENU].
 - The Menu screen is displayed.
- Use [▲][▼] to select "Select local site" and press [ENTER].
 - The select local site screen is displayed.
- Use [▲][▼] to select ""Not Registered"" and press [B].
 - The local site settings screen is displayed.

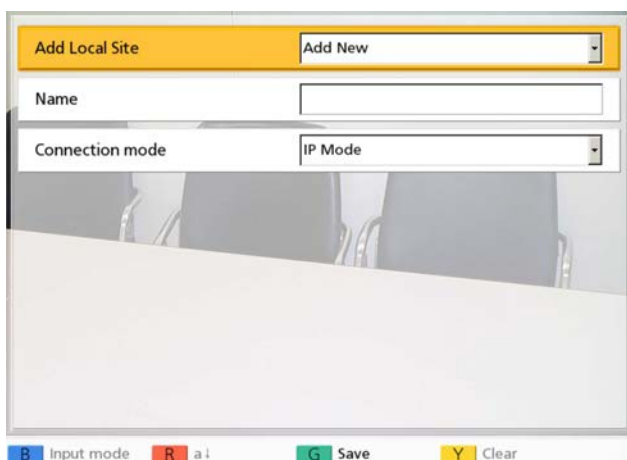

- Use [▲][▼] to select the following items for input:
 - "Add Local Site": Press [ENTER], and use [▲][▼] to select a creation method.
 - "Add New" (default): Create new entries.
 - "Copy from basic settings": Re-use the settings of the top row of the local site selection screen (basic settings).
 - "Copy from (1) 'Name'" to "Copy from (9) 'Name'": The numbers 1 through 9 correspond to local site IDs. "Name" will be the device names already set to local site IDs 1 through 9.

"Name": Enter a device name for the local site.
 "Connection mode": Press [ENTER] and use [▲][▼] to select a connection mode (IP Mode, NAT Traversal Mode, IP / NAT Traversal Mode) (default: "IP Mode").

- Press [G].
 - A dialogue box to confirm the saving of settings is displayed.
- Use [◀][▶] to select "Yes" and press [ENTER].
 - The select local site screen is displayed.

Selecting a Local Site

- Press [MENU].
 - The Menu screen is displayed.
- Use [▲][▼] to select "Select local site" and press [ENTER].
 - The select local site screen is displayed.

Selected	ID	Name	Connection mode
→	—	Tokyo	IP
	1	room1	IP
	2	room2	IP
	3	room3	IP / NAT Traversal
	4	room4	NAT Traversal
	5	*Not Registered*	
	6	*Not Registered*	
	7	*Not Registered*	
	8	*Not Registered*	
	9	*Not Registered*	

[B] Add New [R] Delete [G] Set [Y] Release

- Use [▲][▼] to select the local site you want to use.

Note

- For the currently selected local site, "→" is displayed in "Selected".
- "*Not Registered*" is displayed for sites that have not been registered.

- Press [G].
 - A dialogue box to confirm the use of the selected local site is displayed.

5. Use [◀][▶] to select "Yes" and press [ENTER].
 - The unit restarts automatically.

Note

- When changing the connection mode, the time required for a restart may depend on network conditions.
- Restarting the unit once more will return the local site to the basic settings (the first line of the local site selection settings). To keep the selection after restarting, set "Same setting after restart" to "ON" (Page 156).
- System settings and administrator menu settings can be performed for each local site. When settings are changed and saved while the local site is in the switched status, those settings will be valid only when that local site is selected.

6. Press [Home].
 - The Home screen is displayed.

Deleting Local Site Information

1. Press [MENU].
 - The Menu screen is displayed.
2. Use [▲][▼] to select "Select local site" and press [ENTER].
 - The select local site screen is displayed.

Selected	ID	Name	Connection mode
➔	—	Tokyo	IP
	1	room1	IP
	2	room2	IP
	3	room3	IP / NAT Traversal
	4	room4	NAT Traversal
	5	*Not Registered*	
	6	*Not Registered*	
	7	*Not Registered*	
	8	*Not Registered*	
	9	*Not Registered*	

B Add New R Delete G Set Y Release

3. Use [▲][▼] to select the local site you want to delete.
4. Press [R].
 - A dialogue box to confirm deletion is displayed.
5. Use [◀][▶] to select "Yes" and press [ENTER].
 - The select local site screen is displayed.

Changing System Settings/Performing System Maintenance

You can set, change, and confirm the unit's various function settings.

Note

- If a video conference call is received while data is being entered, a dialogue box to confirm if you answer a video conference call is displayed.
Use [**◀**][**▶**] to select "Yes" or "No" and press [**ENTER**].
 - When "Yes" is selected, you can answer a video conference call while any unsaved data is lost.
 - When "No" is selected, you can continue entering the data.

1. Press [**MENU**].
 - The Menu screen is displayed.
2. Use [**▲**][**▼**] to select "Settings" and press [**ENTER**].
 - The system settings screen is displayed.

System Setting Screen List

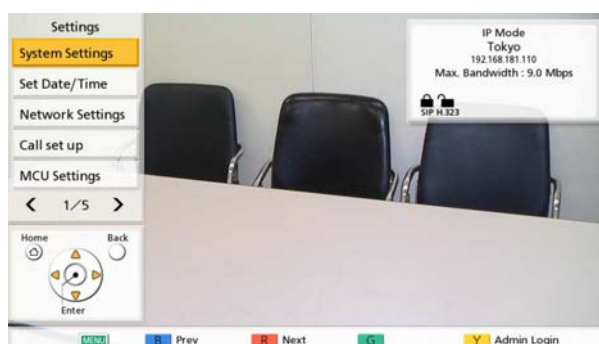

- 1 System Settings:
Sets the device's name (Page 118).
- 2 Set Date/Time:
Sets the date and time (Page 118).
- 3 Network Settings:
Sets the network settings (Page 118).
- 4 Call set up:
Sets items used during communication (Page 121).
- 5 MCU Settings:
Sets the settings for the built-in MCU (Page 124).

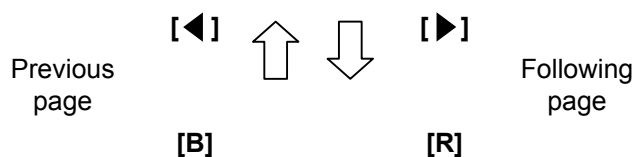

Contacts and Settings

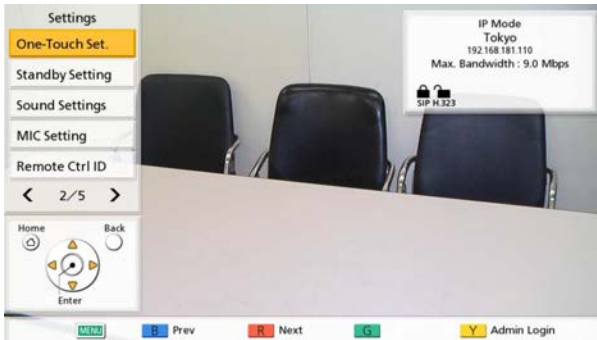

- ⑥ **One-Touch Set.:**
Sets the one-touch connection numbers displayed on the Home screen (Page 127).
- ⑦ **Standby Setting:**
Sets the time until screen standby mode is activated (Page 127).
- ⑧ **Sound Settings:**
Sets the sounds played at startup and when a video conference call starts (Page 127).
- ⑨ **MIC Setting:**
Sets the positioning for proprietary digital boundary microphones (Page 128).
- ⑩ **Remote Ctrl ID:**
Sets IDs for the remote control and the main unit (Page 130).

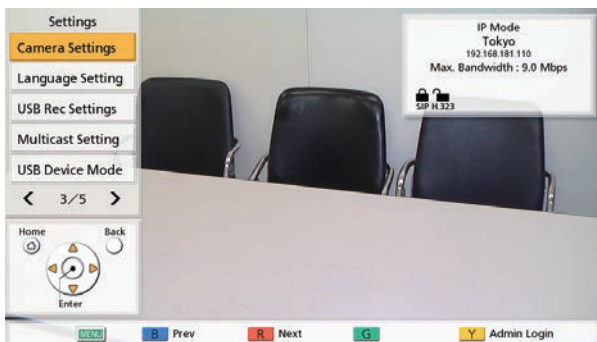
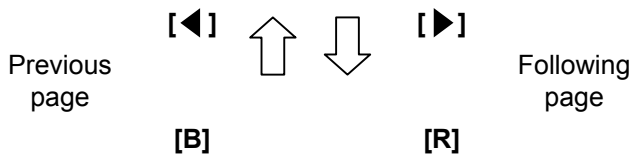

- ⑪ **Camera Settings:**
Sets the camera at your own site (Page 131).
- ⑫ **Language Setting:**
Sets the display language (Page 131).
- ⑬ **USB Rec Settings:**
Sets the recording mode, or starts and stops recording when the unit is idle (Page 132).
- ⑭ **Multicast Setting:**
Sets the multicast feature (Page 175).
- ⑮ **USB Device Mode:**
Changes the USB operation mode and sets the image quality in USB Device Mode (Page 132).

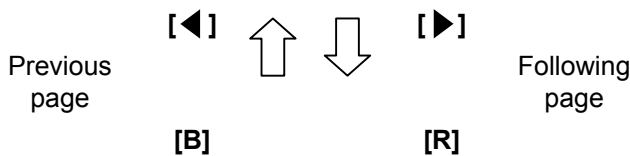

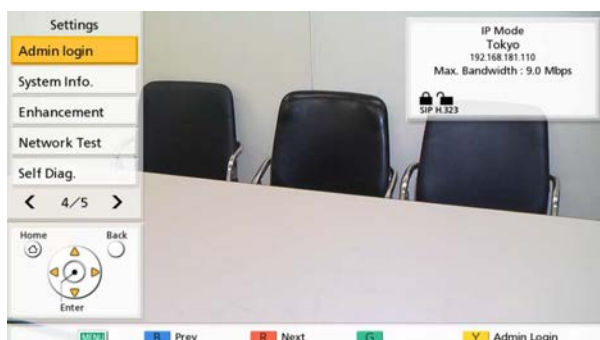

- ⑩ Admin login:
Shifts to the settings screen for the administrator menu (Page 136).
- ⑪ System Info.:
You can display the setting information of the main unit (Page 133).
- ⑫ Enhancement:
You can check the features that have been enabled due to the software enhancement feature (Page 133).
- ⑬ Network Test:
You can specify an IP address for checking the network connection (Page 134).
- ⑭ Self Diag.:
You can check the video and audio being sent to other parties from your own site (Page 134).

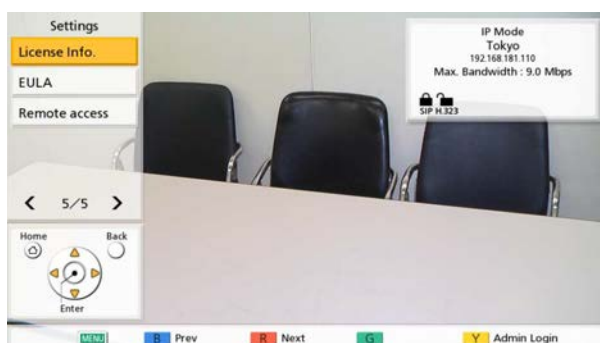
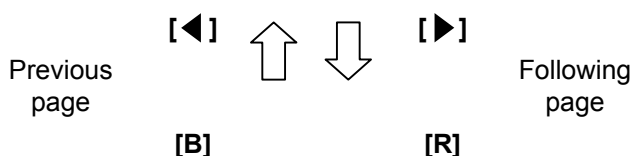

- ⑮ License Info.:
You can display information about licences and open source software (Page 135).
- ⑯ EULA:
You can display information about the licence agreement (Page 135).
- ⑰ Remote access:
Performs the operations so that dealers can carry out maintenance remotely (Page 135).

3. Use [▲][▼] to select an item to set, and press [ENTER].
 - The selected screen is displayed. Perform settings following the descriptions of each screen (① through ⑰).
4. Press [Home].
 - The Home screen is displayed.

Note

- "MIC Setting" is not displayed for the KX-VC1000.
- When using a KX-VC1000 that has not been expanded for 4 Point Built-in MCU support, "MCU Settings" is not displayed.

Setting the Unit Name

1. Select **"System Settings"** and press **[ENTER]**.
 - The unit name setting screen is displayed.
2. Enter a unit name (up to 24 characters) (Page 190).
3. Press **[G]**.
 - A dialogue box to confirm the saving of settings is displayed.
4. Use **[◀][▶]** to select **"Yes"** and press **[ENTER]**.
 - The system settings screen is displayed.

Setting the Date and Time

1. Select **"Set Date/Time"** and press **[ENTER]**.
 - The date/time settings screen is displayed.
2. Use **[▲][▼]** to select the item and input information.
 - Enter the year (4 digits), month (1–2 digits), day (1–2 digits), time (24 hour display), and select the date format (Month/Day/Year, Day/Month/Year, Year/Month/Day) and hour display format (12h/24h).
3. Press **[G]**.
 - A dialogue box to confirm the saving of settings and system restart after saving is displayed.
4. Use **[◀][▶]** to select **"Yes"** and press **[ENTER]**.
 - The system will automatically restart to reflect changes to system settings.

Making Network Settings

Note

- The following items are displayed over 3 pages. If you are not entering text, you can move to the next or previous screen by pressing **[R]** or **[B]**, respectively.
- When changing settings, press **[G]** on the screen where the change was made to save the settings.
- You can use the administrator menu to hide the network settings screen (Page 153).

Setting LAN1

Note

- For the KX-VC1000/KX-VC1300, **"IP Address (LAN 1)"** (setting), **"IP Address (LAN 1)"**, and **"Subnet mask (LAN 1)"** are respectively displayed as **"IP Address"** (setting), **"IP Address"**, and **"Subnet mask"**.
1. Select **"Network Settings"** and press **[ENTER]**.
 - The network settings screen is displayed.
 2. Use **[▲][▼]** to select the following items for input:
 - "IP Address (LAN 1)"**(setting): Use **[◀][▶]** to select whether the IP address information for this unit (**"IP Address (LAN 1)"**, **"Subnet mask (LAN 1)"**, **"Default Gateway"**) will be obtained automatically from a DHCP server or will be set manually.
 - **"Auto"** (default): Obtain the IP address information automatically.
 - **"Manual"**: Set the IP address information manually.

Note

- Even if you have selected **"Auto"**, you still may not be able to acquire an IP address due to problems such as network congestion. In this case, **"Address is not assigned"** is displayed in the upper right of the Home screen. Contact your network administrator.

"IP Address (LAN 1)": Enter the IP address of the unit.

"Subnet mask (LAN 1)": Enter the subnet mask.

"Default Gateway": Enter the IP address of the default gateway.

Note

- **"IP Address (LAN 1)"**, **"Subnet mask (LAN 1)"**, and **"Default Gateway"** can be entered only if **"IP Address (LAN 1)"** (setting) is set to **"Manual"**.
- If the value for **"IP Address (LAN 1)"**, **"Subnet mask (LAN 1)"**, or **"Default Gateway"** contains 1 or 2 digits numbers, enter these numbers as they are. Do not enter like [.001].
 Example: The IP address is [192.168.0.1].
 - Correct entry: [192.168.0.1]
 - Wrong entry: [192.168.000.001]

"DNS Server": Use **[◀][▶]** to select whether the IP address information for the DNS servers (**"Primary DNS Server"**, **"Secondary DNS**

Server") will be obtained automatically from a DHCP server or will be set manually.

- **"Auto"** (default): Obtain the IP address information automatically.
- **"Manual"**: Set the IP address information manually.

Note

- To select **"Auto"**, **"IP Address (LAN 1)"** (setting) must be set to **"Auto"**.
- The DNS server setting is necessary to use the following features.
 - Call by specifying the host name
 - Setting the SIP server or gatekeeper address by host name
 - Checking for software updates
 - Downloading the latest version over the network

"Primary DNS Server": Enter the IP address of the primary DNS server.

"Secondary DNS Server": Enter the IP address of the secondary DNS server.

Note

- **"Primary DNS Server"** and **"Secondary DNS Server"** can be entered only if **"DNS Server"** is set to **"Manual"**.
- If the value for **"Primary DNS Server"** or **"Secondary DNS Server"** contains 1 or 2 digits numbers, enter these numbers as they are. Do not enter like [.001].
Example: The IP address is [192.168.0.1].
 - Correct entry: [192.168.0.1]
 - Wrong entry: [192.168.000.001]

"LAN Mode (LAN 1)": Press [ENTER] and use [▲][▼] to select the LAN mode.

- **"1 Gbps (Auto)"**: Negotiates with the other party to determine the LAN mode. The maximum setting is 1 Gbps (full duplex).
- **"1 Gbps (Fix)"**: Fixes the LAN mode to 1 Gbps (full duplex).
- **"100 Mbps (Auto)"** (default): Negotiates with the other party to determine the LAN mode. The maximum setting is 100 Mbps (full duplex).
- **"100 Mbps (Fix)"**: Fixes the LAN mode to 100 Mbps (full duplex).
- **"10 Mbps (Fix)"**: Fixes the LAN mode to 10 Mbps (full duplex).

Note

- This setting is only displayed for the KX-VC2000.

- Match settings according to the hub or router to be connected.
- When **"10 Mbps (Fix)"** is set, set the **"Max. Bandwidth"** of **"Call set up"** to 10 Mbps or lower (Page 122).

3. If the settings for LAN1 are changed: Press [G].

- A dialogue box to confirm the saving of settings is displayed. Save the settings.

To set IPv6: Press [R].

- The second page is displayed.

To set LAN2: Press [R] twice, and then proceed to step 6.

Setting IPv6

Note

- For the KX-VC1000/KX-VC1300, **"IPv6 (LAN 1)"**, **"IPv6 Address (LAN 1)"** (setting), **"IPv6 Address (LAN 1)"** and **"Prefix length (LAN 1)"** are respectively displayed as **"IPv6"**, **"IPv6 Address"**, and **"Prefix length"**.

4. Use [▲][▼] to select the following items for input: **"IPv6 (LAN 1)"**: Select **"ON"** or **"OFF"** (default).

Note

- When **"ON"** is selected, both the IPv4 address and IPv6 address will be displayed on the unit information screen. On the upper right of the home screen, only the IPv4 address is displayed.

"IPv6 Address (LAN 1)" (setting): Select whether the IPv6 address will be obtained automatically or will be set manually.

- **"Auto (SLAAC)"** (default): Automatically obtains IP address information from the router.
- **"Auto (DHCP)"**: Automatically obtains IP address information from the DHCP server.
- **"Manual"**: IP address information is set manually.

Note

- When **"Auto (DHCP)"** is set, the default gateway address is obtained from the RA (router advertisement).
- Even if **"Auto (SLAAC)"** or **"Auto (DHCP)"** is set, in some cases the IP address information cannot be obtained

due to network failures or other occurrences. In such cases, the IPv6 address is displayed as "-" on the unit information screen. Contact your network administrator.

"IPv6 Address (LAN 1)": Enter this unit's IPv6 address.

"Prefix length (LAN 1)": Enter the prefix length of the IPv6 address.

"Default Gateway (IPv6)": Enter the IPv6 address of the default gateway for IPv6.

Note

- **"IPv6 Address (LAN 1)"** and **"Prefix length (LAN 1)"** can only be input when **"IPv6 Address (LAN 1)"** (setting) is set to **"Manual"**.
- For the input format for **"IPv6 Address (LAN 1)"** and **"Default Gateway (IPv6)"**, refer to Page 47.
- For **"IPv6 Address (LAN 1)"**, set your network's global address.

"Primary DNS Server (IPv6)": Enter the IPv6 address of the primary DNS server for IPv6.

"Secondary DNS Server (IPv6)": Enter the IPv6 address of the secondary DNS server for IPv6.

Note

- For the input format for **"Primary DNS Server (IPv6)"** and **"Secondary DNS Server (IPv6)"**, refer to Page 47.

5. If the settings for IPv6 are changed: Press [G].
 - A dialogue box to confirm the saving of settings is displayed. Save the settings.
 To set LAN2: Press [R].
 - The second page is displayed.

Making LAN2 Settings (KX-VC1600/KX-VC2000)

6. Use [▲][▼] to select the following items for input:
 - "LAN 2":** select **"ON"** or **"OFF"** (default) for LAN2.
 - "IP Address (LAN 2)":** Input the IP address for LAN2.
 - "Subnet mask (LAN 2)":** Input the subnet mask for LAN2.

Note

- If the value for **"IP Address (LAN 2)"** or **"Subnet mask (LAN 2)"** contains 1 or 2 digit numbers, enter these numbers as they are. Do not enter like [.001]. Example: The IP address is [192.168.0.1].
 - Correct entry: [192.168.0.1]

- Wrong entry: [192.168.000.001]

"IPv6 (LAN 2)": Select **"ON"** or **"OFF"** (default).

"IPv6 Address (LAN 2)": Enter the LAN2 IPv6 address.

"Prefix length (LAN 2)": Enter the prefix length of the IPv6 address.

Note

- When **"IPv6 (LAN 1)"** is set to **"OFF"** and **"IPv6 (LAN 2)"** is set to **"ON"**, to use the host name to set **"SIP Server Address"** of **"SIP Settings"** or **"Gatekeeper Address"** of **"H.323 Settings"**, set **"Primary DNS Server (IPv6)"** and **"Secondary DNS Server (IPv6)"** in step 4. Then, in steps 7–12, set routing for communication with the DNS server.
- For the input format for **"IPv6 Address (LAN 2)"**, refer to Page 47.
- For **"IPv6 Address (LAN 2)"**, set your network's global address.
- If **"ON"** is not set for **"LAN 2"**, **"Routing Settings"** will not be displayed. Once **"LAN 2"** is set to **"ON"**, press [G] to save the settings and close the setting screen. Then, select **"Network Settings"** and set the routing.

Routing settings for LAN2 (KX-VC1600/ KX-VC2000)

7. Use [▲][▼] to select **"Routing Settings"** and press [ENTER].
 - The routing list screen is displayed.
8. Use [▲][▼] to select **"Not Registered"**.
9. Press [B].
 - The routing settings screen is displayed.
10. Use [▲][▼] to select the following items for input:
 - "IP Address Format":** Specifies whether an IPv4 address or IPv6 address will be used.
 - "Destination":** Input the IP address of the other party to communicate with using LAN2.
 - "Subnet mask":** Input the subnet mask of the other party to communicate with using LAN2.
 - "Prefix length":** Enter the prefix length for the IPv6 address of the other party communicating using LAN2.
 - "Gateway":** Input the gateway address for communication with other parties that have been set.

Note

- **"Subnet mask"** can only be set when **"IPv4"** is set for **"IP Address Format"**.
- **"Prefix length"** can only be set when **"IPv6"** is set for **"IP Address Format"**.
- If **"IPv4"** is set for **"IP Address Format"**, and **"Destination"**, **"Subnet mask"**, or **"Gateway"** contains 1 or 2 digit numbers, enter these numbers as they are. Do not enter like [.001].
Example: The IP address is [192.168.0.1].
 - Correct entry: [192.168.0.1]
 - Wrong entry: [192.168.000.001]
- For the input format for **"Destination"** and **"Gateway"** when **"IPv6"** is set for **"IP Address Format"**, refer to Page 47.

"LAN Mode (LAN 2)": Press [ENTER] and use [▲][▼] to select the LAN mode.

- **"1 Gbps (Auto)":** Negotiates with the other party to determine the LAN mode. The maximum setting is 1 Gbps (full duplex).
- **"1 Gbps (Fix)":** Fixes the LAN mode to 1 Gbps (full duplex).
- **"100 Mbps (Auto)"** (default): Negotiates with the other party to determine the LAN mode. The maximum setting is 100 Mbps (full duplex).
- **"100 Mbps (Fix)":** Fixes the LAN mode to 100 Mbps (full duplex).
- **"10 Mbps (Fix)":** Fixes the LAN mode to 10 Mbps (full duplex).

Note

- **"LAN Mode (LAN 2)"** is not available if **"LAN 2"** is set to **"OFF"** in step 6.
- This setting is only displayed for the KX-VC2000.
- Match settings according to the hub or router to be connected.
- When **"10 Mbps (Fix)"** is set, set the **"Max. Bandwidth"** of **"Call set up"** to 10 Mbps or lower (Page 122).

11. Press [G].

- A dialogue box to confirm the saving of settings is displayed.

12. Use [◀][▶] to select **"Yes"** and press [ENTER].

- The routing list screen is displayed.

Note

- To continue setting another routing, repeat steps 8–12.

- The input **"Destination"** is converted to a network address and then used. There is no need to register multiple destination IP addresses that have the same network address.

13. Press [BACK].

- The system settings screen is displayed.

Making Connection Settings

Note

- You can use the administrator menu to hide the connection settings screen (Page 153).

1. Select **"Call set up"** and press [ENTER].

- The connection settings screen is displayed.

2. Use [▲][▼] to select the following items for input:

- The following items are displayed over 3 pages. To view all the items, press [R] to move to the next page, and press [B] to move to the previous page.

Note

- You must save the settings separately for each screen on which you changed the settings.
- When **"SIP"** is set to **"OFF"** on the call type settings screen (Page 143), **"Encryption (SIP)"** cannot be set.
- When **"H.323"** is set to **"OFF"** on the call type settings screen (Page 143), **"Encryption (H.323)"** cannot be set.

"Answer Mode": Use [◀][▶] to select how to answer video conference calls (**"Manual"** [default], **"Auto"**, or **"Forced Answer"**) (Page 63).

"More than one incoming call": Use [◀][▶] to select whether to accept calls from Sub Sites to make video conferences of more than 2 parties.

- **"ON"** (default): Allow calls with more than 2 parties.
- **"OFF"**: Do not allow calls to have more than 2 parties.

Note

- For sites operating as "Main Sites" in multiple-party video conference calls using the built-in MCU, select **"ON"**.
- When using a KX-VC1000 that has not been expanded for 4 Point Built-in MCU support, **"More than one incoming call"** is not displayed.

"Max. Bandwidth": Press [ENTER] and use [▲] [▼] to select the maximum allowed bandwidth to be used (**256 kbps–24 Mbps**) (default: **9.0 Mbps**).

Note

- Except for the KX-VC2000, settings from 256 kbps to 18 Mbps are available.
- Even if 24 Mbps is selected, the maximum bandwidth for transmission between 2 parties is 18 Mbps (KX-VC2000).

"Max. Bandwidth Per Site (LAN 1)": Press [ENTER], and then use [▲][▼] to select the maximum bandwidth per site ("**256 kbps**" - "**18 Mbps**", or "**Not Specified**") (default: "**Not Specified**").

"Max. Bandwidth Per Site (LAN 2)" (KX-VC1600/KX-VC2000): Press [ENTER], and then use [▲] [▼] to select the maximum bandwidth per site ("**256 kbps**" - "**18 Mbps**", or "**Not Specified**") (default: "**Not Specified**").

Note

- For the KX-VC1300, "**Max. Bandwidth Per Site (LAN 1)**" is displayed as "**Max. Bandwidth Per Site**".
- When using a KX-VC1000 that has been expanded for 4 Point Built-in MCU support, "**Max. Bandwidth Per Site (LAN 1)**" is displayed as "**Max. Bandwidth Per Site**". If the feature is not expanded, this item is not displayed.
- During a 2-party call, the bandwidth of the site with the lowest-set maximum bandwidth is applied, and in a multiple-party call, bandwidth is applied according to each site's maximum bandwidth and the number of connected sites. However, when the value of "**Max. Bandwidth Per Site**" (excluding "**Not Specified**") is smaller, the value of "**Max. Bandwidth Per Site**" is applied as the maximum bandwidth.
- You cannot select a value that is higher than the maximum bandwidth set by the dealer. For details, contact your dealer.

"Dual stream": Use [◀][▶] to select whether dual stream communication is enabled.

- **"ON"** (default): Enables dual stream communication.
- **"OFF"** Disables dual stream communication.

"Send Content Method": Press [ENTER], and then use [▲][▼] to select the contents sending method when dual stream is enabled.

- **"Auto"** (default): Automatically selects either dual stream or single stream.
- **"Single stream"**: Fixed to single stream.

"Encode rate": Press [ENTER] and use [▲][▼] to select the encoding rate ratio for the main stream and sub stream.

- **"Main (30%) < Sub (70%)"**: Prioritise the sub stream during calls.
- **"Main (50%) = Sub (50%)"** (default): Use the same priorities during calls.
- **"Main (70%) > Sub (30%)"**: Prioritise the main stream during calls.

"Video Quality (Main Camera)"/"Video Quality (Sub Camera)": Press [ENTER] and use [▲][▼] to select between prioritising smooth movement or image quality for video.

- **"Motion"** (default): Prioritise smooth movement.
- **"Sharpness"**: Prioritise image quality.
- **"Resolution (Max. Full HD)"**: Fixes the resolution to full HD or the other party's maximum resolution, whichever is lower, regardless of the communication bandwidth.
- **"Resolution (Max. HD)"**: Fixes the resolution to HD or the other party's maximum resolution, whichever is lower, regardless of the communication bandwidth.

"Video Quality (PC)": Press [ENTER] and use [▲][▼] to select between prioritising smooth movement or image quality for video.

- **"Motion"**: Prioritise smooth movement.
- **"Sharpness"** (default): Prioritise image quality.

"Quality of Service": Use [◀][▶] to select between prioritising sound or images when bandwidth is low or the network is congested.

- **"Audio"** (default): When bandwidth is low sound quality is prioritised, and when the network is congested sound disturbance is reduced.
- **"Video"**: Even when bandwidth is low or the network is congested, image quality is prioritised.

"Default MIC Mute set (Make Call)": Use [◀] [▶] to select whether the microphone will be muted or not when making a call to start a video conference.

- **"ON"**: The microphone will be muted.
- **"OFF"** (default): The microphone will not be muted.

"Default MIC Mute set (Incoming)": Use [◀] [▶] to select whether to mute the microphone(s) at the start of a received video conference call.

- **"ON"**: Mutes the microphone(s).
 - **"OFF"** (default): Does not mute the microphone(s).
- "Call Limit time"**: Enter the maximum length of time for the duration of a video conference call (in hours and minutes).

Note

- If you set 0 hours 0 minutes (default), the call time is unlimited.
- If the duration of a video conference call exceeds the specified length of time, the call will be automatically disconnected.

"MIC detection": Use [◀][▶] to select whether to enable connection status detection for Boundary Microphones or a headset.

- **"ON"** (default): Boundary Microphone/headset detection is enabled.
- **"OFF"**: Boundary Microphone/headset detection is disabled.

Note

- When Boundary Microphones/headsets are not being used, set this to **"OFF"**.

"Network Connection Status": Use [◀][▶] to select whether to display the network status indication.

- **"ON"** (default): Displays the network status indication.
- **"OFF"**: Hides the network status indication.

"Active call Menu": Use [◀][▶] to select whether to display the guide when a video conference call begins.

- **"ON"** (default): Displays the guide.
- **"OFF"**: Hides the guide.

"Noise reduction": Use [◀][▶] to select whether to enable noise reduction when a video conference call begins.

- **"ON"**: Enables noise reduction.
- **"OFF"** (default): Disables noise reduction.

Note

- **"Noise reduction"** is not displayed for the KX-VC1000.

"Encryption (SIP)": Use [◀][▶] to select whether to enable encryption.

- **"ON"**: Encryption is enabled.
- **"OFF"** (default): Encryption is disabled.

"Encryption (H.323)": Press [ENTER] and use [▲][▼] to select whether to enable encryption.

- **"Best effort"**: Enables encrypted communication when the other party has

"ON" set for encrypted communication. When **"OFF"** is set, communication is performed without encryption.

- **"ON"**: Encryption is enabled.
- **"OFF"** (default): Encryption is disabled.

"Encryption (NAT Traversal)": Use [◀][▶] to select whether encrypted communication is enabled.

- **"ON"**: Enables encrypted communication.
- **"OFF"** (default): Disables encrypted communication.

Note

- **"Encryption (SIP)"** and **"Encryption (H.323)"** are displayed when IP mode or IP/NAT Traversal mode is being used.
- **"Encryption (NAT Traversal)"** is displayed when NAT Traversal mode or IP/NAT Traversal mode is being used.
- Be careful when changing encryption settings because doing so may cause you to become unable to communicate with other parties.
- Be aware that if encryption is disabled, eavesdropping might be possible on networks that are not secured against such actions.
- If you cannot specify a value for **"Encryption (SIP)"/"Encryption (H.323)"/"Encryption (NAT Traversal)"** because the setting is unavailable, contact your network administrator.

"Server Port": Press [ENTER] and use [▲][▼] to select the port to use when connecting using NAT Traversal Mode.

- **"Default"**: A normally-used port will be automatically selected.
- **"Alternate"** (default): Set when communication cannot be performed normally.

Note

- Displayed when **"Connection mode"** is set to **"NAT Traversal Mode"** or **"IP / NAT Traversal Mode"**.

"Transmission Band Control": Use [◀][▶] to select whether to enable transmission bandwidth control.

- **"ON"** (default): Enables transmission bandwidth control.
- **"OFF"**: Disables transmission bandwidth control.

Note

- If "OFF" is set, other communications that use the same network may be affected.

3. Press [G].

- A dialogue box to confirm the saving of settings is displayed.

4. Use [◀][▶] to select "Yes" and press [ENTER].

- The system settings screen is displayed.

Setting the MCU

Note

- When using a KX-VC1000 that has not been expanded for 4 Point Built-in MCU support, "MCU Settings" is not displayed in the system settings screen.

1. Select "MCU Settings" and press [ENTER].

- The settings screen of the built-in MCU is displayed.

2. Use [▲][▼] to select the following items for input:

- The following items are displayed over 2 pages. To view all the items, press [R] to move to the next page, and press [B] to move to the previous page.

"MCU Mode": Press [ENTER] and use [▲][▼] to select the MCU mode used when starting a video conference.

- "Discussion" (default): The same image is displayed for the main site and sub sites. This mode is suited to discussion-style conferences.
- "Presentation": The main site sees a composite image including the sub sites, and the sub sites see the image from the main site only. This mode is suited to lecture-style conferences.

"Screen Layout (Discussion)": Press [ENTER] and use [▲][▼] to select the screen layout for Discussion Mode.



- "Auto" (default): Automatically changes the layout depending on the number of parties joining a video conference call.
- "CP1" to "CP28": Sets the screen layout manually.

Note

- When "Auto" is selected, the layout changes automatically depending on the number of sites joining the conference.

Number of Sites	Layout Number
2	CP1
3-4	CP4
5-6	CP6
7-8	CP8
9	CP9
10	CP10
11-13	CP13
14-15	CP15
16	CP16
17-20	CP20
21	CP21
22-24	CP24

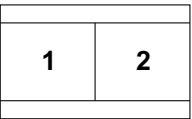
- The screen layout during a conference call can be selected from the following 15 patterns. The numbers in the layout configurations indicate each site's image display priority.

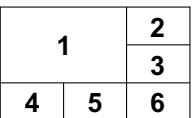
Layout Number	Layout Configuration
CP1	
CP2	
CP4	
CP6	

Layout Number	Layout Configuration																																				
CP8	<table border="1"> <tr> <td colspan="4">1</td> <td>2</td> </tr> <tr> <td colspan="4"></td> <td>3</td> </tr> <tr> <td colspan="4"></td> <td>4</td> </tr> <tr> <td>5</td> <td>6</td> <td>7</td> <td>8</td> <td></td> </tr> </table>	1				2					3					4	5	6	7	8																	
1				2																																	
				3																																	
				4																																	
5	6	7	8																																		
CP9	<table border="1"> <tr> <td>1</td> <td>2</td> <td>3</td> </tr> <tr> <td>4</td> <td>5</td> <td>6</td> </tr> <tr> <td>7</td> <td>8</td> <td>9</td> </tr> </table>	1	2	3	4	5	6	7	8	9																											
1	2	3																																			
4	5	6																																			
7	8	9																																			
CP10	<table border="1"> <tr> <td colspan="2">1</td> <td colspan="2">2</td> </tr> <tr> <td>3</td> <td>4</td> <td>5</td> <td>6</td> </tr> <tr> <td>7</td> <td>8</td> <td>9</td> <td>10</td> </tr> </table>	1		2		3	4	5	6	7	8	9	10																								
1		2																																			
3	4	5	6																																		
7	8	9	10																																		
CP13	<table border="1"> <tr> <td colspan="2">1</td> <td>2</td> <td>3</td> </tr> <tr> <td colspan="2"></td> <td>4</td> <td>5</td> </tr> <tr> <td>6</td> <td>7</td> <td>8</td> <td>9</td> </tr> <tr> <td>10</td> <td>11</td> <td>12</td> <td>13</td> </tr> </table>	1		2	3			4	5	6	7	8	9	10	11	12	13																				
1		2	3																																		
		4	5																																		
6	7	8	9																																		
10	11	12	13																																		
CP15	<table border="1"> <tr> <td colspan="4">1</td> <td colspan="2">2</td> </tr> <tr> <td colspan="4"></td> <td colspan="2">3</td> </tr> <tr> <td>4</td> <td>5</td> <td>6</td> <td>7</td> <td>8</td> <td>9</td> </tr> <tr> <td>10</td> <td>11</td> <td>12</td> <td>13</td> <td>14</td> <td>15</td> </tr> </table>	1				2						3		4	5	6	7	8	9	10	11	12	13	14	15												
1				2																																	
				3																																	
4	5	6	7	8	9																																
10	11	12	13	14	15																																
CP16	<table border="1"> <tr> <td>1</td> <td>2</td> <td>3</td> <td>4</td> </tr> <tr> <td>5</td> <td>6</td> <td>7</td> <td>8</td> </tr> <tr> <td>9</td> <td>10</td> <td>11</td> <td>12</td> </tr> <tr> <td>13</td> <td>14</td> <td>15</td> <td>16</td> </tr> </table>	1	2	3	4	5	6	7	8	9	10	11	12	13	14	15	16																				
1	2	3	4																																		
5	6	7	8																																		
9	10	11	12																																		
13	14	15	16																																		
CP20	<table border="1"> <tr> <td colspan="2">1</td> <td colspan="2">2</td> </tr> <tr> <td>3</td> <td>4</td> <td>5</td> <td>6</td> </tr> <tr> <td>7</td> <td>8</td> <td>9</td> <td>10</td> </tr> <tr> <td>11</td> <td>12</td> <td>13</td> <td>14</td> </tr> <tr> <td>15</td> <td>16</td> <td>17</td> <td>18</td> </tr> <tr> <td>19</td> <td>20</td> <td></td> <td></td> </tr> </table>	1		2		3	4	5	6	7	8	9	10	11	12	13	14	15	16	17	18	19	20														
1		2																																			
3	4	5	6																																		
7	8	9	10																																		
11	12	13	14																																		
15	16	17	18																																		
19	20																																				
CP21	<table border="1"> <tr> <td colspan="4">1</td> <td>2</td> <td>3</td> </tr> <tr> <td colspan="4"></td> <td>4</td> <td>5</td> </tr> <tr> <td colspan="4"></td> <td>6</td> <td>7</td> </tr> <tr> <td colspan="4"></td> <td>8</td> <td>9</td> </tr> <tr> <td>10</td> <td>11</td> <td>12</td> <td>13</td> <td>14</td> <td>15</td> </tr> <tr> <td>16</td> <td>17</td> <td>18</td> <td>19</td> <td>20</td> <td>21</td> </tr> </table>	1				2	3					4	5					6	7					8	9	10	11	12	13	14	15	16	17	18	19	20	21
1				2	3																																
				4	5																																
				6	7																																
				8	9																																
10	11	12	13	14	15																																
16	17	18	19	20	21																																

Layout Number	Layout Configuration																																			
CP24	<table border="1"> <tr> <td>1</td> <td>2</td> <td>5</td> <td>6</td> </tr> <tr> <td colspan="2"></td> <td>7</td> <td>8</td> </tr> <tr> <td>3</td> <td>4</td> <td>9</td> <td>10</td> </tr> <tr> <td colspan="2"></td> <td>11</td> <td>12</td> </tr> <tr> <td>13</td> <td>14</td> <td>15</td> <td>16</td> </tr> <tr> <td>17</td> <td>18</td> <td>19</td> <td>20</td> </tr> <tr> <td>21</td> <td>22</td> <td>23</td> <td>24</td> </tr> </table>	1	2	5	6			7	8	3	4	9	10			11	12	13	14	15	16	17	18	19	20	21	22	23	24							
1	2	5	6																																	
		7	8																																	
3	4	9	10																																	
		11	12																																	
13	14	15	16																																	
17	18	19	20																																	
21	22	23	24																																	
CP25	<table border="1"> <tr> <td>1</td> <td>2</td> <td>3</td> <td>4</td> <td>5</td> </tr> <tr> <td>6</td> <td>7</td> <td>8</td> <td>9</td> <td>10</td> </tr> <tr> <td>11</td> <td>12</td> <td>13</td> <td>14</td> <td>15</td> </tr> <tr> <td>16</td> <td>17</td> <td>18</td> <td>19</td> <td>20</td> </tr> <tr> <td>21</td> <td>22</td> <td>23</td> <td>24</td> <td>25</td> </tr> </table>	1	2	3	4	5	6	7	8	9	10	11	12	13	14	15	16	17	18	19	20	21	22	23	24	25										
1	2	3	4	5																																
6	7	8	9	10																																
11	12	13	14	15																																
16	17	18	19	20																																
21	22	23	24	25																																
CP28	<table border="1"> <tr> <td colspan="2">1</td> <td>2</td> <td>3</td> <td>4</td> </tr> <tr> <td colspan="2"></td> <td>5</td> <td>6</td> <td>7</td> </tr> <tr> <td colspan="2"></td> <td>8</td> <td>9</td> <td>10</td> </tr> <tr> <td>11</td> <td>12</td> <td>13</td> <td>14</td> <td>15</td> </tr> <tr> <td>16</td> <td>17</td> <td>18</td> <td>19</td> <td>20</td> </tr> <tr> <td>21</td> <td>22</td> <td>23</td> <td>24</td> <td>25</td> </tr> <tr> <td>26</td> <td>27</td> <td>28</td> <td></td> <td></td> </tr> </table>	1		2	3	4			5	6	7			8	9	10	11	12	13	14	15	16	17	18	19	20	21	22	23	24	25	26	27	28		
1		2	3	4																																
		5	6	7																																
		8	9	10																																
11	12	13	14	15																																
16	17	18	19	20																																
21	22	23	24	25																																
26	27	28																																		

"Screen Layout (Presentation)": Press [ENTER] and use [▲][▼] to select the screen layout for Presentation Mode.

- **"Auto"** (default): Automatically changes the layout depending on the number of parties joining a video conference call.
- **"CP1" to "CP28"**: Sets the screen layout manually.

Note

- When **"Auto"** is selected, the layout changes automatically depending on the number of sites joining the conference.

Number of Sites	Layout Number
2	CP1
3	CP2
4-5	CP4
6-7	CP6
8-9	CP8
10	CP9
11	CP10
12-14	CP13
15-16	CP15
17	CP16
18-21	CP20

Number of Sites	Layout Number
22	CP21
23-24	CP24

"Main Position (Discussion)": Press [ENTER] and use [▲][▼] to select the display method for the main position.

- **"Local Site"** (default): Displays your own site.
- **"Voice Activation 1"**: The site with the loudest volume is automatically displayed as the main display.
- **"Voice Activation 2 (Local Site)"**: Your own site's image is displayed as the main display, and the site with the loudest volume at the time is displayed as display priority 2.

"Video switch time frame": Use [◀][▶] to select the time the screen's display is fixed when the display is controlled according to audio (1 to 20 seconds, default: 10 seconds).

"Site name display": Use [◀][▶] to select whether to display site names when the display is split into multiple screens.

- **"ON"** (default): Display site names.
- **"OFF"**: Do not display site names.

Note

- For images displayed using HDMI 1 at the main site, you can display the name of each site on the layout screen. Note, however, that when using PwithP or SideBySide for camera or content layout, the site name is not displayed even when using HDMI 1 (Page 150).
- When using presentation mode, site names are displayed in the composite image of sub sites.

"Local Camera Display of MCU Site": Select whether to display an image of the main site as the composite image in discussion mode using [◀][▶].

- **"ON"** (default): Displays the image of the main site.
- **"OFF"**: Does not display the image of the main site.

"Camera control transmitting": Use [◀][▶] to select whether to allow Sub Sites to operate the camera of main display site.

- **"ON"**: Allow camera operation by Sub Sites.
- **"OFF"** (default): Do not allow camera operation by Sub Sites.

"DTMF for Content Sharing": Use [◀][▶] to select whether to allow Sub Sites to share contents using remote control operations.

- **"ON"** (default): Allow Sub Sites to perform operations using the remote control.
- **"OFF"**: Do not allow operations by Sub Sites using the remote control.

Note

- When "ON" is set, content sharing can be controlled using the [PC], [CAMERA SUB], and [CAMERA MAIN] buttons, as well as the numeric keypad (*10: Start sharing, *11: Stop sharing).

"DTMF layout change": Use [◀][▶] to select whether other parties can use remote control operations to perform screen layout change operations.

- **"ON"**: Enable operations by Sub Sites using the remote control.
- **"OFF"** (default): Disable remote control operations by Sub Sites.

"Auto move to CP1": Use [◀][▶] to select whether the function that switches the screen layout to CP1 when content sharing is started is enabled or not.

- **"ON"** (default): Switching to CP1 is enabled.
- **"OFF"**: Switching to CP1 is disabled.

"Other Site's Audio": Press [ENTER] and use [▲][▼] to select the mode to combine audio from Main Site with the audio from the other site.

- **"Mix (Auto)"** (default): Audio from the loudest 4 sites is automatically mixed together.
- **"Mute"**: Mutes the audio of Sub Sites. Only the audio of the Main Site is output.

"Display far site's Mute icon": Use [◀][▶] to select whether the Sub Site audio status icon is displayed.

- **"ON"** (default): The audio status icon is displayed.
- **"OFF"**: The audio status icon is not displayed.

"Display Presentation Mode icon": Use [◀][▶] to select whether an icon is displayed to indicate that the MCU mode is Presentation Mode.

- **"ON"** (default): The presentation icon will be displayed.
- **"OFF"**: The presentation icon will not be displayed.

"Secondary Bandwidth Selection": Press [ENTER] and use [▲][▼] to select two types of communication group thresholds.

- **"Not Specified"**: Bandwidth threshold not considered.
 - **"256 kbps or more" – "2.0 Mbps or more"** (default: **"768 kbps or more"**): Consider bandwidth to determine the two types of communication group thresholds.
3. Press **[G]**.
 - A dialogue box to confirm the saving of settings is displayed.
 4. Use **[◀][▶]** to select **"Yes"** and press **[ENTER]**.
 - The system settings screen is displayed.

Setting One-touch Connection Numbers

Set the addresses or profiles assigned to the one-touch connection numbers (1 to 5) displayed on the home screen.

1. Select **"One-Touch Set."** and press **[ENTER]**.
 - The one-touch connection number settings screen is displayed.
 2. Use **[▲][▼]** to select **"Not Registered"**.
 3. Press **[B]**.
 - A dialogue box is displayed for selecting which kind of input method to reference.
- Note**
- When using a KX-VC1000 that has not been expanded for 4 Point Built-in MCU support, the contact list selection screen is displayed. Proceed to "When **"Contact list"** is selected:" in step 4.
4. Use **[▲][▼]** to select the reference source, **"Contact list"** or **"Profile"** and press **[ENTER]**.

When **"Contact list"** is selected:
The contact list selection screen is displayed.

1. Use **[▲][▼]** to select the other party to register, and press **[ENTER]**.
 - The one-touch connection number settings screen is displayed.

When **"Profile"** is selected:
The profile list reference screen is displayed.

1. Use **[▲][▼]** to select the group name you want to register and press **[ENTER]**.
 - The one-touch connection number settings screen is displayed.
5. Press **[G]**.
 - A dialogue box to confirm the saving of settings is displayed.
6. Use **[◀][▶]** to select **"Yes"** and press **[ENTER]**.
 - The system settings screen is displayed.

Making Screen Standby Settings

When the remote control is not operated or a video conference call is not received for a specified length of time, the unit enters standby mode. You can set the length of time here.

1. Select **"Standby Setting"** and press **[ENTER]**.
 - The screen standby settings screen is displayed.
2. Enter the length of time (**0–99**) in minutes until the unit enters screen standby mode (default: **10**).

Note

- If you set **"0"**, the unit will not enter screen standby mode automatically. However, if you press the remote control's **[STANDBY]** button, the unit will enter screen standby mode even if **"0"** is set.
3. Press **[G]**.
 - A dialogue box to confirm the saving of settings is displayed.
 4. Use **[◀][▶]** to select **"Yes"** and press **[ENTER]**.
 - The system settings screen is displayed.

Making Sound Settings

1. Select **"Sound Settings"** and press **[ENTER]**.
 - The sound settings screen is displayed.
2. Use **[▲][▼]** to select the following items for input: **"Welcome Screen Vol."**: Press **[ENTER]** and use **[▲][▼]** to select the volume level (**"OFF"**, **"Low"**,

"Medium" [default] or "High") played at the start-up.

"Ringback Tone Vol.": Press [ENTER] and use [▲][▼] to select the volume level ("OFF", "Low", "Medium" [default] or "High") of an outgoing call ring.

"Ring Tone Vol.": Press [ENTER] and use [▲][▼] to select the volume level ("OFF", "Low", "Medium" [default] or "High") of an incoming call ring.

"Ringback Tone": Press [ENTER] and use [▲][▼] to select the calling sound pattern ("Pattern 1" to "Pattern 5") (default: "Pattern 1").

"Ring Tone": Press [ENTER] and use [▲][▼] to select the incoming call sound pattern ("Pattern 1" to "Pattern 5") (default: "Pattern 1").

"Default Sound Lev.": Use [◀][▶] to select the volume level (0–20) at the start of a video conference call (default: 16).

"Sound Pre-sets": Press [ENTER] and use [▲][▼] to select the tone ("More Highs", "Standard" [default], "More Lows", "Voice" or "Music") at the start of a video conference call.

Note

- You can listen to a sample of the following items by pressing [R].
 - "Welcome Screen Vol."
 - "Ringback Tone Vol."
 - "Ring Tone Vol."
 - "Ringback Tone"
 - "Ring Tone"
- A music note icon will be displayed to the right of the item being heard. Pressing [R] will stop the playing of the item being heard.

3. Press [G].
 - A dialogue box to confirm the saving of settings is displayed.
4. Use [◀][▶] to select "Yes" and press [ENTER].
 - The system settings screen is displayed.

Setting the MIC Position

You can specify where a Digital Boundary Microphone is conceptually positioned relative to the display. When sounds are transmitted to another party, they are played in accordance with the specified positions, which creates a stereo environment.

Note

- "MIC Setting" is not displayed in the system settings screen for the KX-VC1000.

Setting the MIC Position automatically

1. Select "MIC Setting" and press [ENTER].
 - The auto settings screen is displayed.

Note

- If the manual settings screen is displayed, press [B] to return to the auto settings screen.

2. Press [G].
 - A dialogue box to confirm the saving of settings is displayed.
3. Use [◀][▶] to select "Yes" and press [ENTER].
 - The system settings screen is displayed.

Note

- Depending on how many Digital Boundary Microphones are connected, the output settings differ as follows:
 - 2 or more Digital Boundary Microphones: Monaural output
 - 1 Digital Boundary Microphone: Stereo output
- When using Digital Boundary Microphones and an Analogue Boundary Microphone together, the output for all Boundary Microphones will be monaural.

Setting the MIC Position manually

1. Select "MIC Setting" and press [ENTER].
 - The auto settings screen is displayed.

Note

- If the manual settings screen is displayed, proceed to step 3.

2. Press [B].
 - The manual settings screen is displayed.
3. Use [▲][▼] to select the Digital Boundary Microphone you want to configure and press [ENTER].

4. Use [▲][▼] to select the Digital Boundary Microphone's relative position.
- "Left side"**: Sounds on left side are played.
- "Right side"**: Sounds on right side are played.
- "Center Mono"**: All sounds are played through both the left and right speakers at the same volume.
- "Center stereo"**: Sounds centred on the microphone are played through both the left and right speakers at the same volume.

Note

- When a Digital Boundary Microphone is set to **"Center stereo"**, make sure that it is placed with its connector facing the display.
- When using Digital Boundary Microphones and an Analogue Boundary Microphone together, the output settings differ as follows:
 - Digital Boundary Microphones: Manually set output
 - Analogue Boundary Microphone: Monaural output
- For the settings shown in the following diagrams, the left/right channels are displayed as viewed from the side of the main video camera.

Here are examples of the relative position of Digital Boundary Microphones.

When setting Digital Boundary Microphones in a row perpendicular to the display:

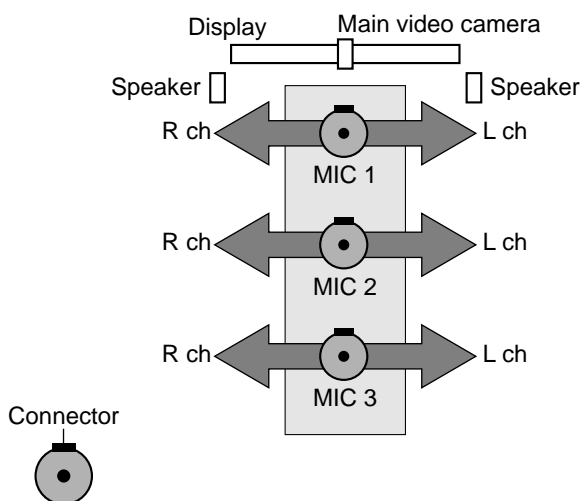

MIC 1: **"Center stereo"**
 MIC 2: **"Center stereo"**
 MIC 3: **"Center stereo"**

When setting Digital Boundary Microphones parallel with the display:

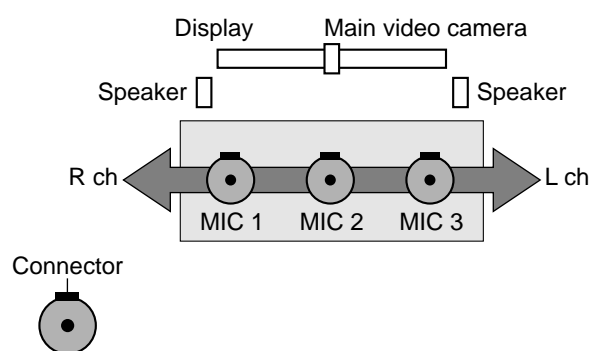

MIC 1: **"Right side"**
 MIC 2: **"Center Mono"**
 MIC 3: **"Left side"**

When setting Digital Boundary Microphones as follows:

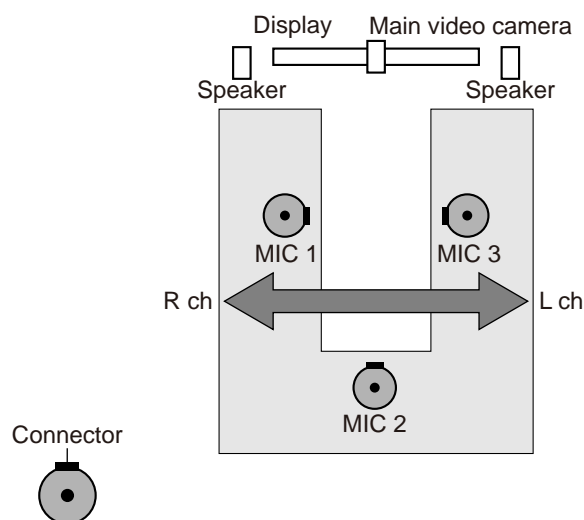

MIC 1: **"Right side"**
 MIC 2: **"Center Mono"**
 MIC 3: **"Left side"**

Note

- Make some noise near the Digital Boundary Microphone. "▶" is displayed to indicate which Digital Boundary Microphone picks up the noise.
- "▶" is not displayed when the Digital Boundary Microphone is mute.
- "▶" is not displayed when multiple Digital Boundary Microphones pick up the sound at the same time.

- When the Digital Boundary Microphone is mute, the sound made by pressing the MIC Mute button might make "▶" appear.

5. Press [G].

- A dialogue box to confirm the saving of settings is displayed.

6. Use [◀][▶] to select "Yes" and press [ENTER].

- The system settings screen is displayed.

Note

- Do not move Digital Boundary Microphones after completing settings. Otherwise the settings will not match the location of the Digital Boundary Microphone.

Making Remote Control Settings

You can specify a remote control ID from 1, 2, or 3 for both the remote control and the unit. The unit responds to signals from any remote control with the same remote control ID as itself. If you do not specify an ID, the unit responds to signals from all remote controls. You can confirm the remote control ID for the unit on the Home screen (Page 41).

1. Select "Remote Ctrl ID" and press [ENTER].

- The remote control settings screen is displayed.

2. Use [▲][▼] to select the following items for input:

"Remote ID enable": Use [◀][▶] to select "ON" or "OFF" (default).

- When "ON" is selected, you can set a specific remote control ID for the unit.
- When "OFF" is selected, the unit will respond to all remote controls.

"Remote control ID": Use [◀][▶] to select a remote control ID ("ID1" [default]/"ID2"/"ID3") for the unit.

"Check ID mismatch": Use [◀][▶] to select "ON" (default) or "OFF".

- When "ON" is selected, if the unit receives a signal from a remote control that has an ID different from the one specified on the Home screen, a warning is displayed. Follow the procedures on the screen to change the remote control ID.
- When "OFF" is selected, even if the unit receives a signal from a remote control that has

an ID different from the one specified, no warning is displayed on the Home screen.

Note

- If multiple remote controls with assigned IDs are being used close together, it is recommended that you select "OFF" for "Check ID mismatch".

3. Press [G].

- A dialogue box to confirm the saving of settings is displayed.

4. Use [◀][▶] to select "Yes" and press [ENTER].

5. When "Remote ID enable" is set to "ON":

The dialogue box for changing the ID of the remote control is displayed. Proceed to step 6.

Note

- While the dialogue box is displayed, video conference calls cannot be received.

When "Remote ID enable" is set to "OFF":

The system settings screen is displayed. Press [Home] to return to the Home screen.

6. Use the following procedure to change the ID of the remote control.

1. Press and hold [·] and [#] at the same time.
2. Within 2 seconds after you release the buttons, press the number (1 to 3) corresponding to the ID that you specified for "Remote control ID" in step 1.
 - 1: ID1
 - 2: ID2
 - 3: ID3

7. Press [ENTER].

- The dialogue box disappears and the remote control ID of the unit will be saved.

Note

- If the dialogue box does not disappear, repeat the procedure above, several times if necessary. If the dialogue box still does not disappear, turn the power off and then back on to cancel the settings. For details, contact your dealer.

Changing Video Camera Settings

1. Select **"Camera Settings"** and press [ENTER].
 - The video camera settings screen is displayed.
2. Use [▲][▼] to select the following items for input:
 - "CAM ctrl from remote site(s)"**: Use [◀][▶] to select whether to allow the other party to control your video camera.
 - **"ON"**: Allows the other party to control your video camera.
 - **"OFF"** (default): Prevents the other party from controlling your video camera.
 - "Direct Cam Ctrl during call"**: Use [◀][▶] to select whether camera operation by remote control is enabled during a video conference call.
 - **"ON"** (default): Allow camera operations using the remote control.
 - **"OFF"**: Do not allow camera operations using the remote control.
 - "Direct Cam Ctrl on Home Screen"**: Use [◀][▶] to select whether camera operation by remote control is enabled when not in a video conference call.
 - **"ON"** (default): Allow camera operations using the remote control.
 - **"OFF"**: Do not allow camera operations using the remote control.
 - "Pan Direction"**: Use [◀][▶] to select the direction in which the video camera will move when the buttons on the remote control are pressed.
 - **"Normal"** (default): The video camera will move in the left/right direction, as viewed from the video camera.
 - **"Reversed"**: The video camera will move in the left/right direction, as viewed from the subject.
 - "Remote control through function"**: Use [◀][▶] to select whether the camera or the unit will receive commands from the remote control.
 - **"ON"**: The camera will receive commands from the remote control.
 - **"OFF"** (default): The unit will receive commands from the remote control.

Note

- For software versions lower than 4.50, **"Remote control through function"** is displayed as **"FIX Cam's Remote Ctrl Rcvr"**.

- If a camera is not connected or depending on the model of the camera, the unit will receive commands from the remote control even if **"ON"** is selected.

"Layout change camera control": Use [◀][▶] to select whether the layout will change while the camera is being controlled.

- **"ON"**: The layout will change.
- **"OFF"** (default): The layout will not change.

3. Press [G].
 - A dialogue box to confirm the saving of settings is displayed.
4. Use [◀][▶] to select **"Yes"** and press [ENTER].
 - The system settings screen is displayed.

Making Language Settings

1. Select **"Language Setting"** and press [ENTER].
 - The language settings screen is displayed.
2. Press [ENTER] and use [▲][▼] to select the desired language.

Note

- The language you can select is as follows: **"English"**: English (default), **"Deutsch"**: German, **"Français"**: French, **"Italiano"**: Italian, **"Español"**: Spanish, **"Nederlands"**: Dutch, **"Português"**: Portuguese, **"日本語"**: Japanese, **"Русский язык"**: Russian, **"简体中文"**: Chinese, **"العربية"**: Arabic.
- When Chinese is selected, **"Arabic"** is displayed to select Arabic.

3. Press [ENTER].
4. Press [G].
 - A dialogue box to confirm the saving of settings is displayed.
5. Use [◀][▶] to select **"Yes"** and press [ENTER].
 - The system settings screen is displayed in the selected language.

Note

- If you accidentally choose the wrong language, follow the steps below to change the language setting.

1. Press [**Home**].
2. Press [**MENU**].
3. Press [**▼**] four times to select the fifth item from the top, press [**ENTER**].
4. Press [**▶**] twice.
 - The second page is displayed.
5. Press [**▼**] to select the second item from the top, press [**ENTER**].
 - The language settings screen is displayed.
6. Repeat the procedure from step 2.

Making Recording Settings

You can set the USB recording settings during calls, while idle, and during a multicast. You can also start and stop recording while idle.

Note

- You can make settings only when "**USB Rec**" in "**Security Settings**" is set to "**ON**".
- The screen recorded in KX-VC2000 differs from KX-VC1000/KX-VC1300/KX-VC1600. For details about recording, refer to "Using USB Recording Features (Page 183)".

To change settings

Note

- You cannot change settings while recording. The unit records according to the settings displayed on the settings screen while recording.
1. Select "**USB Rec Settings**" and press [**ENTER**].
 - The recording settings screen is displayed.
 2. Use [**▲**][**▼**] to select the following items for input.
"**Video Quality**": Press [**ENTER**] and use [**▲**][**▼**] to select "**High**", "**Medium**" (default), or "**Low**".
"**Dual Display Rec screen**": Press [**ENTER**] and use [**▲**][**▼**] to select "**HDMI 1**" (default) or "**HDMI 2**".

Note

- You can make settings only when "**Video Output**" in "**Video Output**" is set to "**HDMI 1 / HDMI 2**" (Page 150).

"**Display Rec Status icon**": Use [**◀**][**▶**] to select whether to display the icon that indicates the unit is recording in the icon display area.

- "**ON**" (default): Displays the icon.
 - "**OFF**": Does not display the icon.
3. Press [**G**].
 - The dialogue box to confirm saving the settings is displayed.

Note

- If you proceed to step 2 in "To start and stop recording" without performing step 3, you can start recording with the changed settings. The changed settings are not saved, and when you stop recording, the settings return to the state before the changes.

4. Use [**◀**][**▶**] to select "**Yes**" and press [**ENTER**].
 - The system settings screen is displayed.

To start and stop recording

1. Select "**USB Rec Settings**" and press [**ENTER**].
 - The recording settings screen is displayed.
2. Use [**▲**][**▼**] to select "**USB Rec**" and press [**ENTER**].

When not recording: The dialogue box to confirm whether to start recording is displayed. Use [**◀**]

- [**▶**] to select "**Yes**" or "**No**" and press [**ENTER**]
- Selecting "**Yes**" starts recording.
 - Selecting "**No**" does not start recording.

When recording: The dialogue box to confirm whether to stop recording is displayed. Use [**◀**]

- [**▶**] to select "**Yes**" or "**No**" and press [**ENTER**]
- Selecting "**Yes**" stops recording.
 - Selecting "**No**" does not stop recording.

Note

- When you stop recording, do not remove the USB memory device until the recording complete dialogue box is displayed.

Using Multicast

Refer to "Using Multicast (Page 172)".

Setting the USB Device Mode

You can switch to USB host mode and USB Device Mode.

USB Host Mode: Connect a USB memory device to the USB jack to import or export data, update software, or perform USB recording.

USB Device Mode: Connect a computer to the USB jack to use this unit's camera and microphone with the computer.

Note

- You can make settings when "PC Peripheral" is enabled in "Enhancement".
- When using USB Device Mode, make sure to use the proprietary USB conversion cable.
- You cannot communicate with other sites in USB Device Mode (while "USB Device Mode" is set to "ON" in step 2).
- For details about USB Device Mode, refer to "Using USB Device Mode (Page 186)".

1. Select "USB Device Mode" and press [ENTER].
 - The USB Device Mode settings screen is displayed.
2. Use [▲][▼] to select the following items for input.
 - "USB Device Mode": Use [◀][▶] to select "ON" or "OFF" (default).
 - "Video Quality": When the unit's video frequency is 50 Hz
Press [ENTER] and use [▲][▼] to select "640x480 (Max. 25 fps)" (default) or "1280x720 (Max. 12.5 fps)".
When the unit's video frequency is 60 Hz
Press [ENTER] and use [▲][▼] to select "640x480 (Max. 30 fps)" (default) or "1280x720 (Max. 15 fps)".
 - "Display USB Device Mode icon": Use [◀][▶] to select whether to display the icon that indicates the unit is in USB Device Mode in the icon display area.
 - "ON" (default): Displays the icon.
 - "OFF": Does not display the icon.
3. Press [G].
If "USB Device Mode" was changed from "OFF" to "ON"

- The dialogue box to confirm saving the settings and switching the mode is displayed. When you use [◀][▶] to select "Yes" and press [ENTER], the USB Device Mode switches and the Home screen is displayed.

Note

- To display the computer screen on a TV connected to the unit, press [PC].
- The audio input during USB Device Mode is the same as when "HDMI Audio input / content" (Page 152) is set to "PC".

For all other cases

- The dialogue box to confirm saving the settings is displayed. When you use [◀][▶] to select "Yes" and press [ENTER], the system settings screen is displayed.

Note

- When you set "Display USB Device Mode icon" to "ON",  is displayed at the ① position during USB Device Mode.



Display Unit Information

You can view the setting information for the unit.

1. Select "System Info." and press [ENTER].
 - The unit information screen is displayed (Page 104).

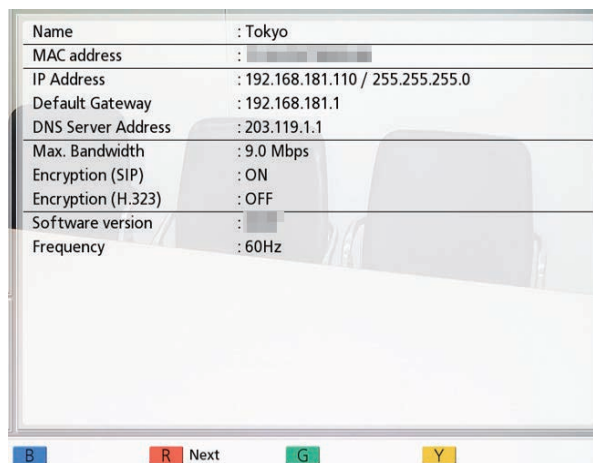

2. Press [BACK].
 - The system setting screen is displayed.

Checking Enhanced Features

You can check which features have been activated due to software enhancement (Page 158).

1. Select **"Enhancement"** and press **[ENTER]**.
 - The enhanced feature confirmation screen is displayed.

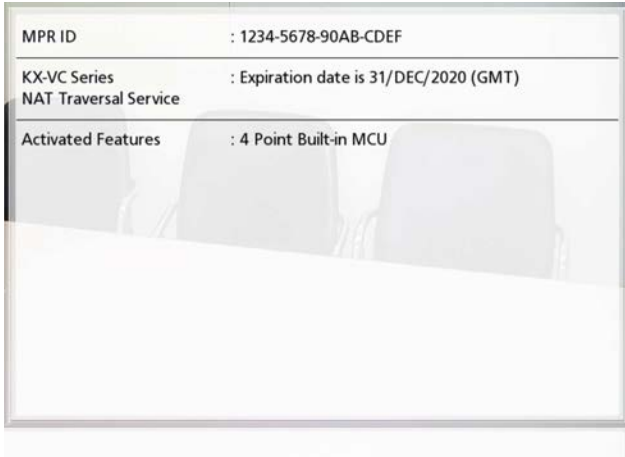

Note

- For details about **"Activated Features"**, refer to Page 158.

2. Press **[BACK]**.
 - The system setting screen is displayed.

Performing a Network Test

You can confirm whether a network connection can be established with a particular IP address.

Note

- You cannot perform a network test from the contact list screen or the call history screen.

1. Select **"Network Test"** and press **[ENTER]**.
 - The network test screen is displayed.

2. Enter an IP address.

Note

- If an IPv4 address contains 1 or 2 digit numbers, enter these numbers as they are. Do not enter like [.001].
Example: The IP address is [192.168.0.1].
 - Correct entry: [192.168.0.1]
 - Wrong entry: [192.168.000.001]
- For the input format when an IPv6 address is used, refer to Page 47.
- Host names cannot be entered.

3. Press **[R]**.
 - The network test starts. After the network test is finished, if the network test was successful or timed out, the details of the results are displayed. If the network test failed, a message indicating the failure is displayed.
4. Press **[BACK]**.
 - The system setting screen is displayed.

Performing Self Diagnosis

You can check how your image will be displayed and how your voice will be heard to the other party before starting a video conference call, using your own display and speakers.

Note

- Self diagnosis can be performed even when a headset is connected.

1. Select **"Self Diag."** and press **[ENTER]**.
 - The self diagnosis screen is displayed with the dialogue box.

Note

- You can hide or display the dialogue box by pressing **[B]**.
- Set the microphone at least 1 m (3.3 ft) away from the speakers.

2. Press **[R]**.
 - The self diagnosis starts.

Note

- Check the image that is displayed from the main video camera.
- To avoid feedback, slowly raise the volume using the remote control's **[+]** button.
- When someone speaks into the microphone, confirm whether the sound plays back through the speakers.
- During self diagnosis, all Boundary Microphones will be set to **"Center stereo"**.
- During self diagnosis, the tone will be set to **"Standard"**.

3. Press **[R]**.
 - The self diagnosis ends.

Note

- If you do not press **[R]**, the self diagnosis will automatically end after about 10 minutes.

4. Press **[BACK]**.
 - The system setting screen is displayed.

Displaying the Licence Information

You can display information about the licence and Open Source Software.

1. Select **"License Info."** and press **[ENTER]**.
 - The licence information display screen is displayed.
 - Press **[R]** to move to the next page, and press **[B]** to move to the previous page.
2. Press **[BACK]**.
 - The system setting screen is displayed.

Displaying the End-User Licence Agreement

You can display information about the End-User Licence Agreement.

1. Select **"EULA"** and press **[ENTER]**.
 - The End-User Licence Agreement display screen is displayed.
2. Press **[BACK]**.
 - The system setting screen is displayed.

Performing Remote Maintenance

The following operation is for performing remote maintenance by your dealer. After performing the operation, you cannot use the unit until remote maintenance is finished. However, turning the power off and then back on cancels remote maintenance, and you can use the unit. For details, contact your dealer.

1. Select **"Remote access"** and press **[ENTER]**.
 - The dialogue box confirming whether you want to start remote maintenance is displayed.

2. Use **[◀][▶]** to select **"Yes"** and press **[ENTER]**.
 - The remote maintenance screen is displayed.

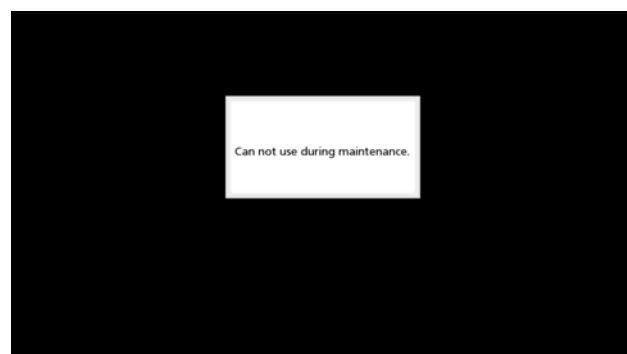

Making Administrator Menu Settings

Administrator Menu List

You can set, change, and confirm the unit's administrator functions.

Note

- If a video conference call is received while data is being entered, a dialogue box to confirm if you answer a video conference call is displayed.
Use [◀][▶] to select "Yes" or "No" and press [ENTER].
 - When "Yes" is selected, you can answer a video conference call while any unsaved data is lost.
 - When "No" is selected, you can continue entering the data.

1. Press [MENU].
 - The Menu screen is displayed.
2. Use [▲][▼] to select "Settings" and press [ENTER].
 - The system settings screen is displayed.

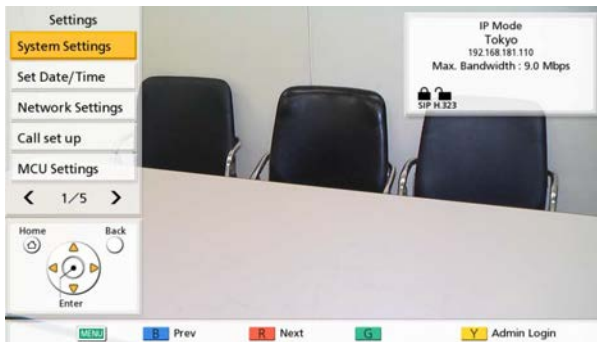

3. Press [◀][▶] to display the fourth page.
4. Use [▲][▼] to select "Admin login" and press [ENTER].
 - The login screen is displayed.

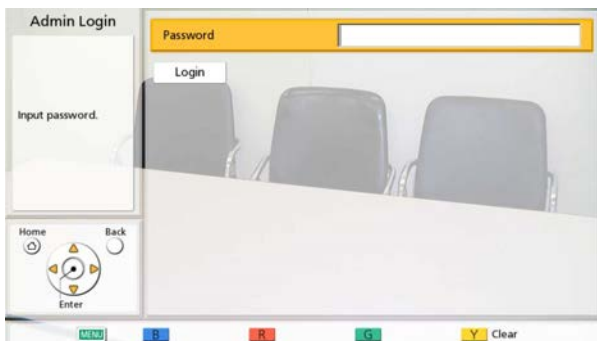

5. Use [▲][▼] to select "Password", then enter the administrator password (4–10 digits).
 - The administrator menu screen is displayed.

Note

- You can display the login screen by pressing [Y] in the Menu screen instead of performing steps 1–4.
- Please enter the administrator password that was set during installation.
- If you forget the administrator password, please contact your dealer.

6. Use [▲][▼] to select "Login" and press [ENTER].
 - The Administrator menu list is displayed.

Administrator Menu Screen List

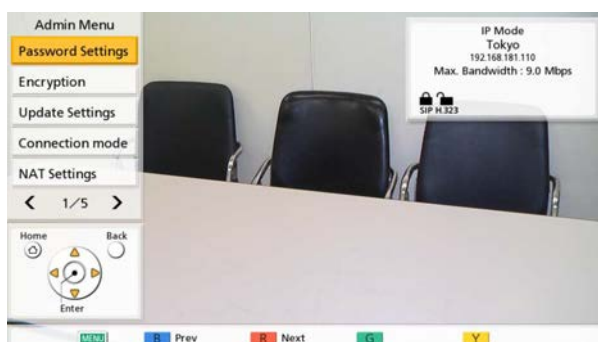

- 1 Password Settings:
Sets the unit's administrator password (Page 140).
- 2 Encryption:
Sets the use of encrypted communications and users, etc. (Page 140).
- 3 Update Settings:
Performs the settings for confirming the latest version before performing a software update (Page 141).
- 4 Connection mode:
Sets the mode for communicating with the other party (Page 142).
- 5 NAT Settings:
Sets NAT information (Page 142).

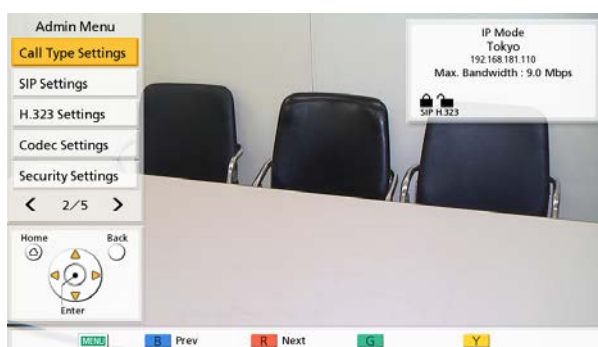
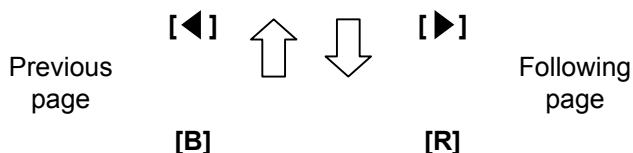

- 6 Call Type Settings:
Sets the communication types used by the unit (Page 143).
- 7 SIP Settings:
Sets SIP settings (Page 144).
- 8 H.323 Settings:
Sets H.323 settings (Page 145).
- 9 Codec Settings:
Sets the enabling/disabling of codecs (Page 147).
- 10 Security Settings:
Sets settings such as call denied and call history (page 147).

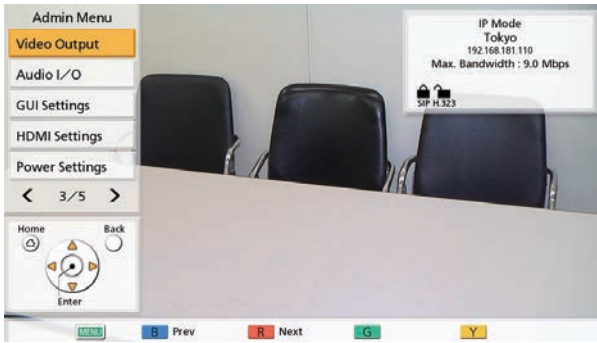
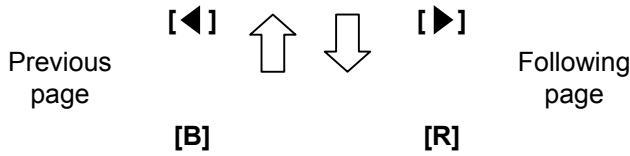

- 11 Video Output:
Sets HDMI and analogue component video output (Page 150).
- 12 Audio I/O:
Sets audio settings (Page 152).
- 13 GUI Settings:
Sets which items are displayed on the menu screens and other screens (Page 153).
- 14 HDMI Settings:
Sets the enabling/disabling of control via HDMI (Page 154).
- 15 Power Settings:
Sets automatic power on and off (Page 154).

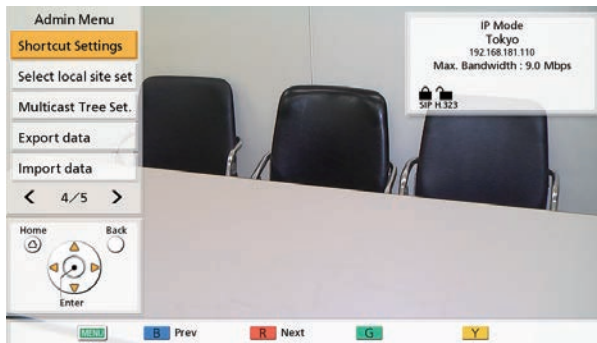
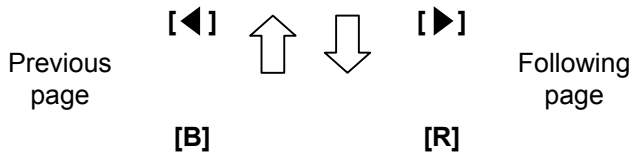

- 16 Shortcut Settings:
Sets the shortcut function where the remote control's colour keys can be set to display screens such as the network settings screen (Page 155).
- 17 Select local site set:
Sets local site settings (Page 156).
- 18 Multicast Tree Set.:
Sets the multicast function settings (Page 175).
- 19 Export data:
Exports information from the contact list, etc. (Page 156).
- 20 Import data:
Imports exported data from a USB memory device (Page 157).

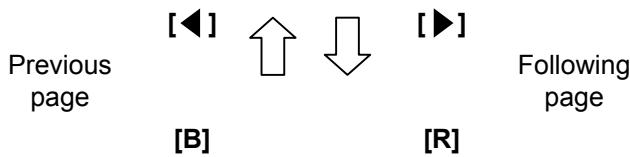

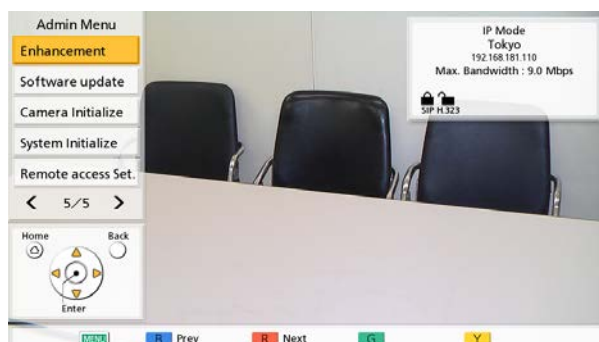

- ① Enhancement:
Activates registration keys used for enhancing the features of the device (Page 158).
- ② Software update:
Updates the software from a USB memory device (Page 159).
- ③ Camera Initialize:
Initialises your own site's video camera (Page 160).
- ④ System Initialize:
Initialises all settings apart from those for functions enabled from enhanced software (Page 160).
- ⑤ Remote access Set.:
Sets the settings required to remotely access the unit (Page 161).

7. Use [**▲**][**▼**] to select the items for input and press [**ENTER**].
 - The selected screen is displayed. Perform settings following the descriptions of each screen (① through ⑤).
8. Press [**Home**].
 - The Home screen is displayed.

Making Administrator Password Settings

1. Select **"Password Settings"** and press **[ENTER]**.
 - The password settings screen is displayed.
2. Use **[▲][▼]** to select the following items and enter a password (4–10 digits):
 - "Current password"**: Enter the current password (default: 00000000).
 - "New password"**: Enter the new password.
 - "Retype new password"**: Enter the new password again.

Note

 - Please change the default login password the first time the unit is installed.
 - Be sure to keep the password safe.
3. Press **[G]**.
 - A dialogue box to confirm the changing of settings is displayed.
4. Use **[◀][▶]** to select **"Yes"** and press **[ENTER]**.
 - The administrator menu screen is displayed.

Making Encryption Settings

Note

- For 2-party video conference calls, a connection cannot be made if the two party's settings for communication encryption do not match. However, when communication is performed using H.323, and either site has **"Best effort"** set for **"Encryption (H.323)"**, a connection can be made even if the sites' communication encryption settings are not the same. For multiple-party video conference calls, the ability for the Main Site to connect to Sub Sites is determined the same way as for 2-party video conference calls.
- Be careful when changing encryption settings because doing so may cause you to become unable to communicate with other parties.
- There is a danger that encryption settings will be changed by a third party. Therefore, be careful when managing the administrator password and giving users the authority to change encryption settings.

- If an encryption key is not set for SIP communication, you cannot enable encryption.
 - When using encrypted communication with the KX-VC Series NAT Traversal Service, set SIP communication encryption using this setting. When using IP/NAT traversal mode, use the same encryption settings as for SIP communication in IP mode or NAT traversal mode.
 - Be aware that if encryption is disabled, eavesdropping might be possible on networks that are not secured against such actions.
1. Select **"Encryption"** and press **[ENTER]**.
 - The encryption settings screen is displayed.

2. Use **[▲][▼]** to select the following items for input:

Note

- When using IP mode:
 - When **"SIP"** is set to **"OFF"** on the call type settings screen (Page 143), **"Access mode (SIP)"**, **"Encryption (SIP)"** and **"Encryption Key (SIP)"** cannot be set.
 - When **"H.323"** is set to **"OFF"** on the call type settings screen (Page 143), **"Access mode (H.323)"** and **"Encryption (H.323)"** cannot be set.
 - **"Access mode (NAT Traversal)"** and **"Encryption (NAT Traversal)"** cannot be set.
- When using NAT Traversal mode:
 - **"Access mode (SIP)"**, **"Encryption (SIP)"**, **"Access mode (H.323)"**, and **"Encryption (H.323)"** cannot be set.
- When using IP/NAT Traversal mode:
 - When **"H.323"** is set to **"OFF"** on the call type settings screen (Page 143), **"Access mode (H.323)"** and **"Encryption (H.323)"** cannot be set.

"Access mode (SIP)"/"Access mode (NAT Traversal)"/"Access mode (H.323)": Use **[◀][▶]** to select **"Admin"** (default) or **"User"**.

- When **"Admin"** is selected, only the network administrator can enable/disable encryption.
- When **"User"** is selected, any users can enable/disable encryption (Page 123, Page 123, Page 123).

"Encryption (SIP)"/"Encryption (NAT Traversal)": Use **[◀][▶]** to select whether to enable encryption.

- **"ON"**: Encryption is enabled.

- **"OFF"** (default): Encryption is disabled.
- "Encryption Key (SIP)"**: Enter an encryption key (4 to 256 characters [alphanumeric, space, symbols]) (Page 190).

Note

- &, <, >, comma (,), double quotation mark (") cannot be entered.
- While being entered, the characters of the encryption key are displayed, but once the settings are saved, all the characters will be displayed as asterisks (*), and you will no longer be able to check the encryption key on the screen. Record the encryption key beforehand, and store it in a safe location.
- If the value specified in **"Encryption Key (SIP)"** does not match the other party's, the video conference call will not start even if encryption is enabled.
- When the encryption key is displayed as asterisks (*), pressing **[Y]** deletes the entire encryption key.
- The name of **"Encryption Key (SIP)"** changes depending on the connection mode.
 - When IP mode is used: **"Encryption Key (SIP)"**
 - When using NAT Traversal mode: **"Encryption Key (NAT Traversal)"**
 - When using IP/NAT Traversal mode: **"Encryption Key (SIP / NAT Trav.)"**

"Encryption (H.323)": Press **[ENTER]** and use **[▲][▼]** to select whether to enable encryption.

- **"Best effort"**: enables encrypted communication when the other party has enabled encrypted communication. When disabled, communication is performed without encryption.
- **"ON"**: Encryption is enabled.
- **"OFF"** (default): Encryption is disabled.

Note

- This setting is available only when **"Admin"** is selected for **"Access mode (SIP)"/"Access mode (H.323)"**.

3. Press **[G]**.
 - A dialogue box to confirm the saving of settings is displayed.
4. Use **[◀][▶]** to select **"Yes"** and press **[ENTER]**.
 - The administrator menu screen is displayed.

Making Software Update Settings

Preparation settings for updating the software can be made here.

Note

- The DNS server setting is necessary to check for upgrades and to download the latest software from the network (Page 118).

1. Select **"Update Settings"** and press **[ENTER]**.
 - The update settings screen is displayed.
2. Use **[▲][▼]** to select the following items for input: **"Proxy Server Address"**: Enter the IP address of the proxy server.

Note

- IPv6 addresses and host names cannot be used for setting.
- If the IP address contains 1 or 2 digit numbers, enter these numbers as they are. Do not enter like [.001].
 - Example: The IP address is [192.168.0.1].
 - Correct entry: [192.168.0.1]
 - Wrong entry: [192.168.000.001]

"Proxy Server Port": Enter the proxy server port number (1–65535).

"Automatic Version Check": Use **[◀][▶]** to select **"ON"** or **"OFF"** (default).

- When **"ON"** is selected, the unit will automatically look up the DNS server or proxy server to see if there are updates for your software on start-up. If updates are available, a dialogue box is displayed on the Home screen.
- When **"OFF"** is selected, the unit will not automatically look up the DNS server or proxy server to see if there are updates for your software on start-up.

3. Press **[G]**.
 - A dialogue box to confirm the saving of settings is displayed.
4. Use **[◀][▶]** to select **"Yes"** and press **[ENTER]**.
 - The administrator menu screen is displayed.

Making Connection Mode Settings

1. Select **"Connection mode"** and press **[ENTER]**.
 - The connection mode setting screen is displayed.
2. Press **[ENTER]**, use **[▲][▼]** to select the desired connection mode, and then press **[ENTER]** again.

"IP Mode": Communication is established over the Internet or an intranet.

"NAT Traversal Mode": Communication is established using KX-VC Series NAT Traversal Service.

"IP / NAT Traversal Mode": Performs communication using the 2 modes of IP Mode and NAT Traversal Mode.

Note

 - Communication cannot be established with a party whose connection mode setting differs from yours.
 - **"NAT Traversal Mode"** can be used only after activating KX-VC Series NAT Traversal Service with an activation key. For details about KX-VC Series NAT Traversal Service, refer to the following web site:
https://panasonic.net/cns/psn/products/hdvc/nat/nat_traversal/index.html
3. Press **[G]**.
 - A dialogue box to confirm the saving of settings and system restart after saving is displayed.
4. Use **[◀][▶]** to select **"Yes"** and press **[ENTER]**.
 - The system will automatically restart to reflect changes to system settings.

Note

- When changing the connection mode, the time required for a restart may depend on network conditions.

Making NAT Settings

Note

- To change the static NAT settings, it is necessary to configure system settings, including the port number settings. For details, contact your dealer.

- When using IP mode (Page 142), **"NAT"** is not displayed in step 2.
- When using NAT traversal mode (Page 142), **"Static NAT"**, **"WAN IP Address"**, and **"Local address judgement"** are not displayed in step 2.
- This setting is available only when **"IP Address (LAN 1)"** (setting) is set to **"Manual"** in **"Network Settings"** (Page 118).
- Depending on the model you are using, the available settings for **"RTP and RTCP for Audio"**, **"RTP and RTCP for Video"**, **"Camera Control"**, **"RTP and RTCP for Video (Sub)"**, **"BFCP"**, and **"H.245"** differ. The available settings are written in the order of KX-VC2000, KX-VC1600, and then KX-VC1300/ KX-VC1000.

1. Select **"NAT Settings"** and press **[ENTER]**.
 - The NAT settings screen is displayed.
2. Use **[▲][▼]** to select the following items for input:
 - The following items are displayed over 2 pages. To view all the items, press **[R]** to move to the next page, and press **[B]** to move to the previous page.
 - If the settings have been changed, press **[G]** before changing to a different screen to save the settings.

"NAT": Press **[ENTER]** and use **[▲][▼]** to select **"Dynamic"** (default) or **"Static"**.

"Static NAT": Use **[◀][▶]** to select **"ON"** or **"OFF"** (default).

Note

- To select **"ON"**, **"H.460"** must be set to **"OFF"** on the H.323 settings screen (Page 145).
- When **"ON"** is selected, the IP address of the WAN side will be displayed for the unit information on the Home screen (Page 41).

"WAN IP Address": Enter the WAN IP address of the router.

Note

- IPv6 addresses cannot be used for setting.
- If the IP address contains 1 or 2 digit numbers, enter these numbers as they are. Do not enter like [.001].
 Example: The IP address is [192.168.0.1].
 - Correct entry: [192.168.0.1]
 - Wrong entry: [192.168.000.001]

- If **"Obtain automatically"** is displayed, the WAN IP address cannot be set. For details, contact your dealer.

"Local address judgement": Press [ENTER] and use [▲][▼] to select **"OFF"** (default) or **"Auto"**.

- **"OFF"** (default): Static NAT is applied to all addresses.
- **"Auto"**: Static NAT is not applied to private addresses.

"Conversion IP and Port Num.": Use [◀][▶] to select **"ON"** or **"OFF"** (default).

Note

- When using a router that features Symmetric NAT to connect to a mobile device, select **"ON"**.
- When **"ON"** is selected, configure static NAT settings for the unit and the router that the unit is connected to.

"RTP and RTCP for Audio": Enter the initial port number (**5100–5108/5100–5164/5100–5188**) for RTP and RTCP for Audio (default: **5100**).

"RTP and RTCP for Video": Enter the initial port number (**5200–5208/5200–5264/5200–5288**) for RTP and RTCP for Video (default: **5200**).

"Camera Control": Enter the initial port number (**5300–5308/5300–5364/5300–5388**) for controlling a video camera (default: **5300**).

"RTP and RTCP for Video (Sub)": Input the sub image RTP/RTCP port number (**5400–5408/5400–5464/5400–5488**). (default: **5400**)

"BFCP": Input the BFCP initial port number (**5800–5876/5800–5890/5800–5895**). (default: **5800**)

"SIP": Enter the port number for 2-party video conference calls (**5000–5099**) for communication using a SIP server (default: **5060**).

Note

- The changed port number will be displayed on the unit information screen (Page 104).

"H.245": Enter the initial port number for H.245 (**5500–5550/5500–5580/5500–5590**) (default: **5500**).

Note

- For the following items, a number will be automatically added to the initial port number that you enter. The total number indicates the range and values of available port numbers for the items.
 - **"RTP and RTCP for Audio"**
 - **"RTP and RTCP for Video"**
 - **"Camera Control"**

- **"RTP and RTCP for Video (Sub)"**
- **"BFCP"**
- **"H.245"**

3. Press [G].

- A dialogue box to confirm the saving of settings is displayed.

4. Use [◀][▶] to select **"Yes"** and press [ENTER].

- The administrator menu screen is displayed.

Making Call Type Settings

1. Select **"Call Type Settings"** and press [ENTER].

- The call type settings screen is displayed.

2. Use [▲][▼] to select the following items for input:

"SIP": Use [◀][▶] to select **"ON"** (default) or **"OFF"**.

Note

- When **"OFF"** is selected, you cannot use a SIP server even if **"ON"** is set to **"SIP Server"** (Page 144).
- If the other party is using the KX-VC300/ KX-VC600 with a software version older than 3.00 (not including 3.00), you cannot make a video conference call using H.323. You must select **"ON"**.

"H.323": Use [◀][▶] to select **"ON"** (default) or **"OFF"**.

Note

- When **"OFF"** is selected, you cannot use a gatekeeper and H.460 even if **"ON"** is selected for **"Gatekeeper"** and **"H.460"** (Page 145).

"Priority for connection mode": Press [ENTER] and use [▲][▼] to select **"IP Mode (SIP)"** (default), **"IP Mode (H.323)"**, or **"NAT Traversal Mode"**.

Note

- The communication type selected here will be reflected onto the device's settings such as its displayed contents and default connection mode values for making calls.

3. Press [G].

- A dialogue box to confirm the saving of settings is displayed.

4. Use [◀][▶] to select "Yes" and press [ENTER].
 - The administrator menu screen is displayed.

Making SIP Settings

When using a SIP server over an intranet, video conference calls can be made using SIP URIs (SIP user name@SIP domain name).

Note

- These settings can only be made when "SIP" is set to "ON" on the call type settings screen.
 - Video conference calls to an MCU or a non-Panasonic video conference system through a SIP server using a SIP URI are not guaranteed.
 - When connecting to an MCU by entering the MCU's conference room number@IP address, "SIP Server" and "Gatekeeper" (Page 145) must be set to "OFF".
 - If video conference calls cannot be made because there is a problem with the SIP server, the SIP settings are incorrect (on the server, or on the unit), etc., "Not registered" will be displayed on the Home screen instead of the SIP user name. In this case, you cannot make calls using either IP addresses or SIP. Contact your network administrator.
1. Select "SIP Settings" and press [ENTER].
 - The SIP setting screen is displayed.
 2. Use [▲][▼] to select the following items for input:

"SIP Server": Use [◀][▶] to select "ON" or "OFF" (default).

Note

- To communicate using a SIP server, "ON" must be selected and "SIP Server Address", "SIP Username", and "SIP Domain Name" must be set.
- To select "ON", "Gatekeeper" (Page 145) must be set to "OFF".

"SIP Server Address": Enter the SIP server's IP address (or host name).

Note

- If an IPv4 address contains 1 or 2 digit numbers, enter these numbers as they are. Do not enter like [.001]. Example: The IP address is [192.168.0.1].
 - Correct entry: [192.168.0.1]

- Wrong entry: [192.168.000.001]
- For the input format when an IPv6 address is used, refer to Page 47.
- The DNS server setting is necessary to enter host names (Page 118).
- See Page 47 for details about the characters that can be input for host names.

"SIP Username": Enter the SIP user name.

"SIP Domain Name": Enter the SIP domain name.

Note

- See Page 47 for details about the characters that can be input.
- Enter a standards-compliant value. For details, contact your network administrator.

"Digest Authentication": Use [◀][▶] to select whether to enable digest authentication.

- "ON": Enables digest authentication.
- "OFF" (default): Disables digest authentication.

"Authentication ID": Enter an authentication ID (1–60 characters [alphanumeric, space, symbols]) (Page 190). &, <, >, comma (,), double quotation mark (") cannot be entered.

"Authentication Password": Enter an authentication password (0–60 characters [alphanumeric, space, symbols]) (Page 190). &, <, >, comma (,), double quotation mark (") cannot be entered.

Note

- To communicate using a SIP server, it may be necessary to set "Digest Authentication", "Authentication ID", and "Authentication Password". For details, contact your network administrator.
- "Authentication ID" and "Authentication Password" can only be set when "Digest Authentication" is set to "ON".
- While being entered, the characters of the authentication password are displayed, but once the settings are saved, all the characters will be displayed as asterisks (*), and you will no longer be able to check the authentication password on the screen. Record the authentication password beforehand, and store it in a safe location.
- When the authentication password is displayed as asterisks (*), pressing [Y] deletes the entire authentication password.

"SIP Transport Protocol": Press [ENTER] and then use [▲][▼] to select between protocols (UDP, TCP, Auto (Switch by Site), or Auto (TCP / UDP) [default]) used when communicating via SIP.

Note

- When **Auto (Switch by Site)** is selected, TCP will be used if using a SIP server, and UDP will be used if not using a SIP server. When **Auto (TCP / UDP)** is selected, communication will be attempted in order of TCP and then UDP. Normally, select **Auto (TCP / UDP)**.

3. Press **[G]**.

- A dialogue box to confirm the saving of settings is displayed.

4. Use **[◀][▶]** to select **"Yes"** and press **[ENTER]**.

- The administrator menu screen is displayed.

Making H.323 Settings

Note

- These settings can only be made when **"H.323"** is set to **"ON"** on the call type settings screen.
- When connecting to an MCU by entering the MCU's conference room number@IP address, **"SIP Server"** (Page 144) and **"Gatekeeper"** must be set to **"OFF"**.
- If video conference calls cannot be made because there is a problem with the gatekeeper and H.460 server, the H.323 settings are incorrect (on the gatekeeper and the H.460 server, or on the unit), etc., **"Not registered"** will be displayed on the Home screen instead of the H.323 extension/H.323 name. In this case, you cannot make calls using either IP addresses or the gatekeeper and H.460 server. Contact your network administrator.

1. Select **"H.323 Settings"** and press **[ENTER]**.

- The H.323 settings screen is displayed.

2. Use **[▲][▼]** to select the following items for input:

"Gatekeeper": Use **[◀][▶]** to select **"ON"** or **"OFF"** (default).

Note

- This setting is available only when **"ON"** is selected for **"H.323"** (Page 143) and **"OFF"** is selected for **"SIP Server"**.

"Gatekeeper Address": Enter the gatekeeper's IP address (or host name).

Note

- If an IPv4 address contains 1 or 2 digit numbers, enter these numbers as they are. Do not enter like [.001]. Example: The IP address is [192.168.0.1].
 - Correct entry: [192.168.0.1]
 - Wrong entry: [192.168.000.001]
- For the input format when an IPv6 address is used, refer to Page 47.
- The DNS server setting is necessary to enter host names (Page 118).
- See Page 47 for details about the characters that can be input for host names.

"H.323 Name": Enter the H.323 name.

"H.323 Extension": Enter the H.323 extension.

Note

- See Page 47 for details about the characters that can be input.
- Enter a standards-compliant value. For details, contact your network administrator.

"Authentication": Use **[◀][▶]** to select whether to enable authentication.

- **"ON"**: Enables authentication.
- **"OFF"** (default): Disables authentication.

"Authentication ID": Enter an authentication ID (1–60 characters [alphanumeric, space, symbols]) (Page 190). **&**, **<**, **>**, comma (**,**), double quotation mark (**"**) cannot be entered.

"Authentication Password": Enter an authentication password (0–60 characters [alphanumeric, space, symbols]) (Page 190). **&**, **<**, **>**, comma (**,**), double quotation mark (**"**) cannot be entered.

Note

- **"Authentication ID"** and **"Authentication Password"** can only be set when **"Authentication"** is set to **"ON"**.
- While being entered, the characters of the authentication password are displayed, but once the settings are saved, all the characters will be displayed as asterisks (*****), and you will no longer be able to check the authentication password on the screen. Record the authentication password beforehand, and store it in a safe location.
- When the authentication password is displayed as asterisks (*****), pressing **[Y]** deletes the entire authentication password.

"H.460": Use **[◀][▶]** to select **"ON"** or **"OFF"** (default).

3. Press **[G]**.
 - A dialogue box to confirm the saving of settings is displayed.
4. Use **[◀][▶]** to select **"Yes"** and press **[ENTER]**.
 - The administrator menu screen is displayed.

Making Codec Settings

These settings determine which codecs are enabled and disabled.

Note

- Changing codec settings may affect the ability to make and receive calls. For details, contact your dealer.
- If **"NAT Traversal Mode"** is selected in the connection mode settings, codec settings will not be displayed.

1. Select **"Codec Settings"** and press [ENTER].

- The codec settings screen is displayed.

2. Select the following items for input.

- The following items are displayed over 2 pages. Press [B] to move to the H.323 setting screen. To return to the SIP setting screen, press [B] again.

"SIP / Video System"/"SIP / Audio System"/"H.323 / Video System"/"H.323 / Audio System": Use [▲][▼] to select the item that you want to change and press [ENTER].

- Checkmarks are added or removed. Codecs without a checkmark are disabled.
- By default, all are enabled.

Note

- The setting of **"H.264 / Baseline Profile (PktMode0)"** codec for **"H.323 / Video System"** and the setting of **"G.722"** codec for **"H.323 / Audio System"** cannot be changed.
- The setting of **"H.264 / Baseline Profile (PktMode0)"** codec for **"SIP / Video System"** and the setting of **"G.722"** codec for **"SIP / Audio System"** cannot be changed.

"SIP / QoS"/"H.323 / QoS": Press [ENTER] and use [▲][▼] to select whether to enable QoS.

- **"ON"** (default): QoS will be enabled.
- **"OFF"**: QoS will be disabled.

3. Press [G].

- A dialogue box to confirm the saving of settings is displayed.

4. Use [◀][▶] to select **"Yes"** and press [ENTER].

- The administrator menu screen is displayed.

Making Security Settings

Settings such as call denied, call history, and USB recording can be made here.

1. Select **"Security Settings"** and press [ENTER].

- The security settings screen is displayed.

2. Select the following items for input using [▲][▼].

Note

- The items are displayed across 2 screens. You can display all items by pressing [R] to move to the next screen and pressing [B] to move to the previous screen. If you changed the settings, press [G] before moving screens to save the settings.

"Incoming Call from a non-regist.": Use [◀][▶] to select whether to allow incoming calls from units not registered in the contact list.

- **"ON"** (default): Allows incoming calls.

- **"OFF"**: Rejects incoming calls.

Note

- When **"Incoming Call from a non-regist."** is set to **"ON"**, **"HDVC Incoming Call"**, **"HDVC Mobile Incoming Call"**, and **"Save denied call to History"** are not available.

"HDVC Incoming Call": When **"Incoming Call from a non-regist."** is set to **"OFF"**, use [◀][▶] to select whether to allow incoming calls from HD Visual Communication Unit/HDVC-MPCS.

- **"ON"**: Allows incoming calls.
- **"OFF"** (default): Rejects incoming calls.

"HDVC Mobile Incoming Call": When **"Incoming Call from a non-regist."** is set to **"OFF"**, use [◀][▶] to select whether to allow incoming calls from HDVC Mobile (Page 171).

- **"ON"**: Allows incoming calls.
- **"OFF"** (default): Rejects incoming calls.

"Incoming Call Authentication": Use [◀][▶] to select whether to authenticate incoming calls with an authentication number.

- **"ON"**: Performs authentication.
- **"OFF"** (default): Does not perform authentication.

Note

- When **"Incoming Call Authentication"** is set to **"OFF"**, you cannot set **"Authentication Number"**, **"HDVC Authentication"**, and **"HDVC Mobile Authentication"**.
- You cannot use authentication features for incoming calls from communication through a SIP server or H.323 gatekeeper.
- When **"Incoming Call from a non-regist."** is set to **"OFF"** and **"Incoming Call Authentication"** is set to **"ON"**, you will receive incoming calls if either one of the conditions for allowing incoming calls is met.

"Authentication Number": If **"Incoming Call Authentication"** is set to **"ON"**, set a 6 to 20 digit number.

Note

- A terminal making a call must input the same number as **"Authentication Number"** with the conference room number.
Outgoing call number example) When the authentication number is "123456"
(Correct) 123456@192.168.0.1
(Wrong) 12345678@192.168.0.1
If the terminal making a call is another company's terminal, a different string may be used instead of "@" (example: 123456##192.168.0.1).
The authentication number is recognized as "123456" even in this case.

"HDVC Authentication": If **"Incoming Call Authentication"** is set to **"ON"**, use [◀][▶] to select whether to authenticate incoming calls from HD Visual Communication Units/HDVC-MPCS.

- **"ON"** (default): Performs authentication.
- **"OFF"**: Allows incoming calls without authentication.

"HDVC Mobile Authentication": If **"Incoming Call Authentication"** is set to **"ON"**, use [◀][▶] to select whether to authenticate incoming calls from HDVC Mobile.

- **"ON"** (default): Performs authentication.
- **"OFF"**: Allows incoming calls without authentication.

"Save denied call to History": When **"Incoming Call from a non-regist."** is set to **"OFF"** or **"Incoming Call Authentication"** is set to **"ON"**, use [◀][▶] to select whether to save rejected calls to the call history.

- **"ON"** (default): Saves calls.
- **"OFF"**: Does not save calls.

Note

- If **"Incoming Call from a non-regist."** is set to **"ON"** and **"Incoming Call Authentication"** is set to **"OFF"**, you cannot set **"Save denied call to History"**.

"How to Save Call History": Press **[ENTER]**, and select the how to save calls to the call history using **[▲][▼]**.

- **"Latest Call History"**: Only the latest call to the same party is saved.
- **"Entire Call History"** (default): All calls are saved to the call history.

"Delete Call History": Use **[◀][▶]** to select whether to enable deletion of the call history entries in the call history screen.

- **"ON"** (default): Enables deletion.
- **"OFF"**: Disables deletion.

"USB Rec": Use **[◀][▶]** to select enabling or disabling USB recording features.

- **"ON"**: Enables recording features.
- **"OFF"** (default): Disables recording features.

3. Press **[G]**.

- The dialogue box to confirm saving the settings is displayed.

4. Use **[◀][▶]** to select **"Yes"** and press **[ENTER]**.

- The administrator menu screen is displayed.

Making Video Output Settings

Sets video output to HDMI.

1. Select **"Video Output"** and press **[ENTER]**.
 - The video output settings screen is displayed.
2. Use **[▲][▼]** to select the following items for input:
 - "Video Output"**: Press **[ENTER]** and use **[▲][▼]** to select whether to use HDMI2.
 - **"HDMI 1"** (default): Only HDMI1 is used.
 - **"HDMI 1 / HDMI 2"**: HDMI1 and HDMI2 are used for the display of 2 screens.

Note

- When **"HDMI 1 / HDMI 2"** is selected for the KX-VC1300 or KX-VC1600, or a KX-VC1000 that has been expanded for HDMI Dual Monitor, PinP is not available.
- When using a KX-VC1000 that has not been expanded for HDMI Dual Monitor support, **"Video Output"** is not displayed. In this case, the available selections for **"Default Screen Layout"**, **"Layout 1 (Switching video)"**, and **"Layout 2 (Switching video)"** are the same as when **"HDMI 1"** is selected for **"Video Output"**.

When selecting **"HDMI 1"**:

"Default Screen Layout": Press **[ENTER]** and use **[▲][▼]** to select the layout during video conference calls when contents are not being shared.

- **"Other Site"** (default): Displays the image of the other party's site.
- **"Other / Local (PwithP)"**: Displays the image of the other party's site with your own site's image as a picture-in-picture.
- **"Other / Local (SideBySide)"**: Displays the image of the other party's site with your own site's image arranged side-by-side.
- **"Local Site"**: Displays the image of your own site.

"Layout 1 (Switching video)": Press **[ENTER]** and use **[▲][▼]** to select the display method when contents are shared during single stream communication.

- **"Content"** (default): Displays your own site's shared contents.
- **"Content / Camera (PwithP)"**: Displays your own site's shared contents with camera image of the other party's site as a picture-in-picture.

- **"Content / Camera (SideBySide)"**: Displays your own site's shared contents with camera image of the other party's site arranged side-by-side.
- **"Other Site"**: Displays camera image of the other party's site.
- **"Local Site"**: Displays camera image of your own site.

"Layout 2 (Switching video)": Press **[ENTER]** and use **[▲][▼]** to select the display method when contents are shared during dual stream communication.

- **"Content"** (default): Displays your own shared contents.
- **"Content / Other (PwithP)"**: Displays your own site's shared contents with camera image of the other party's site as a picture-in-picture.
- **"Content / Local (PwithP)"**: Displays your own site's shared contents and camera image as a picture-in-picture.
- **"Content / Other (SideBySide)"**: Displays your own site's shared contents with camera image of the other party's site arranged side-by-side.
- **"Content / Local (SideBySide)"**: Displays your own site's shared contents and camera image arranged side-by-side.
- **"Other Site"**: Displays camera image of the other party's site.
- **"Local Site"**: Displays the image of your own site.

When selecting **"HDMI 1 / HDMI 2"**:

"Default Screen Layout": Press **[ENTER]** and use **[▲][▼]** to select the layout during video conference calls when contents are not being shared.

- **"Other / Local"** (default): Displays the image of the other party using HDMI1, and your own site's image using HDMI2.
- **"Local / Other"**: Displays your own site's image using HDMI1, and the image of the other party image using HDMI2.
- **"Other / Other"**: Displays the image of the other party image using HDMI1 and HDMI2.

"Layout 1 (Switching video)": Press **[ENTER]** and use **[▲][▼]** to select the display method when contents are shared during single stream communication.

- **"Content / Other"** (default): Displays your own shared contents using HDMI1, and the image of the other party using HDMI2.

- **"Other / Content"**: Displays the image of the other party using HDMI1, and your own site's shared contents using HDMI2.
- **"Content / Content"**: Displays the image of your own site's shared contents using HDMI1 and HDMI2.

"Layout 2 (Switching video)": Press **[ENTER]** and use **[▲][▼]** to select the display method when contents are shared during dual stream communication.

- **"Content / Other"** (default): Displays your own shared contents using HDMI1, and the image of the other party using HDMI2.
- **"Other / Content"**: Displays the image of the other party using HDMI1, and your own site's shared contents using HDMI2.
- **"Content / Content"**: Displays the image of your own site's shared contents using HDMI1 and HDMI2.

"Output of HDMI 3" (KX-VC1600/KX-VC2000): Press **[ENTER]** and use **[▲][▼]** to select the output to HDMI3.

- **"Local site video"** (default): Outputs your own site's image to HDMI3.
- **"Rec (HDMI 1 / LR-Split)"**: Split the signals of HDMI1 for video and audio recording, outputting L (other sites' audio) and R (your own site's audio) to HDMI3.
- **"Rec (HDMI 1 / LR-Mix)"**: Combine the signals of HDMI1 for video and audio recording, outputting L (other sites' audio) and R (your own site's audio) to HDMI3.
- **"Rec (HDMI 2 / LR-Split)"**: Split the signal of HDMI2 for video and audio recording, outputting L (other sites' audio) and R (your own site's audio) to HDMI3.
- **"Rec (HDMI 2 / LR-Mix)"**: Combine the signals of HDMI2 for video and audio recording, outputting L (other sites' audio) and R (your own site's audio) to HDMI3.

Note

- When your own site's image is selected, use the video camera at a resolution of 1080p/1080i. 720p cannot be used.

"Analog compo. video output" (KX-VC1600/KX-VC2000): Press **[ENTER]** and use **[▲][▼]** to select settings for analogue component output.

- **"Same as HDMI 1"** (default): Outputs an analogue component signal that is the same image as for HDMI1.

- **"Same as HDMI 2"**: Outputs an analogue component signal that is the same image as for HDMI2.

"Max. Resolution" (KX-VC1600/KX-VC2000): Press **[ENTER]** and use **[▲][▼]** to select **"1080i"** (default) or **"1080p"**.

Note

- The set maximum resolution that will be applied will be for analogue component output and an HDMI output equivalent to analogue component.

"Display position of local site": Press **[ENTER]** and use **[▲][▼]** to select the picture-in-picture (PinP) display position of your site's image.

- **"Upper right"** (default): Your image is displayed at the upper-right part of the screen.
- **"Lower right"**: Your image is displayed at the lower-right part of the screen.
- **"Upper left"**: Your image is displayed at the upper-left part of the screen.
- **"Lower left"**: Your image is displayed at the lower-left part of the screen.

Note

- For the KX-VC1300 or KX-VC1600, or a KX-VC1000 that has been expanded for HDMI Dual Monitor, when **"HDMI 1 / HDMI 2"** is selected in **"Video Output"**, PinP is not available.
- By pressing **[R]** during video conference calls, you can move your own image clockwise from the preset position (**"PinP"** is displayed for the **[R]** guideline). You can stop displaying your own image by pressing **[BACK]**.

3. Press **[G]**.
 - A dialogue box to confirm the changing of settings is displayed.
4. Use **[◀][▶]** to select **"Yes"** and press **[ENTER]**.
 - The administrator menu screen is displayed.

Making Audio Input/Output Settings

Note

- These settings are for adjusting the audio handling.
 - **"Echo Cancellor"** and **"Auto Gain Control"** should normally be set to **"ON"**. Changing either of these settings to **"OFF"** may result in degradation of the sound quality during a video conference call.
 - **"Output local site sound"** should normally be set to **"OFF"**.
 - When a mic is connected, feedback may occur if your voice is output through the TV speakers. In places where a mic is used, do not have your voice output through the speakers.
 - The items are displayed over 2 screens. You can move to the next or previous screen by pressing **[R]** or **[B]**, respectively.
1. Select **"Audio I/O"** and press **[ENTER]**.
 - The audio input/output settings screen is displayed.
 2. Use **[▲][▼]** to select the following items for input:
 - "Echo Cancellor"**: Use **[◀][▶]** to select whether to enable the echo canceller feature.
 - **"ON"** (default): Enables the echo canceller feature.
 - **"OFF"**: Disables the echo canceller feature.
 - "Auto Gain Control"**: Use **[◀][▶]** to select whether to enable the auto gain control feature.
 - **"ON"** (default): Enables the auto gain control feature.
 - **"OFF"**: Disables the auto gain control feature.

Note

- In order to set **"Auto Gain Control"**, the setting for **"Echo Cancellor"** must be **"OFF"**.

"RCA input gain for Audio": Press **[ENTER]** and use **[▲][▼]** to select the input gain for the Audio In L/R jack (-42 dB to +4 dB) (default: -32 dB).

Note

- The value set for **"RCA input gain for Audio"** will be applied when **"Auto Gain Control"** is set to **"ON"**.

"Audio output terminal": Press **[ENTER]** and use **[▲][▼]** to select audio output for during a video conference call.

- **"HDMI 1"** (default): Outputs audio from HDMI1.
- **"HDMI 2"**: Outputs audio from HDMI2.
- **"OFF"**: Audio is not output to HDMI.

Note

- When using a KX-VC1000 that has not been expanded for HDMI Dual Monitor support, **"HDMI 2"** is not displayed.
- In the image output settings, when **"Video Output"** is set to **"HDMI 1"**, **"HDMI 2"** is not displayed (Page 150).

"Output local site sound": Press **[ENTER]** and use **[▲][▼]** to select whether your own site's audio is output to its destination during a video conference call.

- **"OFF"** (default): Local site audio is not output.
- **"RCA"**: Local site audio is output through the Audio Out R jack.
- **"HDMI"**: Local site audio will be output to the HDMI(R) connection set in **"Audio output terminal"**. The other site's audio is output to HDMI(L).

"Microphone Equaliser": Press **[ENTER]**, and then use **[▲][▼]** to select the type of equalizer to be used.

- **"Normal Equaliser"** (default): A general-purpose equalizer is used.
- **"Solve blur Equaliser"**: An equalizer for improving blur in sound is used.
- **"Bass Equaliser"**: An equalizer for improving how bass is picked up is used.

"Microphone mute Mode": Press **[ENTER]**, and then use **[▲][▼]** to select the microphone to mute when a call starts.

- **"MIC-Headset-Audio In"** (default): The boundary microphone, headset microphone, and general-purpose microphone are muted.
- **"MIC-Headset"**: The boundary microphone and headset microphone are muted.

"Main Camera Audio input": Use **[◀][▶]** to select whether audio will be input from the main camera during a call.

- **"ON"**: Audio is input.
- **"OFF"** (default): Audio is not input.

Note

- For software versions lower than 4.50, **"Main Camera Audio input"** is displayed as **"Main Camera Audio input / call"**.

"HDMI Audio input / content": Press **[ENTER]** and then use **[▲][▼]** to select the HDMI terminal for audio input.

- **"OFF"**: Audio is not input.
- **"Main Camera"**: Audio is input from the main camera.
- **"Sub Camera"**: Audio is input from the sub camera.
- **"PC"** (default): Audio is input from PC-HDMI.
- **"Sub Camera + PC"**: Audio is input from the sub camera and PC-HDMI.

"HDMI input gain for Audio": Press [ENTER], and then select the audio input gain (+6 dB to -32 dB, "OFF") (default: 0 dB).

"Output gain for HDMI inp. Audio": Press [ENTER], and then select the audio output gain (+6 dB to -32 dB, "OFF") (default: 0 dB).

Note

- Even when audio input is set for **"Main Camera Audio input"** or **"HDMI Audio input / content"**, if **"HDMI input gain for Audio"** and **"Output gain for HDMI inp. Audio"** are set to **"OFF"**, audio will not be output.
- When **"Main Camera"** is selected for **"HDMI Audio input / content"**, set **"Main Camera Audio input"** to **"ON"**.
- When a video camera with a microphone is used, if **"Main Camera Audio input"** is set to **"ON"** and **"Output gain for HDMI inp. Audio"** is set to a setting other than **"OFF"**, feedback may occur.

3. Press [G].

- A dialogue box to confirm the saving of settings is displayed.

4. Use [◀][▶] to select **"Yes"** and press [ENTER].

- The administrator menu screen is displayed.

Making GUI Settings

1. Select **"GUI Settings"** and press [ENTER].

- The GUI settings screen is displayed.

2. Use [▲][▼] to select the following items for input:

Note

- The following items are displayed over 2 pages. To view all the items, press [R] to move to the next page, and press [B] to move to the previous page.
- **"Y" Button during MCU** is not displayed for the KX-VC1000.

- When using a KX-VC1000 that has not been expanded for 4 Point Built-in MCU support, the following items are not displayed.

- **"MCU Settings" Menu**
- **"Edit Profile"**

"Settings" Menu: Use [◀][▶] to select **"ON"** (default) or **"OFF"**.

- If you select **"OFF"**, the settings screen is not displayed even if you select **"Settings"** in the menu screen.

"Select local site" Menu: Use [◀][▶] to select **"ON"** (default) or **"OFF"**.

- If you select **"OFF"**, the select local site screen is not displayed even if you select **"Select local site"** in the menu screen.

"Network Settings" Menu: Use [◀][▶] to select **"ON"** (default) or **"OFF"**.

- If you select **"OFF"**, the network settings screen is not displayed even if you select **"Network Settings"** in the menu screen.

"Call set up" Menu: Use [◀][▶] to select **"ON"** (default) or **"OFF"**.

- If you select **"OFF"**, the connection settings screen is not displayed even if you select **"Call set up"** in the menu screen.

"Camera Settings" Menu: Use [◀][▶] to select **"ON"** (default) or **"OFF"**.

- If you select **"OFF"**, the video camera setting screen is not displayed even if you select **"Camera Settings"** in the menu screen.

"MCU Settings" Menu: Use [◀][▶] to select **"ON"** (default) or **"OFF"**.

- If you select **"OFF"**, the MCU setting screen is not displayed even if you select **"MCU Settings"** in the menu screen.

"Active Home Menu": Use [◀][▶] to select **"ON"** (default) or **"OFF"**.

- If you select **"OFF"**, the guide is not displayed in the Home screen. Pressing [FULL SCREEN] on the remote control will switch between displaying/hiding.

"Active Camera control Menu": Press [ENTER], use [▲][▼] to select **"Partially Hide"** (default) or **"Fully Hide"**.

- This setting determines the result when you press [FULL SCREEN] on the remote control to hide the guide area while using the camera control screen during a video conference.

- **"Partially Hide"**: Everything is hidden except for the control name and the remote control's colour button.
- **"Fully Hide"**: All of the guide area is hidden.

"Admin Login Disp. of "Y" Button": Use [◀] [▶] to select whether to display **"Admin Login"** in [Y] of the menu screen.

- **"ON"** (default): Displays **"Admin Login"**.
- **"OFF"**: Does not display **"Admin Login"**.

"Y" Button during MCU": Press [ENTER] and use [▲][▼] to assign a feature to the [Y] button during MCU.

- **"Whisper Mode"**: Turns Whisper Mode on and off.
- **"Discussion / Presentation"** (default): Switches the MCU mode.

"G" Button during call": Press [ENTER] and use [▲][▼] to assign a feature to the [G] button during calls.

- **"Aspect Ratio"** (default): Changes the incoming image aspect ratio during a 2-party video conference call.
- **"USB Rec"**: Starts and stops recording during a call.

"CAM CTRL" Button": Use [◀][▶] to select **"ON"** (default) or **"OFF"**.

- When **"OFF"** is selected, the [CAM CTRL] button cannot be used during a video conference call.

"Edit Contact list": Use [◀][▶] to select **"ON"** (default) or **"OFF"**.

- If you select **"OFF"**, items in the contact list cannot be added, edited, or deleted.

"Edit Profile": Use [◀][▶] to select **"ON"** (default) or **"OFF"**.

- If you select **"OFF"**, items in the profile cannot be added, edited, or deleted.

3. Press [G].
 - A dialogue box to confirm the saving of settings is displayed.
4. Use [◀][▶] to select **"Yes"** and press [ENTER].
 - The administrator menu screen is displayed.

Making HDMI Settings

1. Select **"HDMI Settings"** and press [ENTER].
 - The HDMI settings screen is displayed.

2. Use [▲][▼] to select the following items for input:
 - "One Touch Play"**: Use [◀][▶] to select **"ON"** or **"OFF"** (default).

Note

- Normally, select **"OFF"**. Changing this settings to **"ON"** may cause the image to change automatically depending on the model of the connected video camera.

"Standby": Use [◀][▶] to select **"ON"** (default) or **"OFF"**.

Note

- Depending on the connected video camera, changing this settings to **"ON"** may cause the video camera (Main, Sub) to synchronise and enter screen standby mode when the unit enters screen standby mode. Since operation may differ depending on your video camera model, contact your dealer for details.

3. Press [G].
 - A dialogue box to confirm the saving of settings is displayed.
4. Use [◀][▶] to select **"Yes"** and press [ENTER].
 - The administrator menu screen is displayed.

Setting Power Management

Power management can be set to automatically turn the HD Visual Communication Unit on or off at specified times. You can select to turn on or off at a specific day and time, or turn on or off at the same time every day.

Note

- A dialogue box to confirm turning off the unit is displayed about 60 seconds before the time set for automatic power off. Use [◀][▶] to select **"Yes"** or **"No"** and press [ENTER].
 - If you select **"Yes"**, the unit turns off without waiting for the set time.
 - If you select **"No"**, the unit will turn off at the next set time rather than the nearest set time.

If you do not press [ENTER] within 60 seconds, the unit will turn off at the set time.

- If the time set from automatic power off to automatic power on is less than 5 minutes, the unit will restart instead of turning off and on. In

such cases, the dialogue box to confirm whether to restart will not be displayed. Also, the unit will turn on automatically at the automatic power on time even if you turn it off manually before the unit restarts.

- Set the times so that the time from automatic power on to automatic power off is 5 minutes or longer.
- If the unit is already started at the automatic power on time, or if there is a call, recording, or firmware update at the automatic off time, the unit will turn on or off at the next set time.

1. Select **"Power Settings"** and press **[ENTER]**.
 - The power management settings screen is displayed.
2. Use **[▲][▼]** to select the following items for input:

Note

- To turn on (or off) on a specific day, set **"Day Setting"** to **"ON"**, **"Auto Power ON"** (or **"Auto Power OFF"**) to **"ON"**, **"Day (Power ON)"** (or **"Day (Power OFF)"**), and **"Time (Power ON)"** (or **"Time (Power OFF)"**).
- To turn on (or off) at the same time every day, set **"Day Setting"** to **"OFF"**, **"Auto Power ON"** (or **"Auto Power OFF"**) to **"ON"**, and **"Time (Power ON)"** (or **"Time (Power OFF)"**).

"Day Setting": Use **[◀][▶]** to select **"ON"** or **"OFF"** (default).

"Auto Power ON": Use **[◀][▶]** to select **"ON"** or **"OFF"** (default).

"Day (Power ON)": Press **[ENTER]** and use **[▲][▼]** to select a day (default: **Monday**).

Note

- You cannot set this if **"Day Setting"** is **"OFF"** or **"Auto Power ON"** is **"OFF"**.

"Time (Power ON)": Set a time (default: 06:00).

Note

- You cannot set this if **"Auto Power ON"** is **"OFF"**.

"Auto Power OFF": Use **[◀][▶]** to select **"ON"** or **"OFF"** (default).

"Day (Power OFF)": Press **[ENTER]** and use **[▲][▼]** to select a day (default: **Saturday**).

Note

- You cannot set this if **"Day Setting"** is **"OFF"** or **"Auto Power OFF"** is **"OFF"**.

"Time (Power OFF)": Set a time (default: 00:00).

Note

- You cannot set this if **"Auto Power OFF"** is **"OFF"**.

3. Press **[G]**.
 - A dialogue box to confirm saving the settings is displayed.
4. Use **[◀][▶]** to select **"Yes"** and press **[ENTER]**.
 - The administrator menu screen is displayed.

Note

- If you start the unit manually right before the automatic power off set time, it may not turn off at the set time. In such cases, it will turn off at the next set time.

Setting Shortcuts

You can quickly access system setting screens by setting shortcuts to remote control keys.

1. Select **"Shortcut Settings"** and press **[ENTER]**.
 - The shortcut settings screen is displayed.
2. Use **[▲][▼]** to select the following items for input: **"[B] Shortcut"** (default: **"Call History"**)/**"[R] Shortcut"** (default: **"Contact List"**)/**"[G] Shortcut"** (default: **"Profile"**)/**"[Y] Shortcut"** (default: **"—"**): Press **[ENTER]** and use **[▲][▼]** to select the function you want to set.
 - **"—"**: The shortcut key is not set.
 - The following screens can be set.
Call History/Contact List/Profile/System Settings/Set Date/Time/Network Settings/Call set up/MCU Settings/One-Touch Set./Standby Setting/Sound Settings/MIC Setting/Remote Ctrl ID/Camera Settings/Language Setting/USB Rec Settings/Multicast Setting/USB Device Mode/Enhancement/Network Test/Self Diag./Remote access

Note

- Items set to **"OFF"** in **"GUI Settings"** are also displayed.
- When using a KX-VC1000, **"MIC Setting"** is not displayed as a selection. Additionally, when using a KX-VC1000 that has not been expanded for 4 Point Built-in MCU support, **"Profile"** and **"MCU Settings"** are not displayed.

- For software versions lower than 4.50, the default for all shortcut keys is "—".
3. Press [G].
 - A dialogue box to confirm the saving of settings is displayed.
 4. Use [◀][▶] to select "Yes" and press [ENTER].
 - The administrator menu screen is displayed.

Setting Local Site Selection

1. Select "Select local site set" and press [ENTER].
 - The local site selection settings screen is displayed.
2. Use [▲][▼] to select the following items for input:
 - "Same setting after restart": Select whether to use the same local site after restarting.
 - "ON": The local site settings made before restarting will be retained.
 - "OFF" (default): The local site settings made before restarting will not be retained.
 - "Edit Local site": Select whether to enable the editing feature on the select local site screen.
 - "ON" (default): The editing feature is enabled.
 - "OFF": The editing feature is disabled.

Note

- If "OFF" is selected, you cannot add, edit, or delete a local site.

3. Press [G].
 - A dialogue box to confirm the saving of settings is displayed.
4. Use [◀][▶] to select "Yes" and press [ENTER].
 - The administrator menu screen is displayed.

Setting Multicast Tree

Perform settings for the multicast function (Page 172).

Exporting Data

The call log, operation log, and contacts list can be saved on a USB memory device. The saved operation log can be used to specify the cause when problems occur. For details, contact your dealer.

Note

- A mass storage class (FAT16 or FAT32 format) compatible USB memory device can be used with this unit.
 - The following types of USB memory devices cannot be used:
 - U3 smart drives (USB memory devices compatible with the U3 platform)
 - USB memory devices with security features
 - USB memory devices formatted using NTFS
 - USB memory devices with multiple LUNs (Logical Unit Numbers)
 - USB memory devices formatted with multiple partitions
 - USB memory devices are not guaranteed to fully operate. For details, contact your dealer.
 - To re-connect a USB memory device, make sure to fully remove the USB memory device before connecting it again.
 - Confirm the USB memory device has sufficient free space (at least 50 MB) before using it.
1. Connect the USB memory device to the USB jack on the back of the unit (Page 23).

Note

- Make sure that the USB memory device is connected correctly.

2. Select "Export data" and press [ENTER].
 - The data export screen is displayed.

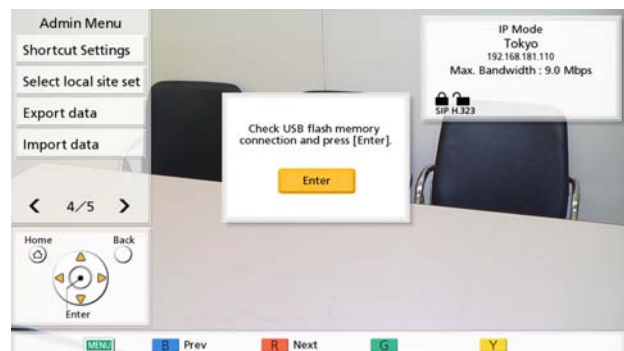

3. Press [ENTER].
 - The data export begins.

Note

- While the data is being exported, do not remove the USB memory device. This could damage the unit or corrupt the data.

- The data saved to the USB memory device will be named "hdvclogall_XXXX.tar". The "XXXX" portion of the file name varies depending on the software version and date of the export.
- The contacts list (address.xml), profile (profile.xml), configuration data (config.xml), encryption data (sec_config.xml), and multicast tree list (alm_config_list.xml) that are included in the file "hdvclogall_XXXX.tar" can be imported into the unit. However, when using a KX-VC1000 that has not been expanded for 4 Point Built-in MCU support, profile (profile.xml) cannot be imported.
- For information about editing the exported contacts list (address.xml) or profile (profile.xml), contact your dealer.

4. Check the result (successful/failed) and press **[ENTER]**.
 - The administrator menu screen is displayed.

5. Remove the USB memory device.

Note

- To prevent data leakage from the USB memory device, make sure to erase all data from the USB memory device before disposing of, lending, or returning it.

Importing Data

The contacts list and other data exported from the unit can be re-imported from a USB memory device.

Note

- Encryption data exported from the unit includes login IDs and passwords. Note that when encryption data is imported, login IDs and passwords may change and login can no longer be performed.
- When importing data that was exported from a unit that had profile standby set to **"Permanent"**, import the profile and configuration data together.
- When importing data that was export from the unit that registered the local site information (Page 113), import encryption data and configuration data.

- A mass storage class (FAT16 or FAT32 format) compatible USB memory device can be used with this unit.
- The following types of USB memory devices cannot be used:
 - U3 smart drives (USB memory devices compatible with the U3 platform)
 - USB memory devices with security features
 - USB memory devices formatted using NTFS
 - USB memory devices with multiple LUNs (Logical Unit Numbers)
 - USB memory devices formatted with multiple partitions
- USB memory devices are not guaranteed to fully operate. For details, contact your dealer.
- To re-connect a USB memory device, make sure to fully remove the USB memory device before connecting it again.
- You can import a startup screen to change the default startup screen.

1. Prepare the USB memory device that contains the data that will be imported.
 - The file names of the files that can be imported are fixed as follows.
 - Contacts list: address.xml
 - Profile: profile.xml
 - Configuration data: config.xml
 - Encryption data: sec_config.xml
 - Startup screen: startup.png
 - Multicast tree list: alm_config_list.xml
 - Store the data to be imported in the root directory of the USB memory device, or in a folder stored in the root directory (folder names: 01–16).
 - For the startup screen, use the PNG file format for an image that is 960 × 540 pixels or smaller.

Note

- When using a KX-VC1000 that has not been expanded for 4 Point Built-in MCU support, profile (profile.xml) cannot be imported.

2. Connect the USB memory device to the USB jack on the back of the unit (Page 23).

Note

- Make sure that the USB memory device is connected correctly.

3. Select **"Import data"** and press [ENTER].
 - The data import screen is displayed.
4. Use [▲][▼] to select the following items for input:
"USB Directory": Press [ENTER] and use [▲][▼] to specify the directory that contains the data, from **"root"** (default), or **"/01"–"/16"**.
"Data": Press [ENTER] and use [▲][▼] to specify the data that will be imported, from **"All Data"**, **"Contact List"**, **"Profile"**, **"Configuration Data"**, **"Encryption Data"**, **"Startup screen"**, or **"Multicast Tree List"**.

Note

- When using a KX-VC1000 that has not been expanded for 4 Point Built-in MCU support, **"Profile"** is not displayed as an available selection.

5. Press [G].
 - A dialogue box is displayed asking you to confirm the import and that unit will restart after the import.
6. Use [◀][▶] to select **"Yes"** and press [ENTER].
 - The unit restarts so that the imported data can be applied.

Note

- If the image file is larger than 960 × 540 pixels in size, the default startup screen will be displayed.
- If the image file is smaller than 960 × 540 pixels in size, it will be displayed centered on the screen.

Activating Enhanced Features

You can activate features by enhancing the unit's software. To activate the feature, you must obtain a registration key from your dealer. First, provide your dealer with the Activation Key No. and Registration ID written on the activation key, and the unit's MPR ID. The dealer will enter this information into the Key Management System and then issue you with the registration key.

To Confirm the MPR ID

1. Select **"Enhancement"** and press [ENTER].
 - The software enhancement screen is displayed. Check the field **"MPR ID"**.

To Register the Registration Key

Registering the registration key you acquired activates the enhanced features.

1. Select **"Enhancement"** and press [ENTER].
 - The software enhancement screen is displayed.

Note

- In **"KX-VC Series NAT Traversal Service"**, the registration status of the KX-VC Series NAT Traversal Service is displayed.
 - **"Not registered"**: The service is not registered or more than 6 months have passed since the expiration date.
 - **"Expired"**: Less than 6 months have passed since the service expiration date. The service period can be extended.
 - **"Expiration date is <Day/Month/Year> (GMT)"**: The service has been registered.
 - **"Not connected to the NAT Traversal server"**: Due to problems such as not being connected to the network or other network problems, the NAT Traversal server could not be connected to. Once communications are established with the server, the status will automatically change to service registered status.
- Features that have already been activated are displayed in **"Activated Features"**, as follows:
 - **"4 Point Built-in MCU"**: An expansion feature is enabled for the built-in MCU. (For the KX-VC1000, 2 parties are expanded to 4 parties. For the KX-VC1600, 6 parties are expanded to 10 parties. For the KX-VC2000, 16 parties are expanded to 20 or 24 parties. When the KX-VC2000 is expanded to 24 parties, **"4 Point Built-in MCU"** is displayed in 2 lines.)
 - **"Multicast"**: The multicast enhanced feature is enabled.
 - **"Mobile Connection"**: The mobile connection enhanced feature is enabled.
 - **"HDMI Dual Monitor"**: HDMI2 is available for the KX-VC1000.
 - **"PC Peripheral"**: PC Peripheral is enabled.

- **"None"**: No features have been activated.

2. Press **[G]**.
 - The registration key input screen is displayed.
3. Enter the 16-digit registration key.
4. Press **[G]**.
 - A dialogue box to confirm the saving of settings and system restart after saving is displayed.
5. Use **[◀][▶]** to select **"Yes"** and press **[ENTER]**.
 - The system will automatically restart to reflect changes to system settings.

Note

- If the registration key you entered is invalid, **"Failed Registration Key code authentication."** is displayed. Repeat the procedure from step 3. If this message is displayed even when you have correctly input the registration key that was issued, contact your dealer.
- Only one registration key can be registered at once. To register multiple registration keys for enabling multiple features, a restart is necessary for each registration.
- Activated features can also be checked on the enhanced feature confirmation screen (Page 133).

Updating Software

Note

- If you want to update software using a USB memory device, consult your dealer.
- When updating software using a USB memory device, note the following.
 - Save the software update file in the root directory of the USB memory device.
 - Do not change the name of the software update file.
 - Connect the USB memory device to the USB jack on the back of the unit ahead of time.

1. Select **"Software update"** and press **[ENTER]**.
 - The software update screen is displayed.

2. Use **[▲][▼]** to select **"Update Method"** and press **[ENTER]**.
3. Use **[▲][▼]** to select **"Network"** or **"USB"** and press **[ENTER]**.
 - **"Network"**: Updates the software from the network.
 - **"USB"**: Updates the software from a USB memory device.

Note

- If you want to select **"USB"**, contact your dealer for the details.

4. When **"Automatic Version Check"** is set to **"ON"** (Page 141):

The latest software version is displayed next to **"Available Software version :"**. Proceed to step 5 if there is an update available.

When **"Automatic Version Check"** is set to **"OFF"** (Page 141) or when **"Update Method"** is set to **"USB"** in step 3:

Use **[▲][▼]** to select **"Version Confirmation"** and press **[ENTER]**.

- The system checks for version updates. The latest software version will be displayed next to **"Available Software version :"**. Proceed to step 5 if there is an update available.

5. Use **[▲][▼]** to select **"Update Software Now"** and press **[ENTER]**.
 - A dialogue box to confirm the updating of your software is displayed.

Note

- Please carefully read and confirm the cautions in the dialogue box before proceeding to the next step.

6. Use **[◀][▶]** to select **"Yes"** and press **[ENTER]**.
 - The update is automatically downloaded and installed.
 - To complete the update, the system will automatically restart. Before restart, a message will be displayed as detailed below.

The message displayed before the restart

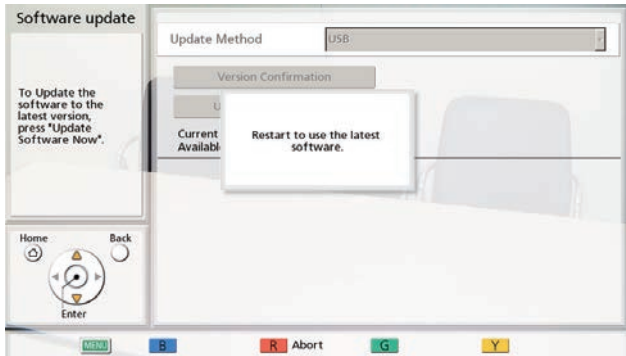

After the restart, the system will start up with the latest software.

Note

- Contact your dealer for more information on obtaining the latest firmware and User Manual.
- If the checking, downloading, or installing of a software update fails, an error message is displayed. Press [ENTER] to restart the system.

Please try the following:

- a. Check the settings for "DNS Server" or "Primary DNS Server" in network settings (Page 118). Then, try updating the software again.

When "DNS Server" is set to "Auto", the DHCP server may be the cause of the problem. In this case, contact your network administrator.

- b. If the above step is unsuccessful, try updating the software again later. The network may be currently very busy.

If the retry fails several times, there might be a problem with your communication lines. Please contact your dealer.

- Software cannot be updated when using IPv6 addresses.

Initialising a Video Camera

Note

- Initialisation is available only for video cameras connected to your unit and only when you are not on a video conference call.
- For details about compatible video camera models, contact your dealer.

1. Select "Camera Initialize" and press [ENTER].
 - The video camera initialisation screen is displayed.
2. Use [◀][▶] to select the video camera to be initialised ("Main" [default] or "Sub").
3. Press [R].
 - A dialogue box confirming whether you want to start the video camera initialisation is displayed.
4. Use [◀][▶] to select "Yes" and press [ENTER].
 - After the initialisation is complete, the administrator menu screen is displayed.

Performing System Initialisation

1. Select "System Initialize" and press [ENTER].
 - A dialogue box confirming whether you want to start the system initialisation is displayed.
2. Use [◀][▶] to select "Yes" and press [ENTER].
 - The system will automatically restart to complete the system initialisation.

Note

- After initialisation, all system settings previously made and information stored in the contact list, profile, local site, and call history are cleared.
- The updated startup screen data has been damaged due to a data import operation (Page 157).
- Features activated due to software enhancement (Page 158) are not cleared.

Setting Remote Access

You can set the settings required to remotely access the unit.

Note

- Changes made to the **"Web port permanently enabled"**, **"Web port Number"**, **"telnet port permanently enabled"**, and **"telnet port Number"** settings are applied after restarting the unit.
1. Select **"Remote access Set."** and press [ENTER].
 - The remote access setting screen is displayed.
 2. Use [▲][▼] to select the following items for input.

"Change Password": Use [◀][▶] to select whether to change the password from the default.

 - **"ON"**: Changes the password.
 - **"OFF"** (default): Does not change the password.

Note

- This password is used for controlling the unit remotely, and is different from the password used for administrator login (page 140).

"Current password": Enter the current password (default: HDVC_admin).

"New password": Enter the new password.

"Retype new password": Enter the new password again.

Note

- Passwords must be from 8 to 32 characters in length, and be comprised of at least 2 types of characters from the alphabet, numbers, and symbols.
- The default password (HDVC_admin) cannot be entered for **"New password"**.
- Take care with managing the password.
- Passwords cannot be entered when **"Change Password"** is set to **"OFF"**.

"Web port permanently enabled": Use [◀][▶] to select whether to permanently enable the web port.

- **"ON"**: Permanently enables the web port.
- **"OFF"** (default): Does not permanently enable the web port.

Note

- When **"ON"** is selected, the password must be changed from the default.
- When **"ON"** is selected, the unit can be permanently accessed remotely via a web port. Take precautions against unintended access by doing actions such as periodically changing the password.

"Web port Number": When the web port is permanently enabled, set the port number (80, 8000 to 8999). (Default: 80)

"telnet port permanently enabled": Use [◀][▶] to select whether to permanently enable the telnet port.

- **"ON"**: Permanently enables the telnet port.
- **"OFF"** (default): Does not permanently enable the telnet port.

Note

- When **"ON"** is selected, the password must be changed from the default.
- When **"ON"** is selected, the unit can be permanently accessed remotely via a telnet port. Take precautions against unintended access by doing actions such as periodically changing the password.

"telnet port Number": When the telnet port is permanently enabled, set the port number (23, 20000 to 29999). (Default: 23)

3. Press **[G]**.
 - A dialogue box to confirm the saving of settings is displayed.
4. Use **[◀][▶]** to select "**Yes**" and press **[ENTER]**.
 - The administrator menu screen is displayed.

Using the KX-VC Series NAT Traversal Service

Preparations for Connections

Service Period Overview

To use this service, registration is necessary. By registering using the activation key included with the product, you can use this service for 3 months at no charge. The service period starts as soon as registration is complete (i.e., after completing the procedure explained in "Activating Enhanced Features (Page 158)"). The service period will be effective on the whole day (until midnight when the date changes) 3 months from the start of the service period.

Example 1: Registration is completed on April 1



Example 2: Registration is completed on December 15

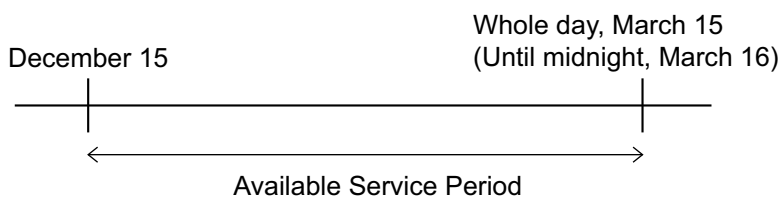

Note

- You can check the service expiration date using the unit. For details, see "**Checking Enhanced Features (Page 133)**".

To continue using this service after the trial service period has ended, you must purchase an activation key to extend the service period. The length of the service period depends on the card. For details about the card, contact your dealer.

For details about the procedure for extending the service period, see "**Extending the Service Period (Page 168)**".

Security Overview

This service uses a standard Internet connection, so if encryption is not enabled, it is possible for others to listen in on your conversation. It is strongly recommended that you enable encryption when you use this service. For details about enabling encryption, see "**Making Encryption Settings (Page 140)**".

KX-VC Series NAT Traversal Service Setup Procedure

This is the procedure required for setting up operation of the KX-VC Series NAT Traversal Service. See each setting item for details.

- 1 Set up the Operating Environment (Page 165)



- 2 Obtain a Registration Key (Page 165) (using a computer)



- 3 Perform the settings necessary for using the KX-VC Series NAT Traversal Service (Page 142). (Unit operations)



- 4 Register the Registration Key (Page 158) (using the unit)



- 5 Video conference call over KX-VC Series NAT Traversal Service



- 6 Extend the Service Period of KX-VC Series NAT Traversal Service (Page 168) (using a computer)

Note

- Operations in "**Obtain a Registration Key (Page 165)**" and "**Extending the Service Period (Page 168)**" must be performed by your dealer. For details, contact your dealer.

Connect to the Internet

To use KX-VC Series NAT Traversal Service, a network environment and devices that meet the following specifications are necessary.

Network Environment

To use KX-VC Series NAT Traversal Service to establish video conference calls, a broadband connection is required. (A 3-party video conference call requires a 1.0 Mbps connection, and a 4-party video conference call requires a 2.0 Mbps connection.)

Router

Please use a router that has been tested by Panasonic for use with this service, and use the information from your provider to connect to the Internet. For details about tested routers, refer to the following web site: https://panasonic.net/cns/psn/products/hdvc/nat/nat_traversal/index.html
For details about configuring your router, refer to the router's documentation.

To connect the unit and router

1. Connect the router to the LAN1 jack on the back of the unit.
 - Connect a router to the LAN1 jack on the back of the unit using a category 5 or greater LAN cable. (For the LAN1 jack position, refer to "Main Unit (Back)" in "Part Names and Usage (Page 22)".)

Note

- Operation cannot be guaranteed in the following cases:
 - You are using a router other than one tested by Panasonic.
 - Multiple HD Visual Communication Units are connected to one router.
 - The HD Visual Communication Unit is connected directly to the Internet, and not through a router.

Obtain a Registration Key

In this procedure, you will use a computer to access the KX-VC Series NAT Traversal Service registration page and obtain a Registration Key. The following information is necessary:

- **MPR ID**
 - This can be confirmed on the label on the bottom of the unit or through operating the unit. For details, see "To check the MPR ID (using the unit) (Page 165)".
- **Activation Key No.**
 - Recorded on an activation key.
- **Registration ID**
 - Recorded on an activation key.

To check the MPR ID (using the unit)

1. Press [MENU].
 - The Menu screen is displayed.
2. Use [▲][▼] to select "Settings" and press [ENTER].
 - The system settings screen is displayed.
3. Press [◀][▶] to display the fourth page.
4. Use [▲][▼] to select "Enhancement" and press [ENTER].
 - The enhanced feature confirmation screen is displayed. Check the field "MPR ID" (❶).



5. Press [Home].
 - The Home screen is displayed.

To obtain a Registration Key (using a computer)

Note

- The following operating systems and web browsers are supported:
 - Microsoft Windows 7 operating system
 - Microsoft Windows Internet Explorer 8/10 web browser
 - Microsoft Windows 8 operating system
 - Internet Explorer 10
 - Mozilla® Firefox® web browser
- From a computer, access the KX-VC Series NAT Traversal Service registration page (<https://www2.tsunagarunet.com/hdcom/main>).
 - The login screen is displayed.

Note

- The login screen is displayed in English. You can change the language from the drop-down list in the upper right of the screen.
- Enter the characters displayed in the image, and then click **"Apply"**.



- The function selection screen is displayed.

Note

- The fields are case sensitive.

- Click **"Apply new"** next to HDVC.

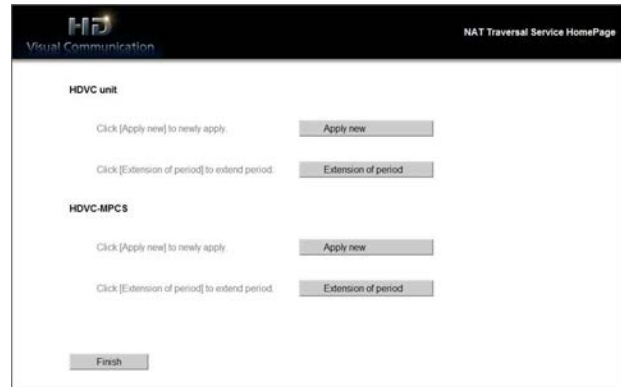

- The new application screen is displayed.

- Fill in the following items:

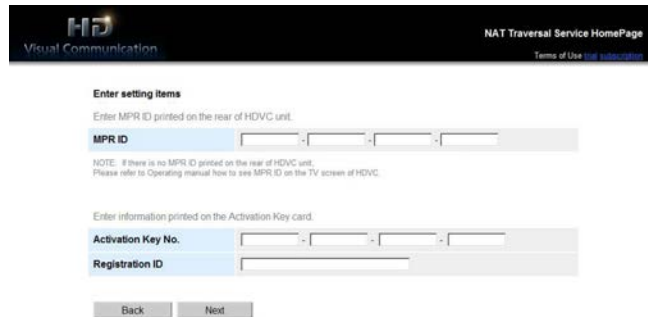

- "MPR ID"**
- "Activation Key No."**
- "Registration ID"**

- Click **"Next"**.
 - The Terms of Use screen is displayed.
- Read the Terms of Use thoroughly, and if you agree to the terms, click **"Accept"**.
 - The Terminal ID selection screen is displayed.
- Select the Terminal ID you want to use, and then click **"Next"**.



- The information confirmation screen is displayed.

Note

- Clicking "**Click to Show next Terminal IDs**" displays more Terminal IDs available for use. You can repeat this operation up to 5 times. Once you click "**Click to Show next Terminal IDs**", Terminal IDs that have been displayed up to that point cannot be recalled.

8. Click "Register".

- The value displayed on the screen in "**Registration Key**" (16 characters) must be registered to the unit. Make a printout of the page or write down the Registration Key on the activation key or another piece of paper and store it in a safe place.

Terminal ID	000000
Registration Key	000000-000000-000000-000000
Expiration date	1 year(s) after first use of NAT traversal service.

IMPORTANT

- If you misplace the Registration Key information, refer to "To display the Registration Key again (using a computer) (Page 167)".

9. Click "Menu".

- The function selection screen is displayed.

To display the Registration Key again (using a computer)

If you misplace the Registration Key information, you can display it again by following the procedure below.

- From a computer, access the KX-VC Series NAT Traversal Service registration page (<https://www2.tsunagarunet.com/hdcom/main>).
 - The login screen is displayed.

Note

- The login screen is displayed in English. You can change the language from the drop-down list in the upper right of the screen.

- Enter the characters displayed in the image, and then click "**here**" at the bottom of the screen.

- The unit information login screen is displayed.

Note

- The fields are case sensitive.

- Fill in the following items:

"Type": select HDVC

"MPR ID"

**"Activation Key No."
"Registration ID"**

4. Click **"Next"**.
 - The unit information screen is displayed. Check the **"Registration Key"** information on the screen. When you are finished, close the browser.



Extending the Service Period

To extend the service period, it is necessary to purchase an activation key. The duration of the extension differs according to the card purchased. For details about cards, contact your dealer.

Note

- If the service period is extended while the service period is still in effect, the duration of the extension is added to the current service period. Example: During a 3-month duration service period, the service period is extended by 1 year.

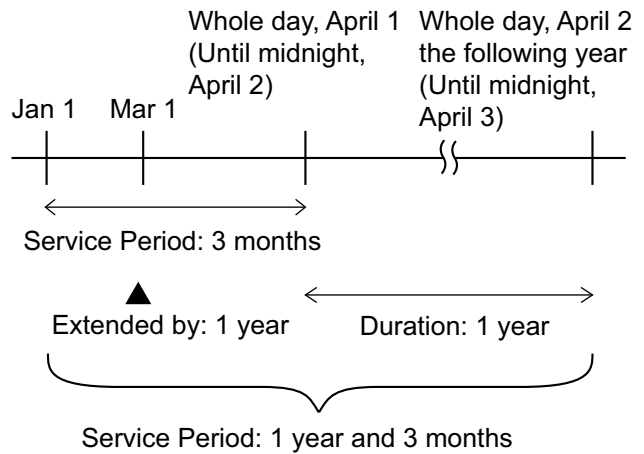

- If the service period is extended within 6 months following the expiration of a service period, the service period begins at the time the extension is performed.

1. From a computer, access the KX-VC Series NAT Traversal Service registration page (<https://www2.tsunagarunet.com/hdcom/main>).
 - The login screen is displayed.

Note

- The login screen is displayed in English. You can change the language from the drop-down list in the upper right of the screen.

- Enter the characters displayed in the image, and then click **"Apply"**.

- The function selection screen is displayed.

Note

- The fields are case sensitive.

- Click **"Extension of period"** next to HDVC.

- The extension of period screen is displayed.

- Fill in the following items:

"MPR ID": Input the MPR ID of the unit that you want to extend the service period for.

"Activation Key No.": Input the Activation Key No. printed on the activation key purchased for the service period extension.

"Registration ID": Input the Registration ID printed on the activation key purchased for the service period extension.

- Click **"Next"**.
 - The Terms of Use screen is displayed.
- Read the Terms of Use thoroughly, and if you agree to the terms, click **"Accept"**.
 - The extension confirmation screen is displayed.
- Click **"Register"**.

- The extension completion screen is displayed.

Note

- To register another activation key, click **"Register New"** and repeat steps 4 to 7.
- The total amount of the service period that can be registered using activation keys at one time is 6 years, which includes the amount of time remaining in the currently active service period. An activation key cannot be registered if doing so would extend the total service period beyond 6 years.

- Click **"Menu"**.
 - The function selection screen is displayed.
- Press the unit's power button to turn it off, and then on to restart the unit.
 - The extended service period is reflected on the unit.
- Press **[MENU]**.
 - The Menu screen is displayed.
- Use **[▲][▼]** to select **"Settings"** and press **[ENTER]**.
 - The system settings screen is displayed.

12. Press [▶] three times.
 - The fourth page is displayed.
13. Use [▲][▼] to select "**Enhancement**" and press [ENTER].
 - The enhanced feature confirmation screen is displayed. Check the field "**KX-VC Series NAT Traversal Service**", and confirm that the service period has been extended.
14. Press [Home].
 - The Home screen is displayed.

Using Mobile Connection Enhanced Features

When mobile connection is enabled for an HD Visual Communication Unit using an activation key, the mobile devices can connect to the unit, but enhanced features for mobile devices are not enabled (Page 158).

Conditions for connecting an HD Visual Communication Unit to a mobile device

	When Using Mobile Connection	When not Using Mobile Connection	
Required Enhanced Features	HD Visual Communication Unit: mobile connection Mobile device: none	HD Visual Communication Unit: NAT Traversal Mobile device: NAT Traversal	HD Visual Communication Unit: none Mobile device: NAT Traversal
Connection modes usable for communication	IP Mode IP/NAT Traversal Mode (using IP Mode)	IP Mode NAT Traversal Mode IP/NAT Traversal Mode	IP Mode IP/NAT Traversal Mode (using IP Mode)

Maximum number of mobile devices that can connect using mobile connection

- KX-VC1000: 1 unit
- KX-VC1000 (when using the 4 Point Built-in MCU enhanced feature): 3 units
- KX-VC1300: 3 units
- KX-VC1600: 5 units
- KX-VC1600 (when using the 4 Point Built-in MCU enhanced feature): 9 units
- KX-VC2000: 15 units
- KX-VC2000 (when using the 4 Point Built-in MCU enhanced feature): 19 units
- KX-VC2000 (when using the 4 Point Built-in MCU enhanced feature 2 times): 23 units

Note

- In order to use mobile connection with a connectable mobile device, its software version must be 3.10 or later.
- In this manual, "HDVC Mobile" refers to a mobile device that uses enhanced features to connect with the HD Visual Communication Unit.

Using Multicast

About Multicast

Multicast is a one-way communication service that allows one HD Visual Communication Unit to multicast video and audio to other multiple units, which receive the communication and show it.

The data received and shown by a unit can also be sent along to other units, as the receiving unit can function as a relay terminal. Each unit can relay data to 2 other units, and in a configuration with 5 layers of relays, a system of 31 units can be established.

A multicast system is composed of the following terminals.

- Multicast terminal: The top-level terminal that multicasts video and audio
- Relay terminal: Receives video and audio from a higher-level terminal and relays it to a lower-level terminal. (The received contents are also shown at the relay terminal.)
- Receiver terminal: Receives video and audio.

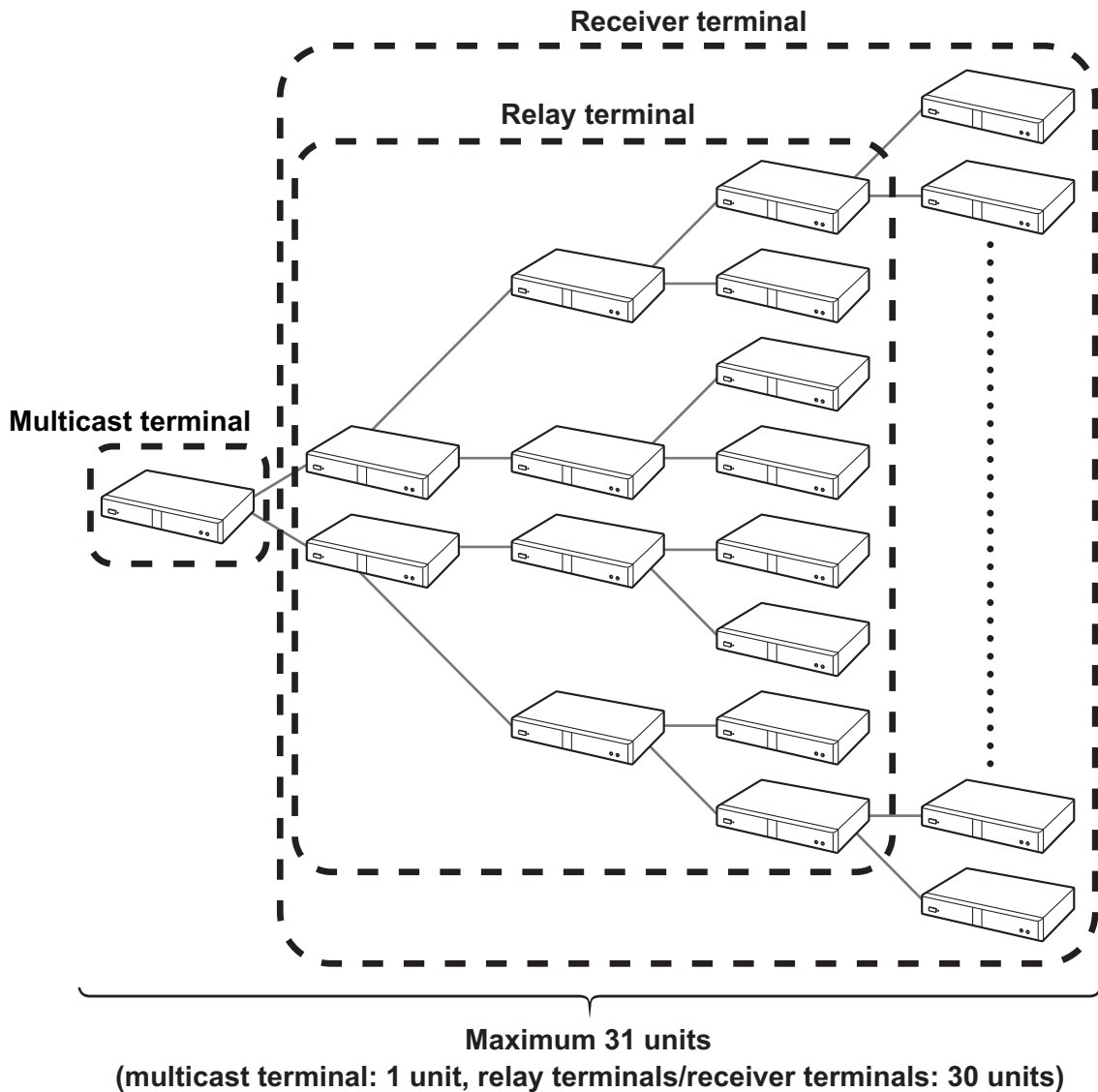

The multicast feature, compared to usage of an MCU, can reduce the network bandwidth used at the multicast terminal's sites. When a transmission failure occurs during the multicast, the configuration of the terminals will automatically change, so it is necessary that all terminals can connect and communicate with each other over the network.

Note

- In order to use the multicast feature, all HD Visual Communication Units that will comprise the multicast system must have a Multicast activation key (KX-VCS302) installed.
- The multicast feature will not operate when using IPv6 addresses.
- To enable **"Multicast"** in **"Enhancement"**, be sure to assign an IPv4 address to the unit in **"Network Settings"**. In cases where an IPv4 address is not assigned, such as when **"IP Address (LAN 1)"** (setting) is set to **"Auto"**, but the status **"Address is not assigned"** is displayed, communication using an IPv6 address cannot occur.
- The multicast feature will not operate when using IP Mode (H.323).
- The multicast feature will not operate when using NAT Traversal Mode.
- The multicast data cannot be encrypted.
- Connection using a SIP server cannot be performed.
- When configuring a system of 32 or more units, a multicast server is required. For details, contact your dealer.

Multicast Operation

Starting Multicast

In order to perform multicasting, multicast tree settings must first be set (Page 174, Page 175). When the multicast is started from the multicast tree setting screen, connections are established with the lower level terminals and then the multicast will begin (Page 179).

If a lower-level terminal's power is not on, or there is a network failure, and there is no response for the connection confirmation, the configuration of the multicast tree will automatically change, and then the multicast will begin. If a terminal that was removed from the configuration at startup responds with a connection confirmation during the multicast, the multicast tree will automatically re-add the terminal and multicast data to it.

Ending the Multicast

Press **[END]** at the multicast terminal to end the multicast.

Handling of Trouble During a Multicast

If a relay terminal loses its ability to connect to the multicast due to problems such as network trouble, the multicast tree will automatically adjust and continue the multicast.

The Multicast Tree

Set the multicast tree to perform the multicast. The multicast tree defines the positions of terminals within the multicast system. The position of terminals within the multicast tree are displayed using node IDs, and their positional relationships are as follows.

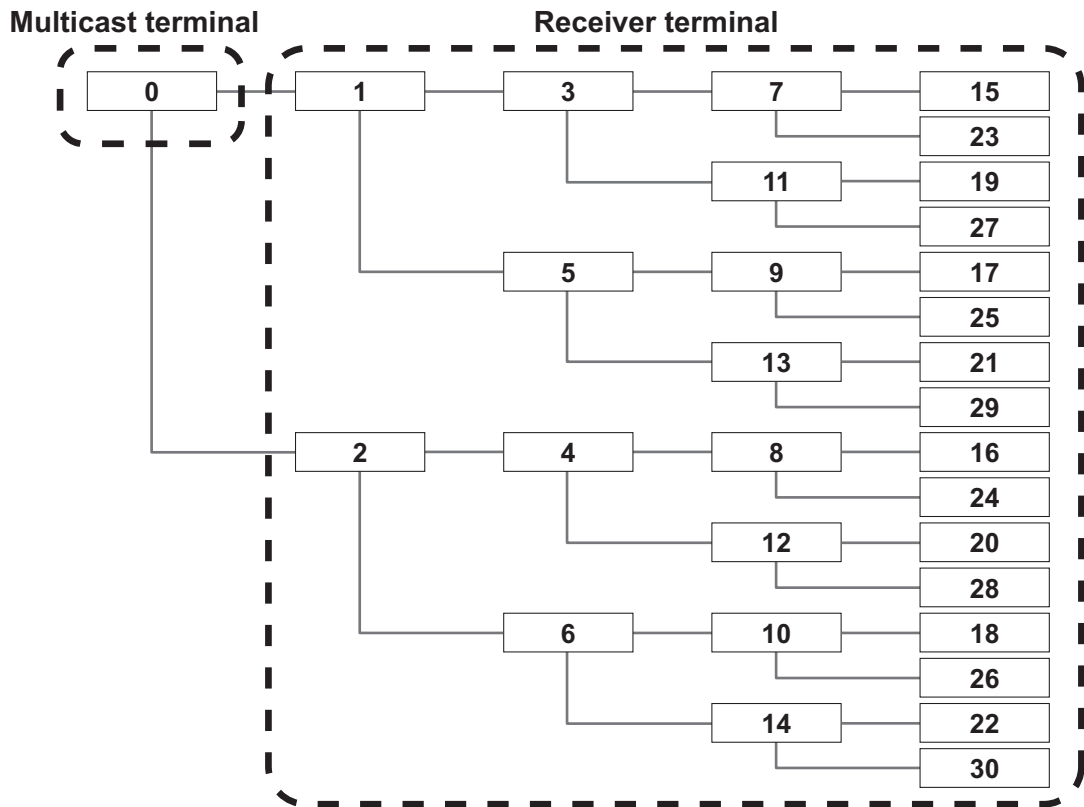

About the Network

The multicast terminal and relay terminals multicast data to up to 2 terminals, so all terminals in the multicast system must have bandwidth twice that of the multicast maximum bandwidth (1/1.2/2/3/4/5 Mbps). The recommended resolutions for the multicast maximum bandwidth are as follows.

Maximum bandwidth	Maximum resolution	
	Full HD (1080/30p)	HD (720/60p)
5 Mbps	recommended	
4 Mbps	recommended	
3 Mbps	recommended	
2 Mbps	recommended	recommended
1.2 Mbps		recommended
1 Mbps		recommended

Note

- During the multicast, if the connection bandwidth drops, the sending bandwidth will drop as well, lowering the resolution and/or the frame rate.
- The quality of the multicast video and audio is affected by packet round trip time (RTT), the packet loss ratio, and the number of packets re-sent. Terminals store approximately 1 second of data for resending, but if sending/receiving is delayed beyond this, the image may become corrupted. For details on network design that takes into account issues such as round trip time and the packet loss ratio, contact your dealer.

Setting the System

Setting Multicast

1. In step 3 of "Changing System Settings/Performing System Maintenance (Page 115)", select **"Multicast Setting"** and press [ENTER].
 - The multicast setting screen is displayed.
2. Press [ENTER] and use [▲][▼] to select the microphone of the multicast terminal to use for the multicast feature.
 - **"MIC·Audio In"** (default): Audio is input from both the Boundary Microphone and the RCA inputs.
 - **"Audio In"**: Audio is input from the RCA inputs.

Note

- **"Multicast Setting"** can be configured when **"Multicast"** in **"Enhancement"** is enabled.

Making Administrator Menu Settings

Registering the Multicast Tree

Sets the terminals and multicast conditions registered for the multicast tree. Up to 10 multicast trees can be registered.

Note

- **"Multicast Tree Set."** is available when **"Multicast"** is enabled for **"Enhancement"**.

New Registration

1. In step 7 of "Administrator Menu List (Page 136)", select **"Multicast Tree Set."** and press [ENTER].
 - The multicast tree screen is displayed.
2. Use [▲][▼] to select **"Not Registered"**.

- 3. Press [B].
 - The multicast tree setting screen is displayed.

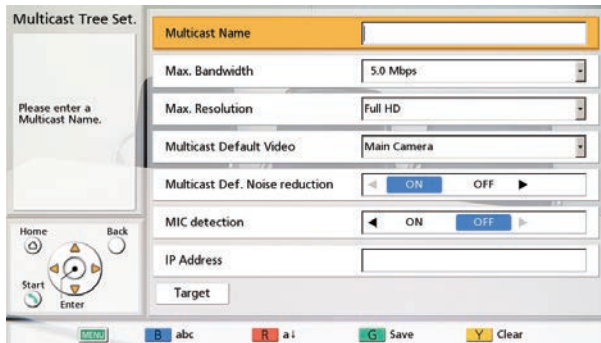

- 4. Use [▲][▼] to select the following items for input:
 - "Multicast Name"**: Enter the multicast tree name (maximum 24 characters) (Page 190).
 - "Max. Bandwidth"**: Press [ENTER] and use [▲][▼] to select the maximum bandwidth to be used for the multicast (1.0/1.2/2.0/3.0/4.0/5.0 Mbps) (default: 5.0 Mbps).

Note

- All terminals registered to the multicast tree must have twice the available bandwidth as set in **"Max. Bandwidth"**.
- In **"Call set up"**, the values for **"Max. Bandwidth"**, **"Max. Bandwidth Per Site"**, **"Max. Bandwidth Per Site (LAN 1)"**, and **"Max. Bandwidth Per Site (LAN 2)"** have no effect on the maximum bandwidth used for multicasting.

"Max. Resolution": Press [ENTER] and use [▲][▼] to select **"Full HD"** (default) or **"HD"**.

Note

- When the bandwidth of the connection used during the multicast drops, the resolution and/or frame rate of the multicast data may lower.

"Multicast Default Video": Press [ENTER] and use [▲][▼] to select the video to send when the multicast starts.

- "Main Camera"** (default): The video of the main camera is sent.
- "Sub Camera"**: The video of the sub camera is sent.
- "PC"**: The image of the PC is sent.

Note

- Performing contents sharing operations can change the video being sent during a multicast (Page 89).

"Multicast Def. Noise reduction": Use [◀][▶] to select whether noise reduction is enabled when the multicast starts.

- "ON"** (default): Noise reduction is enabled.
- "OFF"**: Noise reduction is disabled.

Note

- "Multicast Def. Noise reduction"** is not displayed for the KX-VC1000.

"MIC detection": Use [◀][▶] to select the microphone status display.

- "ON"**: Displays the microphone status.
- "OFF"** (default): Hides the microphone status.

"IP Address": Input the IP address of the multicast terminal at the top of the multicast tree.

Note

- If the value for **"IP Address"** contains 1 or 2 digit numbers, enter these numbers as they are. Do not enter values such as ".001".
Example: The IP address is [192.168.0.1].
Correct entry: [192.168.0.1]
Wrong entry: [192.168.000.001]

- Use [▲][▼] to select **"Target"** and press [ENTER].
 - The multicast target screen is displayed.

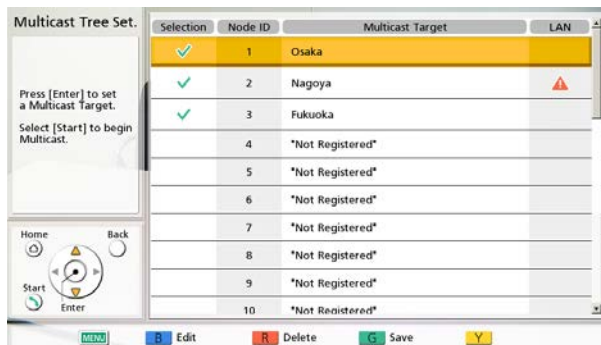

Note

- If no multicast targets with a "✓" mark displayed are registered in the selection column, the multicast will not begin when [START] is pressed.
- When **"LAN 2"** is set to **"OFF"** (Page 120), or when using a KX-VC1000/KX-VC1300, the LAN column is not displayed.
- If [▲] is displayed in a target's LAN column, multicasting will not start when you press [START]. The IP address specified for **"IP Address"** (Page 177) is an IP address of a network that the target cannot communicate with. Confirm the target's IP address.

- Use [▲][▼] to select the **"*Not Registered*"** target with the lowest node ID, and then press [B].
 - A dialogue box is displayed for selecting the input method.

When "Input Address" is selected

- The address input screen is displayed.

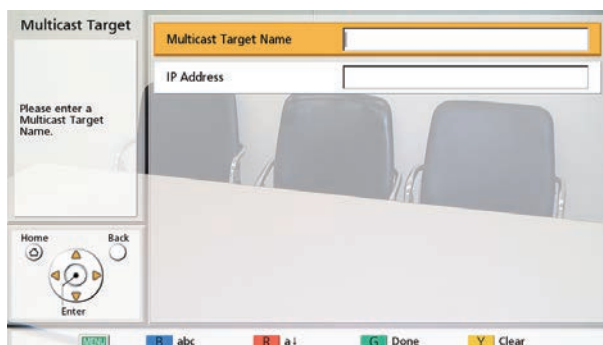

- Use [▲][▼] to select the following items for input:
 - "Multicast Target Name"**: Input the multicast target name (maximum 24 characters) (Page 190).
 - "IP Address"**: Enter the IP address.

Using Multicast

- ② Press [G].
 - The multicast target screen is displayed.

Note

- Only IPv4 addresses can be used for the multicast feature.

When "Contact list" is selected

- The contact list screen is displayed.
- ① Use [▲][▼] to select the other party to register and press [ENTER].
 - The multicast target screen is displayed.

Note

- To continue registering multicast targets, repeat the procedure from step 6.
- Register multicast targets starting from the lowest available node ID. The node ID of a **"Not Registered"** target cannot be selected for registration if it is not the lowest available number.

7. Press [G].
 - A dialogue box to confirm the saving of settings is displayed.
8. Use [◀][▶] to select "Yes" and press [ENTER].
 - The multicast tree screen is displayed.

Note

- To continue registering multicast trees, repeat steps 2–8 of the procedure.

Editing Registered Contents

1. In step 7 of "Administrator Menu List (Page 136)", select **"Multicast Tree Set."** and press [ENTER].
 - The multicast tree screen is displayed.
2. Use [▲][▼] to select the multicast tree to edit.
3. Press [B].
 - The multicast tree setting screen is displayed.

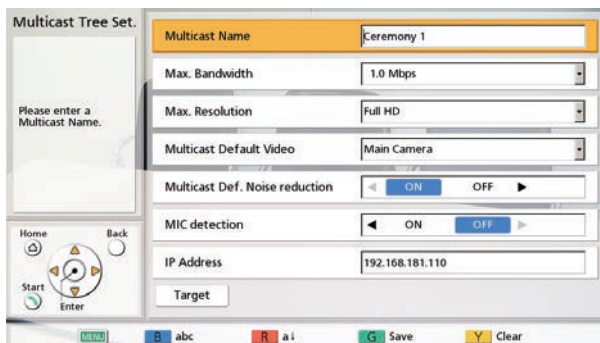

4. Use [▲][▼] to select the item to edit, and then edit it.
5. Press [G].
 - A dialogue box to confirm the saving of settings is displayed.
6. Use [◀][▶] to select "Yes" and press [ENTER].
 - The multicast tree screen is displayed.

Deleting Registered Contents

1. In step 7 of "Administrator Menu List (Page 136)", select **"Multicast Tree Set."** and press [ENTER].
 - The multicast tree screen is displayed.
2. Use [▲][▼] to select the multicast tree to delete.
3. Press [R].
 - A dialogue box to confirm the deletion is displayed.
4. Use [◀][▶] to select **"Yes"** and press [ENTER].
 - The multicast tree screen is displayed.

Starting a Multicast

Starting a Multicast

Select a multicast tree from the list of up to 10 preset multicast trees (1–10) and start the multicast.

1. In step 7 of "Administrator Menu List (Page 136)", select **"Multicast Tree Set."** and press [ENTER].
 - The multicast tree screen is displayed.
2. Use [▲][▼] to select the multicast tree to use for the multicast.
3. Press [START].
 - The multicast preparation screen is displayed, and when connection confirmations for lower-level terminals are completed, the multicast will start.

Note

- If [END] is pressed during multicast preparation, the multicast will be cancelled.
 - If no response is received from a lower-level terminal for a connection confirmation for approximately 1 minute, the multicast tree will adjust and then the multicast will start.
4. To end the multicast, press [END].

Starting a Multicast by Selecting the Multicast Target

Select a multicast target from the multicast target list registered in advance to the multicast tree, and start the multicast.

1. In step 7 of "Administrator Menu List (Page 136)", select **"Multicast Tree Set."** and press [ENTER].
 - The multicast tree screen is displayed.
2. Use [▲][▼] to select the multicast tree to use for the multicast, and press [B].
 - The multicast tree setting screen is displayed.

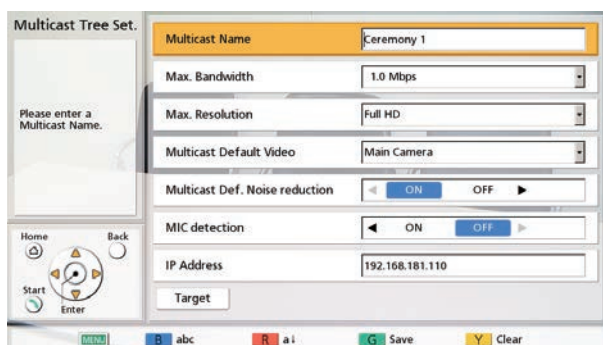

3. Use [▲][▼] to select "Target" and press [ENTER].
 - The multicast target screen is displayed.

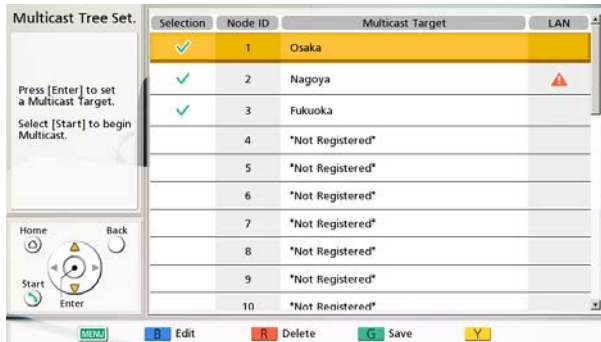

4. Use [▲][▼] to select a multicast target and press [ENTER].
 - The "✓" mark in the selection column will be added or removed. The multicast will start for the multicast targets displaying a "✓" mark.

Note

- If no multicast targets with a "✓" mark displayed are registered in the selection column, the multicast will not begin when [START] is pressed.
- If [▲] is displayed in a target's LAN column, multicasting will not start when you press [START]. The IP address specified for "IP Address" (Page 177) is an IP address of a network that the target cannot communicate with. Confirm the target's IP address.

5. Press [START].
 - The multicast preparation screen is displayed, and when connection confirmations for lower-level terminals are completed, the multicast will start.

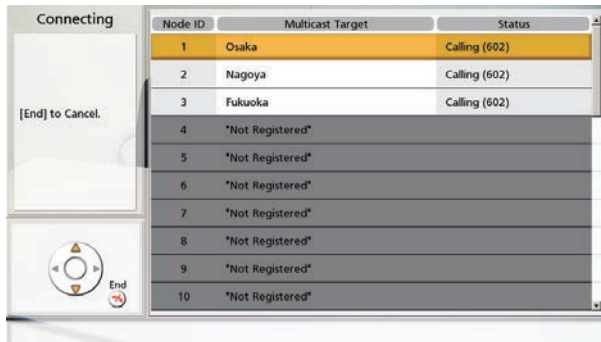

Note

- If [END] is pressed during multicast preparation, the multicast will be cancelled.
- If no response is received from a lower-level terminal for a connection confirmation for approximately 1 minute, the multicast tree will adjust and then the multicast will start.

6. To end the multicast, press [END].

Confirming the Transmission Status During a Multicast (Multicast Terminal)

- 1 Press **[STATUS]**.
 - The multicast information screen is displayed.

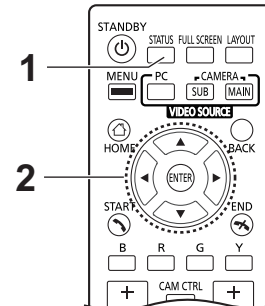
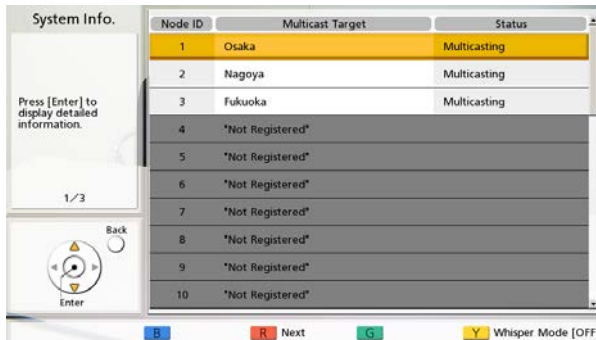

- 2 Use **[▲]**/**[▼]** to select a multicast target and press **[ENTER]**.
 - The communication status of the selected multicast target is displayed.



Note

- When **[G]** is pressed, the displayed party changes.
- When automatic adjustment for the multicast tree occurs, the adjusted node IDs are displayed in **"Current"** of **"Node ID (Set / Current)"**.

Confirming the Transmission Status During a Multicast (Relay Terminal/Receiver Terminal)

- 1 Press [STATUS].
 - The multicast information screen is displayed.

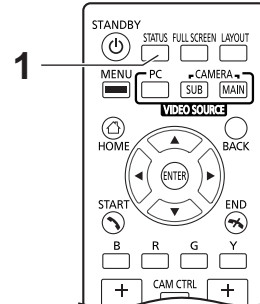

Starting and Stopping Recording During a Multicast

1. Press [MENU].
 - The multicast menu is displayed.
2. Select "USB Rec" and press [ENTER].

When not recording: A dialogue box to confirm starting recording is displayed. Use [◀|▶] to select "Yes" or "No" and press [ENTER].

 - Selecting "Yes" starts recording.
 - Selecting "No" does not start recording.

When recording: A dialogue box to confirm stopping recording is displayed. Use [◀|▶] to select "Yes" or "No" and press [ENTER].

 - Selecting "Yes" stops recording.
 - Selecting "No" does not stop recording.

Using USB Recording Features

- Record video and audio during a call, multicast, or while idle on a USB memory device connected to the back of the unit.
- You can continue recording a different transmission status. For example, you can start recording while idle, and then start and end a call while recording.
- To use USB recording features, set "**USB Rec**" to "**ON**" in "**Security Settings**" (Page 149). Also configure recording related settings in "Making Recording Settings (Page 132)".

Note

- If the multicast terminal is KX-VC300/KX-VC500/KX-VC600, you cannot record with relay and receiver terminals.

About USB Memory

- A mass storage class (FAT16 or FAT32 format) compatible USB memory device can be used with this unit.
- The following types of USB memory devices cannot be used:
 - U3 smart drives (USB memory devices compatible with the U3 platform)
 - USB memory devices with security features
 - USB memory devices formatted using NTFS
 - USB memory devices with multiple LUNs (Logical Unit Numbers)
 - USB memory devices formatted with multiple partitions

About USB Memory Devices and Recording Operations

- If a USB memory device is not connected when recording starts, a dialogue box to confirm a USB memory device connection is displayed. Press **[ENTER]**, connect a USB memory device, and start recording again. A similar dialogue box is also displayed when the USB memory device cannot be recognized. Replace it with another USB memory device and start recording again.
- If there is insufficient free space in the USB memory device when recording starts, a dialogue box notifying that recording cannot start is displayed. Press **[ENTER]**, replace the USB memory device with another one, and start recording again.
- If the amount of free space in the USB memory device becomes low while recording, a dialogue box to select whether to continue or stop recording is displayed. Use **[◀][▶]** to select "**Yes**" or "**No**" and press **[ENTER]**.
 - Selecting "**Yes**" stops recording.
 - Selecting "**No**" continues recording.
 When there is no free space, recording is stopped automatically and a dialogue box notifying recording has been stopped is displayed. Press **[ENTER]**, replace the USB memory device with another one, and start recording again.
- If the USB memory device is removed while recording, a dialogue box is displayed and recording is stopped. However, recordings up to 5 minutes before removal are not saved. Also, files may get corrupted and may not be able to play back properly. Do not remove the USB memory device while recording.
- If the AC power turns off while recording, files in the USB memory device may get corrupted and may not be able to play back properly. Do not turn off the AC power while recording.

About Recorded Data

- When recording starts, a file named "vc_DATE_TIME.mp4" is created in the root directory. Example) When recording starts on December 1, 2017, 13:30:30: vc_20171201_133030.mp4
- If the continuous recording time exceeds 4 hours (2 hours in high-quality mode), the subsequent recording is automatically saved in a new file. The name of the new file contains the date and time when the recording file was switched.
- The following are the main specifications.

Item	Specification
File format	mp4 Version 1.0
Video rate/maximum size (per file)	About 512 kbps (Video Quality: Low)/1.1 GB About 1 Mbps (Video Quality: Medium)/2.0 GB About 2 Mbps (Video Quality: High)/2.0 GB
Maximum recording time of one file	Video Quality Low/Medium: 4 hours Video Quality High: 2 hours
Necessary capacity per hour of recording	Video Quality Low: About 0.27 GB Video Quality Medium: About 0.5 GB Video Quality High: About 1 GB
Video recording format	H.264 High Profile When the unit's video frequency is 50 Hz 1280×720, 25 fps (maximum) When the unit's video frequency is 60 Hz 1280×720, 30 fps (maximum)
Audio recording format	MPEG-4 AAC-LC 64kbps monaural
Playback environment (supported media players)	Windows Media Player Ver.12 QuickTime Player Ver.10.4 (MAC)

Note

- The bitrate recorded on a USB memory device is the total of the video rate and audio rate (64 kbps).

About Recording While Idle

- Some operations and settings that can be executed while idle will not be available when recording while idle.
- The unit will not enter screen standby mode when recording while idle.
- If you turn off the unit by pressing the power button on the unit or remote control when recording while idle, recording is stopped and the unit turns off.

About Recordable Video

Video that can be recorded differs between KX-VC1000/KX-VC1300/KX-VC1600 and KX-VC2000.

KX-VC1000/KX-VC1300/KX-VC1600

- If **"Video Output"** in **"Video Output"** is set to **"HDMI 1"**
 - Single-screen display: Records the same video as HDMI1.
 - PwithP or SideBySide display: Records only the main video on the left side in full-screen display.

Note

- For PinP display, the small screen displayed inside is not recorded.
- If **"Video Output"** in **"Video Output"** is set to **"HDMI 1 / HDMI 2"**, the video set for **"Dual Display Rec screen"** in **"USB Rec Settings"** is recorded.

KX-VC2000

- If **"Video Output"** in **"Video Output"** is set to **"HDMI 1"**, the same video as HDMI1 is recorded.
- If **"Video Output"** in **"Video Output"** is set to **"HDMI 1 / HDMI 2"**, the video set for **"Dual Display Rec screen"** in **"USB Rec Settings"** is recorded.

About Recordable Audio

- While idle
Records the audio of its own site.
- During a call
 - Main site: Records the audio of the loudest four sites and its own site. If its own site is included in the loudest four sites, the audio of the four sites is recorded.
 - Sub site: Records the audio of its own site and the main site (including the audio of other sub sites combined by the main site).
- During a multicast
Records only the audio of the multicast terminal.

Using USB Device Mode

You can use a video camera or microphone connected to the HD Visual Communication Unit as a video camera or microphone for calls in general conference applications installed on a computer.

Note

- Use the activation key of the PC Peripheral (KX-VCZ501) to enable USB Device Mode. Also, refer to "Setting the USB Device Mode (Page 132)" to switch modes and configure related settings.
 - You cannot make or receive calls while in USB Device Mode^{*1}. The unit will also not enter screen standby mode.
 - You cannot connect a USB memory device to the USB jack and use it while in USB Device Mode^{*1}.
- ^{*1} USB Device Mode is when "USB Device Mode" is set to "ON" (Page 133), regardless of whether or not the unit is connected to a computer.

About Connections

Connect the computer and HD Visual Communication Unit as shown below.

Note

- Make sure to use the proprietary USB conversion cable (PGWD1933ZAJ1) included with the activation key (KX-VCZ501).

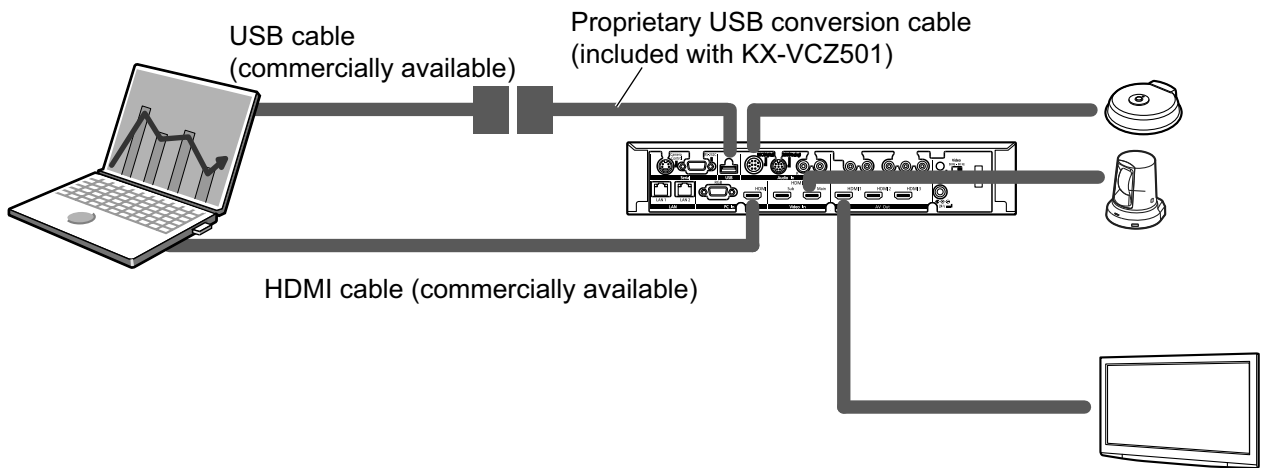

USB cable connections

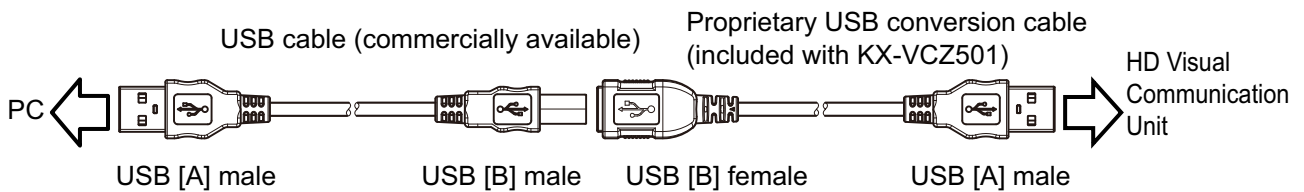

About Specifications

The following are the main specifications.

Item		Specification
Video	Standard	UVC Version 1.0
	Video format	Motion JPEG
	Resolution	When the unit's video frequency is 50 Hz 640 × 480 (maximum 25 fps) 1280 × 720 (maximum 12.5 fps) When the unit's video frequency is 60 Hz 640 × 480 (maximum 30 fps) 1280 × 720 (maximum 15 fps)
Audio	Standard	UAC Version 1.0
	Audio format	PCM/16bits/32kbps
Supported OS		Microsoft Windows 7 SP2 Microsoft Windows 8.1 operating system Microsoft Windows 10 operating system

Note

- If the computer goes into sleep, is locked, or goes into hibernate while using USB Device Mode, the video camera/microphone of the HD Visual Communication Unit may not be able to be used with the computer. In this case, perform one of the following operations.
 - Disconnect and then reconnect the USB cable
 - Set "**USB Device Mode**" to "**OFF**" and then set it again to "**ON**" (Page 133)
- If the USB cable is disconnected and the reconnected while general conference applications installed on a computer are operating, the video camera/microphone of the HD Visual Communication Unit may not be able to be used with the computer. In this case, perform one or both of the following operations.
 - Restart the general conference applications
 - Set "**USB Device Mode**" to "**OFF**" and then set it again to "**ON**" (Page 133)

Changing the Remote Control Batteries

For users in Taiwan only



廢電池請回收

1. Open the cover.

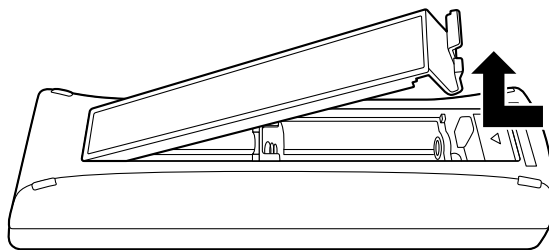

2. Take out the R6 (AA) batteries.
3. Insert new batteries (R6 [AA] dry cell), minus side first, then close the cover.

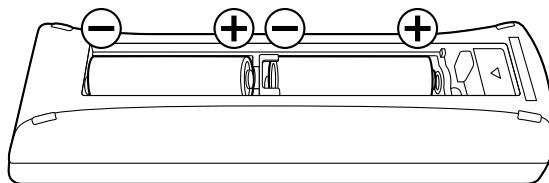

Cleaning the Unit

When cleaning the unit, make sure the power is off and all cables are unplugged. Cleaning the unit while the power is on may cause electric shock.

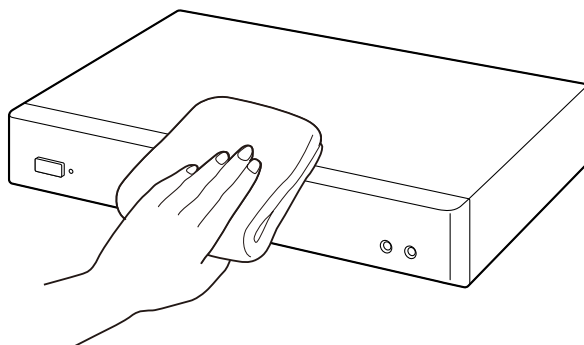

- Wipe the unit with a dry, soft cloth.
When the unit is very dirty, first clean it with a neutral, household cleaning agent using a well-wrung, damp cloth. Then, wipe down the unit with a dry, soft cloth.
- Do not use the following when cleaning the unit. They may cause unit discolouration or damage.
 - Petroleum
 - Scouring powder
 - Alcohol
 - Thinner
 - Benzine
 - Wax
 - Hot water
 - Powder soap
- If using a chemically treated cleaning cloth, be sure to follow all accompanying directions and warnings.

Inputting Letters and Numbers

You can use the remote control to input letters and numbers.

The following tables detail the characters and numbers that can be input. The language that can be input depends on which language is selected through system settings.

Press the indicated button repeatedly to cycle through the characters and numbers assigned to that button until the character you want to input is displayed. If you want to input another character using the same button, press [▶] to move the input cursor to the right.

Table 1 English/Arabic

Button	Latin Mode		Number Mode	Extended Character 1 (Western Europe) Mode		Extended Character 2 (Eastern Europe) Mode	
	Uppercase -preferred Mode	Lowercase -preferred Mode		Uppercase -preferred Mode	Lowercase -preferred Mode	Uppercase -preferred Mode	Lowercase -preferred Mode
	1	1		1	1	1	1
2 ^{ABC}	ABCabc2	abcABC2	2	AÀÁÂÃÄÅ ÆBCÇaàá âãäåæbcç 2	aáâãäåæ bcçAÀÁÄ ÅÅÆBC Ç2	AÁÂÃBCĆ Čaáâabcć AÁÂBCĆ Č2	aáâabcć AÁÂBCĆ Č2
3 ^{DEF}	DEFdef3	defDEF3	3	DEĚÉĚĚF deěéěěf3	deěéěěfD EĚÉĚĚF3	DĚÉĚĚF dĚéěěf3	dĚéěěfD ĚÉĚĚF3
4 ^{GHI}	GHIghi4	ghiGHI4	4	GĜHIiíííí İgĝhiíííí 4	gĝhiíííí GĜHIiííí 4	GHIÍghií4	ghiíGHIÍ4
5 ^{J_{KL}°}	JKLjkl5	jkIJKL5	5	JKLjkl5	jkIJKL5	JKLÍłłjkl Íł5	jkIÍłJKL Íł5
6 ^{MNO}	MNOmno6	mnoMNO6	6	MNÑOÓ ÔÕØŒ mnñoòóó õöøæ6	mnñoòóó öøæMNÑ OÓÔÕŒ ØŒ6	MNÑŃOÓ ŎŎmnňň óóö6	mnňňóóó MNÑŃOÓ ŎŎ6
7 ^{P_{QRS}}	PQRSpqr s7	pqrsPQR S7	7	PQRSSßp qrsßß7	pqrsßßP QRSßß7	PQRŘŘSS Špqrřřsss 7	pqrřřsssP QRŘŘSSŠ 7
8 ^{TUV}	TUVtuv8	tuvTUV8	8	TUÚÚŮŮ VtuúúúŮ v8	tuúúúúŮ TUÚÚŮŮ V8	TŤUÚŮŮ VtťuúúúŮ 8	tťuúúúŮ ŤUÚŮŮŮ V8
9 ^{W_{XYZ}}	WXYZwxy z9	wxyzWXY Z9	9	WŴXIJYŶ Zwŵxijyŷ Z9	wŵxijyŷ WŴXIJYŶ Z9	WXYŶYZŽ ŽŽwxyŷz žžž9	wxyŷzžž WXYŶYZŽ ŽŽ9
0 _	0 Space	0 Space	0	0 Space	0 Space	0 Space	0 Space
• @ * *	. @ : ; " = * + < >	. @ : ; " = * + < >	. @ : ; " = * + < >	. @ : ; " = * + < >	. @ : ; " = * + < >	. @ : ; " = * + < >	. @ : ; " = * + < >
#	# _ - & \$ \% ~ ^ ! ? / ` () , [] { } '	# _ - & \$ \% ~ ^ ! ? / ` () , [] { } '	# _ - & \$ \% ~ ^ ! ? / ` () , [] { } '	# _ - & \$ \% ~ ^ ! ? / ` () , [] { } '	# _ - & \$ \% ~ ^ ! ? / ` () , [] { } '	# _ - & \$ \% ~ ^ ! ? / ` () , [] { } '	# _ - & \$ \% ~ ^ ! ? / ` () , [] { } '

Table 2 Spanish

Button	Latin Mode		Number Mode	Extended Character 1 (Western Europe) Mode		Extended Character 2 (Eastern Europe) Mode	
	Uppercase -preferred Mode	Lowercase -preferred Mode		Uppercase -preferred Mode	Lowercase -preferred Mode	Uppercase -preferred Mode	Lowercase -preferred Mode
1	1	1	1	1	1	1	1
2 ^{ABC}	AÁBCaáb c2	aábcAÁB C2	2	AÁÁÁÃÃÃ ÆBCCçaaá âãääæbcç 2	aááâãääæ bcçAÁÁÃ ÃÃÃÆBC Ç2	AÁÁABCČ Čaaáabcč č2	aááabcčč AÁÁABCČ Č2
3 ^{DEF}	DEÉFdeé f3	deéfDEÉ F3	3	DEÉÉÊËF deééêëf3	deééêëfD EÉÉÊËF3	DĎEÉËËF dďeéëëf3	ďďeéëëfD ĎEÉËËF3
4 ^{GHI}	GHIÍghií4	ghiíGHIÍ4	4	GĜHIİİİİİ İgĝhiîîîîî 4	gĝhiîîîîî GĜHIİİİİİ 4	GHIÍghií4	ghiíGHIÍ4
5 ^{JKL}	JKLjkl5	jdkIJKL5	5	JKLjkl5	jdkIJKL5	JKLÍĹĹjkl ÍĹ5	jkÍĹĹJKLÍ ĹĹ5
6 ^{MNO}	MNÑOOm nñoó6	mnñoóMN ÑOO6	6	MNÑOOÓ ÔÕØØE mnñoòóò õøæ6	mnñoòóò öøæMNÑ OÕÓÔÕÖ ØE6	MNÑÑOO ÕÕmnñño óóö6	mnññoóó MNNÑOO ÕÕ6
7 ^{PQRS}	PQRSpqr s7	pqrsPQR S7	7	PQRSŞßp qrsşß7	pqrsşßP QRSŞß7	PQRŘŘSŠ Špqrřřsš 7	pqrřřsšP QRŘŘSŠ 7
8 ^{TUV}	TUÚÜVtu úüv8	tuúüvTUÚ ÜV8	8	TUÚÚÜÜÜ Vtuúúüü v8	tuúúüüü TUÚÚÜÜÜ V8	TŤUÚÜÜÜ Vtťuúüüü 8	tťuúüüü ŤUÚÜÜÜ 8
9 ^{WXYZ}	WXYZwxy z9	wxyzWXY Z9	9	WŴXIJYŶ Zwŵxijyŷ Z9	wŵxijyŷ WŴXIJYŶ Z9	WXYŶŶZ ŽŽwxyŷ žžž9	wxyŷŷžž WXYZŶŶ ŽŽ9
0 _	0 Space	0 Space	0	0 Space	0 Space	0 Space	0 Space
• [@] *	.@:; "=*+ <>	.@:; "=*+ <>	.@:; "=*+ <>	.@:; "=*+ <>	.@:; "=*+ <>	.@:; "=*+ <>	.@:; "=*+ <>
#	#_ - & \$ \% ~^! ? / ^ () , [] { } '	#_ - & \$ \% ~^! ? / ^ () , [] { } '	#_ - & \$ \% ~^! ? / ^ () , [] { } '	#_ - & \$ \% ~^! ? / ^ () , [] { } '	#_ - & \$ \% ~^! ? / ^ () , [] { } '	#_ - & \$ \% ~^! ? / ^ () , [] { } '	#_ - & \$ \% ~^! ? / ^ () , [] { } '

Table 3 Portuguese

Button	Latin Mode		Number Mode	Extended Character 1 (Western Europe) Mode		Extended Character 2 (Eastern Europe) Mode	
	Uppercase -preferred Mode	Lowercase -preferred Mode		Uppercase -preferred Mode	Lowercase -preferred Mode	Uppercase -preferred Mode	Lowercase -preferred Mode
1	1	1	1	1	1	1	1
2 ^{ABC}	AÁÃÄÅABC Çaáãääàbc ç2	aáãääàbcç AÁÃÄÅABC Ç2	2	AÁÃÄÅÃÄ ÆBCÇaáá ãääääæbcç 2	aáãääääæ bcçAÁÃÄ ÃÄÆBC Ç2	AÁÃÄBCĆ Čaáãabcć č2	aáãabcćč AÁÃÄBCĆ Č2
3 ^{DEF}	DEÉÊFde éêf3	deéêfDEÉ ÊF3	3	DEÉÊÊF deééêf3	deèèèèfD EÊÊÊÊF3	DĎEĚĚĚF dďeěěěf3	dďeěěěfD ĎEĚĚĚF3
4 ^{GHI}	GHIÍghii4	ghiiGHIÍ4	4	GĜHIÍÍÍÍ İgĝhiíííí 4	gĝhiíííí GĜHIÍÍÍÍ 4	GHIÍghii4	ghiiGHIÍ4
5 ^{J_{KL}°}	JKLjkl5	jkIJKL5	5	JKLjkl5	jkIJKL5	JKLĹĽĹjkl ĺł5	jkIĹĹJKLĹ ĺł5
6 ^{MNO}	MNOÓÔÕ mnoóôõ6	mnoóôõM NOÓÔÕ6	6	MNÑOÓ ÔÕØŒ mnñoòó õøœ6	mnñoòóôõ øœMNÑ OÓÔÕÖ ØŒ6	MNÑŃOÓ ŎŎmnňño óõö6	mnňñoóóõ MNÑŃOÓ ŎŎ6
7 ^{P_{QRS}}	PQRSpqr s7	pqrsPQR S7	7	PQRSŞßp qrsşß7	pqrsşßP QRSŞß7	PQRŔŖŠŚ Şpqrŕŕšš 7	pqrŕŕššP QRŔŖŠŚ 7
8 ^{TUV}	TUÚÛVtuú üv8	tuúüvTUÚ ÜV8	8	TUÛÜŮŮŮ Vtuúúüü v8	tuúúüüŮ TUÛÜŮŮ V8	TŤUŮŮŮŮ VtŕuúüüŮ 8	tŕuúüüŮ ŤUŮŮŮŮ V8
9 ^{W_{XYZ}}	WXYZwxy z9	wxyzWXY Z9	9	WŴXIJYŶ Zwŵxijyŷ Z9	wŵxijyŷ WŴXIJYŶ Z9	WXYŶŶZŹ ŽŽwxyŷŷ źźź9	wxyŷŷźź WXYŶŶZŹ ŽŽ9
0 _	0 Space	0 Space	0	0 Space	0 Space	0 Space	0 Space
• @ *	.@:;="*+ <>	.@:;="*+ <>	.@:;="*+ <>	.@:;="*+ <>	.@:;="*+ <>	.@:;="*+ <>	.@:;="*+ <>
#	#_&\$\% ~^!~/^(), []{}'	#_&\$\% ~^!~/^(), []{}'	#_&\$\% ~^!~/^(), []{}'	#_&\$\% ~^!~/^(), []{}'	#_&\$\% ~^!~/^(), []{}'	#_&\$\% ~^!~/^(), []{}'	#_&\$\% ~^!~/^(), []{}'

Table 4 Japanese

Button	Katakana Mode (Full-Width)	Latin Mode (Normal)		Number Mode (Normal)
		Uppercase -preferred Mode	Lowercase -preferred Mode	
1	アイウエオアイウエオ	1	1	1
2 ^{ABC}	カキクケコ	ABCabc2	abcABC2	2
3 ^{DEF}	サシスセソ	DEFdef 3	defDEF3	3
4 ^{GHI}	タチツテトツ	GHIghi4	ghiGHI4	4
5 ^{J_{KL}°}	ナニヌネノ	JKLjkl5	jklIJKL5	5
6 ^{MNO}	ハヒフヘホ	MNOmno6	mnoMNO6	6
7 ^{P_{QRS}}	マミムメモ	PQRSpqrs7	pqrsPQRS7	7
8 ^{TUV}	ヤユヨヤユヨ	TUVtuv8	tuvTUV8	8
9 ^{W_{XYZ}}	ラリルレロ	WXYZwxyz9	wxyzWXYZ9	9
0 _	ワヲンワー (Full-width space)	0 (Normal space)	0 (Normal space)	0
• [@] *	° (Voicing mark) ° (Half-voicing mark)	. @ ; ; " = * + < >	. @ ; ; " = * + < >	. @ ; ; " = * + < >
#	. @ : ; " = * + < > # _ - & \$ ¥ % ~ ^ ! ? / ` () , [] { } ' [] { } '	# _ - & \$ \ % ~ ^ ! ? / ` () , [] { } '	# _ - & \$ \ % ~ ^ ! ? / ` () , [] { } '	# _ - & \$ \ % ~ ^ ! ? / ` () , [] { } '

Table 5 Russian

Button	Cyrillic Mode		Number Mode	Latin Mode	
	Uppercase -preferred Mode	Lowercase -preferred Mode		Uppercase -preferred Mode	Lowercase -preferred Mode
1	1	1	1	1	1
2 ^{ABC}	АБВГабвг2	абвгАБВГ2	2	АÁÂÃÀBCÇ аáâãàbcç2	АÁÂÃÀBCÇ2 аáâãàbcç2
3 ^{DEF}	ДЕЁЖЗдеёж з3	деёжзДЕЁЖ 33	3	DEÉÊFdeéê f3	deéêfDEÉÊ F3
4 ^{GHI}	ИЙКЛиикл4	ийклИЙКЛ4	4	GHIÍghií4	ghiíGHIÍ4
5 ^{J_{KL}°}	МНОПмноп5	мнопМНОП5	5	JKLjkl5	jklJKL5
6 ^{MNO}	РСТУрсту6	рстуРСТУ6	6	MNOÓÔÕm ноóóõ6	mnoóóõM NOÓÔÕ6
7 ^{P_{QRS}}	ФХЦЧфхцч7	фхцчФХЦЧ7	7	PQRSpqrs7	pqrsPQRS7
8 ^{TUV}	ШЩЪЫшщъ ы8	шщъыШЩЪ Ы8	8	TUÚÜVtuúü v8	tuúüvTUÚÜ V8
9 ^{W_{XYZ}}	ЪЭЮЯъэюя9	ъэюяЪЭЮЯ9	9	WXYZwxyz z9	wxyzWXYZ Z9
0 ⁻	0 Space ГЄІЎ гєіў	0 Space гєіў ГЄІЎ	0	0 Space	0 Space
• ^{@ *}	.@:; "=*+ <>	.@:; "=*+ <>	.@:; "=*+ <>	.@:; "=*+ <>	.@:; "=*+ <>
#	#_ -&\$\% ~^!?!/`(), []{}'	#_ -&\$\% ~^!?!/`(), []{}'	#_ -&\$\% ~^!?!/`(), []{}'	#_ -&\$\% ~^!?!/`(), []{}'	#_ -&\$\% ~^!?!/`(), []{}'

Continued on next page

Table 6 Chinese

Button	Latin Mode		Number Mode
	Uppercase-preferred Mode	Lowercase-preferred Mode	
1	1	1	1
2^{ABC}	ABCabc2	abcABC2	2
3^{DEF}	DEFdef3	defDEF3	3
4^{GHI}	GHIghi4	ghiGHI4	4
5^{JKL°}	JKLjkl5	jklJKL5	5
6^{MNO}	MNOmno6	mnoMNO6	6
7^{PQRS}	PQRSpqrs7	pqrsPQRS7	7
8^{TUV}	TUVtuv8	tuvTUV8	8
9^{WXYZ}	WXYZwxyz9	wxyzWXYZ9	9
0₋	0 (Normal space)	0 (Normal space)	0
•[@]/_*	.@:;”=*<>	.@:;”=*<>	.@:;”=*<>
#	#_ -&\$%\~^!?’/‘(),[]{ }’	#_ -&\$%\~^!?’/‘(),[]{ }’	#_ -&\$%\~^!?’/‘(),[]{ }’

Table 7 German

Button	Latin Mode		Number Mode	Extended Character 1 (Western Europe) Mode		Extended Character 2 (Eastern Europe) Mode	
	Uppercase -preferred Mode	Lowercase -preferred Mode		Uppercase -preferred Mode	Lowercase -preferred Mode	Uppercase -preferred Mode	Lowercase -preferred Mode
1	1	1	1	1	1	1	1
2 ^{ABC}	AÄBCaäb c2	aäbcAÄB C2	2	ÄÄÄÄÄÄÄ ÆBCÇaää âääääæbcç 2	aääääääæ bcçÄÄÄÄ ÄÄÄÆBC Ç2	ÄÄÄABCČ Čaääabcč č2	aääabcčč ÄÄÄABCČ Č2
3 ^{DEF}	DEFdef 3	defDEF3	3	DEÉÊËËËF deëëëëëf3	deëëëëëfD EÉÊËËËF3	DĐEÉËËËF dđeéëëëf3	dđeéëëëfD ĐEÉËËËF3
4 ^{GHI}	GHIghi4	ghiGHI4	4	GǞHIİİİİİİ İǧǧhiİİİİİİ 4	ǧǧhiİİİİİİ GǞHIİİİİİİ 4	GHIİghiİ4	ghiİGHIİ4
5 ^{J_{KL}°}	JKLjkl5	jkIJKL5	5	JKLjkl5	jkIJKL5	JKLÍÍÍÍÍÍÍÍ ÍÍ5	jkIÍÍÍÍÍÍÍ ÍÍ5
6 ^{MNO}	MNOÖmn oö6	mnoöMNO Ö6	6	MNÑOOÓ ÔÖØØØ mnñooóóó öøæMNÑ OOÓÔÖÖ öøøæ6	mnñooóóó öøæMNÑ OOÓÔÖÖ ØØæ6	MNÑÑOOÓ ÖÖmnñño óóö6	mnññoóóó MNÑÑOOÓ ÖÖ6
7 ^{P_{QRS}}	PQRSßpq rsß7	pqrsßPQR Sß7	7	PQRSßßp qrsßß7	pqrsßßP QRSßß7	PQRŘŘSŠ Špqřřsšš 7	pqrřřsššP QRŘŘSŠŠ 7
8 ^{TUV}	TUÜVtuüv 8	tuüvTUÜV 8	8	TUÜÚÚÜÜÜ Vtuüúúüü v8	tuüúúüüü TUÜÚÚÜÜÜ V8	TŤUÚÚÚŤ VtŤuúúüü 8	tŤuúúúŤ ŤUÚÚÚŤ 8
9 ^{W_{XYZ}}	WXYZwxy z9	wxyzWXY Z9	9	WŴXIJYÿ Zwŵxijyÿz 9	wŵxijyÿz WŴXIJYÿ Z9	WXYÿÿZŽ ŽŽwxyÿÿz žžž9	wxyÿÿzžž WXYZÿÿZŽ ŽŽ9
0 _	0 Space	0 Space	0	0 Space	0 Space	0 Space	0 Space
. @ * *	. @ : ; " = * + < >	. @ : ; " = * + < >	. @ : ; " = * + < >	. @ : ; " = * + < >	. @ : ; " = * + < >	. @ : ; " = * + < >	. @ : ; " = * + < >
#	# _ - & \$ \% ~ ^ ! ? / ' () , [] { } '	# _ - & \$ \% ~ ^ ! ? / ' () , [] { } '	# _ - & \$ \% ~ ^ ! ? / ' () , [] { } '	# _ - & \$ \% ~ ^ ! ? / ' () , [] { } '	# _ - & \$ \% ~ ^ ! ? / ' () , [] { } '	# _ - & \$ \% ~ ^ ! ? / ' () , [] { } '	# _ - & \$ \% ~ ^ ! ? / ' () , [] { } '

Table 9 Italian

Button	Latin Mode		Number Mode	Extended Character 1 (Western Europe) Mode		Extended Character 2 (Eastern Europe) Mode	
	Uppercase -preferred Mode	Lowercase -preferred Mode		Uppercase -preferred Mode	Lowercase -preferred Mode	Uppercase -preferred Mode	Lowercase -preferred Mode
1	1	1	1	1	1	1	1
2 ^{ABC}	AÀBCaàb c2	aàbcAÀB C2	2	AÀÁÃÄÅ ÆBCÇaàá âãäåæbcç 2	aàáâãäåæ bcçAÀÁÄ ÅÄÆBC Ç2	AÀÁABCÇ Čaáäåbcć č2	aáäåbcćč AÀÁABCÇ Č2
3 ^{DEF}	DEÈÉFde èéf 3	deèéfDEÈ ÉF3	3	DEÈÉÊËF deèèèëf3	deèèèëfD EÈÉÊËF3	DĎEĚĚF dďeěěf3	dďeěěfD ĎEĚĚF3
4 ^{GHI}	GHIìghii4	ghiiGHIì4	4	GĜHIìíííí Ígĝhiiíííí 4	gĝhiiííííí GĜHIÍÍÍÍÍ 4	GHIÍghií4	ghiiGHIÍ4
5 ^{JKL°}	JKLjkl5	jkIJKL5	5	JKLjkl5	jkIJKL5	JKLÍĹĹjkl ÍĹ5	jkIÍĹĹJKLÍ ĹĹ5
6 ^{MNO}	MNOÒÓm noóó6	mnoóóMN OÓÓ6	6	MNÑOOÓ ÔÕÖØŒ mnñoóóó õöøæ6	mnñoóóó öøæMNÑ OÓÓÓŒ ØŒ6	MNÑŃOÓ ŎŎmnňň óóó6	mnňňoóóó MNÑŃOÓ ŎŎ6
7 ^{PQRS}	PQRSpqr s7	pqrsPQR S7	7	PQRSSßp qrssß7	pqrsßßP QRSSß7	PQRŔŖSS Špqrŕŕssš 7	pqrŕŕssšP QRŔŖSSŠ 7
8 ^{TUV}	TUÛVtuùv 8	tuùvTUÛV 8	8	TUÛÚÛÜŮ VtuúúúüŮ v8	tuúúúüŮ TUÛÚÛÜŮ V8	TŤUÛÜŮŮ VtŕuúúüŮ 8	tŕuúúüŮT ŤUÛÜŮŮV 8
9 ^{WXYZ}	WXYZwxy z9	wxyzWXY Z9	9	WŴXIJYŶ Zwŵxijyŷ Z9	wŵxijyŷ WŴXIJYŶ Z9	WXYŸYZZ ŽŽwxyŷz žžž9	wxyŷŷzzž WXYZŸYZŽ ŽŽ9
0 _	0 Space	0 Space	0	0 Space	0 Space	0 Space	0 Space
• [@] [*]	.@:;="*+ <>	.@:;="*+ <>	.@:;="*+ <>	.@:;="*+ <>	.@:;="*+ <>	.@:;="*+ <>	.@:;="*+ <>
#	#_&\$\% ~^!?/\`(), []{}'	#_&\$\% ~^!?/\`(), []{}'	#_&\$\% ~^!?/\`(), []{}'	#_&\$\% ~^!?/\`(), []{}'	#_&\$\% ~^!?/\`(), []{}'	#_&\$\% ~^!?/\`(), []{}'	#_&\$\% ~^!?/\`(), []{}'

Table 10 Dutch

Button	Latin Mode		Number Mode	Extended Character 1 (Western Europe) Mode		Extended Character 2 (Eastern Europe) Mode	
	Uppercase -preferred Mode	Lowercase -preferred Mode		Uppercase -preferred Mode	Lowercase -preferred Mode	Uppercase -preferred Mode	Lowercase -preferred Mode
1	1	1	1	1	1	1	1
2^{ABC}	AÁÄBCaá äbc2	aääbcAÄÄ BC2	2	AÄÄÄÄÄÄÄ ÆBCÇaää ääääæbcç 2	aääääääæ bcçAÄÄÄ ÄÄÄÆBC Ç2	AÄÄÄBCĆ Čaääabcć č2	aäääbcćć AÄÄÄBCĆ Č2
3^{DEF}	DEËÉËËF eèéëf3	deèéëfDE ÉÉÉF3	3	DEËÉËËF deèéëëf3	deèéëëfD EËËËËF3	DËEËËËF dèeéëëf3	dd'eéëëfD ËEËËËF3
4^{GHI}	GHIÍíghií 4	ghiííGHIÍí 4	4	GĜHIÍÍÍÍÍ İgĝhiííííí 4	gĝhiííííí GĜHIÍÍÍÍÍ 4	GHIÍíghií4	ghiíGHIÍ4
5^{J_{KL}°}	JKLjkl5	jkIJKL5	5	JKLjkl5	jkIJKL5	JKLÍíłłjkl Ííł5	jkIÍíłł Ííł5
6^{MNO}	MNOÓÖm noöó6	mnoóöMN OÓÖ6	6	MNÑOÓ ÔÖØ mnñoóó öøøæ6	mñnoóóó öøæMNÑ OÓÖÔÖ ØÖ6	MNÑŃO ŃŃmnñño óóó6	mññoóóó MNÑŃO ŃŃ6
7^{P_{QRS}}	PQRSpqr s7	pqrsPQR S7	7	PQRSŞßp qrsşß7	pqrsşßP QRSŞß7	PQRŔŖŠŚ Şpqrŕŕšš 7	pqrŕŕšššP QRŔŖŠŚ 7
8^{TUV}	TUÚÜVtuú üv8	tuúüvTUÚ ÜV8	8	TUÛÜÛÛÛ Vtuúúüü v8	tuúúüüü TUÛÜÛÛÛ V8	TŤUÛÛÛÛ VtŤuúüüü 8	ttuúüüüvT ŤUÛÛÛÛV 8
9^{W_{XYZ}}	WXIJYZw xijyz9	wxijyzWX IJYZ9	9	WŴXIJYŶ Zwŵxijyŷ Z9	wŵxijyŷ WŴXIJYŶ Z9	WXYŶŶZŹ ŽŽwxyŷŷ žžž9	wxyŷŷžžž WXYŶŶZŹ ŽŽ9
0 _	0 Space	0 Space	0	0 Space	0 Space	0 Space	0 Space
• @ *	. @ : ; " = * + < >	. @ : ; " = * + < >	. @ : ; " = * + < >	. @ : ; " = * + < >	. @ : ; " = * + < >	. @ : ; " = * + < >	. @ : ; " = * + < >
#	# _ - & \$ \% ~ ^ ! ? / ` () , [] { } '	# _ - & \$ \% ~ ^ ! ? / ` () , [] { } '	# _ - & \$ \% ~ ^ ! ? / ` () , [] { } '	# _ - & \$ \% ~ ^ ! ? / ` () , [] { } '	# _ - & \$ \% ~ ^ ! ? / ` () , [] { } '	# _ - & \$ \% ~ ^ ! ? / ` () , [] { } '	# _ - & \$ \% ~ ^ ! ? / ` () , [] { } '

Switching the Input Mode

Each time **[B]** or **[R]** is pressed, the input mode will be switched in the following cycle:

- **[B] (When Japanese is selected for the display language):** Katakana Mode → Latin mode → number mode
[B] (When a language other than Japanese, Chinese, or Russian is selected for the display language): Latin mode → number mode → extended character 1 mode → extended character 2 mode
- **[B] (When Chinese is selected for the display language):** Latin mode → number mode
- **[B] (When Russian is selected for the display language):** Cyrillic mode → number mode → Latin mode → extended character 1 mode → extended character 2 mode
- **[R] (When an input mode other than Katakana mode or number mode is selected):** lowercase-preferred mode → uppercase-preferred mode

The current input mode is displayed in the guide area.

Example: Latin mode and lowercase-preferred mode currently selected

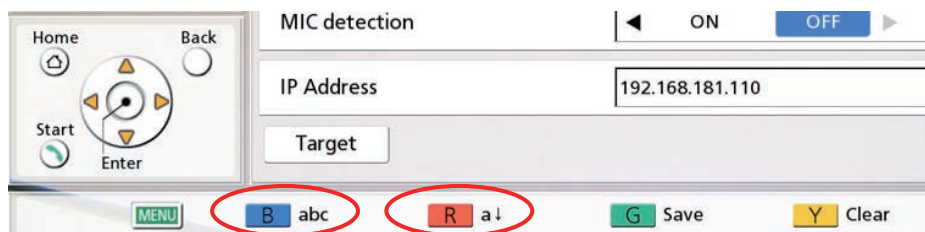

Deleting an Input Character

Press **[Y]** to delete an input character. The character deleted depends on the position of the cursor:

- If the cursor is to the right of the last character in the line, the last character will be deleted.
- If the cursor is within a line of characters, the character to the right of the cursor will be deleted.

Inserting Characters

Use **[◀]****[▶]** to move the cursor to the position where you want to insert characters, and then begin input. The characters will be inserted at the location of the cursor.

Troubleshooting

If a problem is occurring with the operation of the device, check here for possible solutions. Before proceeding check all connections to make sure they are secure, and that power is flowing from the outlet that the unit is plugged into.

Basic Operation

Problem	Cause and Solution
The power does not turn on.	<ul style="list-style-type: none"> • The power cord is not plugged into the outlet. → Plug the power cord into the outlet.
There is no display.	<ul style="list-style-type: none"> • A cable or cord is not properly connected. → Check that all cables to the unit are connected properly (Page 23). Perform self diagnosis, and check the performance of the video camera and the display that are connected to the unit (Page 134). • The main video camera is not turned on. → Turn on the main video camera. • The display is not turned on, or the input that the unit is connected to is not selected. → Turn on the display, and select the input that the unit is connected to. • The unit is in screen standby mode. → Pushing a button on the remote control, or receiving a video conference call will end standby mode and the display will return. <p>Note</p> <ul style="list-style-type: none"> • The network administrator can set the length of time until the unit enters screen standby mode (Page 127). • When connecting a device equipped with HDCP (High-bandwidth Digital Content Protection), only a blue or blue/black screen may be displayed. → If an image is not correctly displayed, do not connect an HDCP-equipped device.
The area at the edges of the screen is not displaying properly.	<ul style="list-style-type: none"> • The display is not set to show the full image. → Set the display to show images at full screen. • When connecting to an MCU or non-Panasonic video conference system, the other party's image may be trimmed, depending on the device used by the other party. → Contact your dealer.
The aspect ratio of the image is not correct.	<ul style="list-style-type: none"> • When connecting to an MCU or non-Panasonic video conference system, the aspect ratio of the image displayed on the other party's device may not be displayed correctly, depending on the device used. → During a 2-party video conference call, pressing [G] will display the dialogue box for changing the aspect ratio. Press [▲][▼] to select an aspect ratio. The dialogue box will disappear after approximately 3 seconds. The changed aspect ratio will return to "Auto" (default) when the call is ended.

Problem	Cause and Solution
<p>Operation is unresponsive or incorrect.</p>	<ul style="list-style-type: none"> • Cables or cords may not be connected properly. → Check that all cables to the unit are connected properly (Page 23). • An error has occurred. → Turn off the unit and restart it. • There may be a problem with your communication lines. → Contact your dealer.
<p>The remote control is unresponsive.</p>	<ul style="list-style-type: none"> • The batteries are depleted. → Replace with new batteries. • The remote control is being used out of the signal reception range. → Make sure to use the remote control within the signal reception range. • The remote control ID differs between the unit and the remote control. • If the batteries in the remote control run out (or if they are taken out of the remote control), and more than 1 day passes, the remote control's ID will be initialised. → Change the settings so that the remote control ID of the unit and the remote control match. Perform the following procedure: <ol style="list-style-type: none"> 1. Turn off the unit and restart it. <ul style="list-style-type: none"> • The Home screen is displayed. Check the remote control ID of the unit (Page 41). <p>Note</p> <ul style="list-style-type: none"> • If the remote control ID is not displayed on the Home screen, contact your dealer. <ol style="list-style-type: none"> 2. Press and hold [·] and [#] at the same time. 3. Within 2 seconds after you release the buttons, press the number (1 to 3) corresponding to the ID displayed on the Home screen. <p>Note</p> <ul style="list-style-type: none"> • If the remote control is still unresponsive after performing the procedure above, contact your dealer. • Cameras that support the remote control through function are set to receive signals from a remote control. → When using the remote control, be sure to point it at the remote control signal receiver of the camera. → If you need to send the remote control signals to the unit, set "Remote control through function" ("FIX Cam's Remote Ctrl Rcvr" for software versions lower than 4.50) to "OFF" (Page 131). • The unit is set to receive signals from a remote control. → When using the remote control, be sure to point it at the remote control signal receiver of the unit (Page 22). → If you need to send the remote control signals to the camera, set "Remote control through function" ("FIX Cam's Remote Ctrl Rcvr" for software versions lower than 4.50) to "ON" (Page 131).

Problem	Cause and Solution
<p>You cannot control your own video camera (main or sub video camera) with the remote control.</p>	<ul style="list-style-type: none"> • Your video camera is not a video camera supported by this unit. → Use a video camera that is supported by this unit. For details, contact your dealer. • You are trying to use a function that is not supported by your video camera. For example, you tried to use the pan function with a video camera that supports only the zoom function. → Check whether your video camera supports the function you are trying to use. • When you connect both the main video camera and sub video camera to your unit, you may become unable to control one or both of the video cameras. → Disconnect the HDMI cable of the video camera you cannot control, and then connect that video camera's HDMI cable again.
<p>You cannot control the other party's video camera (main or sub video camera) with the remote control.</p>	<ul style="list-style-type: none"> • The other party's video camera is not a video camera supported by this unit. → Ask the other party to use a video camera that is supported by this unit. For details, have the other party contact the dealer. • "CAM ctrl from remote site(s)" is set to "OFF" on the other party's unit (Page 131). → Ask the other party to set "CAM ctrl from remote site(s)" to "ON" on their unit. • You are trying to use a function that is not supported by the other party's video camera. For example, you tried to use the pan function with a video camera that supports only the zoom function. → Check whether the other party's video camera supports the function you are trying to use. • When the other party connects both the main video camera and sub video camera to their unit, you may become unable to control one or both of their video cameras. → Ask the other party to disconnect the HDMI cable of the video camera you cannot control, and then connect that video camera's HDMI cable again. • One of the parties is using a unit with an incompatible software version. → Check the software version of all parties. Update the unit so that the versions match. • The other party is using a non-Panasonic video conference system. → If the other party uses a non-Panasonic video conference system, some operations may not be possible or some operations may not function as expected. • Your own site is a Sub Site in a multiple-party video conference call using a built-in MCU, and so you are not permitted to control the other party's video camera. → Set "Camera control transmitting" of "MCU Settings" to "ON".

Problem	Cause and Solution
<p>Cannot connect with another party.</p>	<ul style="list-style-type: none"> • The LAN cable for LAN1 or LAN2 (KX-VC1600/KX-VC2000) is not connected properly. → Check that it is connected to the unit properly (Page 23). Perform a network test by entering the IP address of the other party, and then confirm the connection to the other party (Page 134). • The routing information is incorrect. → Confirm your network and routing settings, and then contact your administrator. • The maximum bandwidth setting is incorrect. → If you are trying to connect to a non-Panasonic video conference system, a connection might not be possible depending on either your or the other party's bandwidth settings. Either check your settings and change them, or have the other party do the same (Page 122). • The call type setting is incorrect. → Set the call type setting so that it is the same as the other party's (Page 143). • The SIP settings are incorrect. → Check the SIP settings (Page 144). After you check the SIP settings, if you still cannot connect to the other party, contact your network administrator. • The ID and password for digest authentication are incorrect. → Check that the values specified for "Authentication ID" and "Authentication Password" are correct (Page 144). • The "SIP Transport Protocol" setting is different from the other party's. → Set the "SIP Transport Protocol" setting so that it is the same as the other party's (Page 144). • The local site selection is incorrect. → Confirm the local site. Select the local site that is appropriate for your usage environment (Page 113). • The IP address is not entered correctly. → Confirm that the other party's IP address is correctly entered. • The SIP URI (or SIP user name), H.323 extension, or H.323 name is not entered correctly. → Check whether the SIP URI (or SIP user name), H.323 extension, or H.323 name of the other party is entered correctly or whether it conforms to the relevant standard. • The MCU's conference room number@IP address is not entered correctly. → Check whether the conference room number and IP address of the MCU is entered correctly.

Problem	Cause and Solution
	<ul style="list-style-type: none"> • When making a video conference call by entering an MCU's conference room number@IP address, "SIP Server" or "Gatekeeper" is set to "ON". → Change the "SIP Server" and "Gatekeeper" settings to "OFF" (Page 144, Page 145). • The Internet connection is not established. → Some hubs, routers, etc. can take 10 seconds or more to establish an Internet connection. • There may be a problem with your communication lines. → Contact your dealer. • You are trying to make a video conference call by connecting to an MCU or non-Panasonic video conference system. → When connecting to an MCU or non-Panasonic video conference system, encryption may not be available or some operations may not function as expected, depending on the device used by the other party. In this case, contact your dealer. • You are trying to connect to an MCU or non-Panasonic video conference system that is not compatible. → Use the outgoing call history to confirm the name of the device, and then contact your dealer. • The host name is not being resolved to the correct IP address. → Check the settings for "DNS Server" or "Primary DNS Server" in network settings (Page 118). • The IP address set for LAN1 and IP address set for LAN2 may be using the same network address (KX-VC1600/KX-VC2000). → Check the IP addresses set for LAN1 and LAN2 in the Unit Information on the Home screen (Page 41). If the addresses are using the same network address, contact your network administrator. • When "Auto (SLAAC)" is selected for "IPv6 Address (LAN 1)" (setting), the IP address and default gateway will not be set. → The router is not connected. → The router is not correctly configured. Contact your network administrator. (Set the prefix length distributed by the router to be 64. When the prefix length is set to a value other than 64, IPv6 addresses cannot be registered.) • When "Auto (DHCP)" is selected for "IPv6 Address (LAN 1)" (setting), the IP address and default gateway will not be set. → The DHCPv6 server or router is not connected. → The DHCPv6 server is not correctly configured. Contact your network administrator. (Set the address to be distributed by the DHCPv6 to be the global address. When the distributed address is not the global address, IPv6 addresses cannot be registered.)

Problem	Cause and Solution
<p>The image is distorted.</p>	<ul style="list-style-type: none"> • The settings of the hub or router are different to those of the unit. → Contact your dealer. • Packet loss is occurring. (The network is congested.) → Check the display of the network status indication (Page 45). If the icon shows only 0–1 bars continuously, press [STATUS] twice and check the fields "Loss" and "Bandwidth", then contact your network administrator or dealer (Page 104). • The maximum bandwidth setting is incorrect. → For multiple-party video conference calls, each site requires at least 256 kbps of bandwidth. For "Max. Bandwidth", set a value equal to or greater than (256 kbps × the number of site connections) (Page 122). → If you are trying to connect to an MCU or non-Panasonic video conference system, depending on the other party's device, the image may be distorted due to lack of bandwidth. In this case, contact your dealer. • There may be a problem with your communication lines. → Contact your dealer.
<p>The maximum bandwidth changes during a video conference call.</p>	<ul style="list-style-type: none"> • The maximum bandwidth during a video conference call adjusts to that of the party that has set the lowest bandwidth for the maximum bandwidth setting among all participating parties. → If there is a problem with your communication lines, contact your dealer.
<p>The computer or sub video camera's video is not displayed.</p>	<ul style="list-style-type: none"> • Cables or cords may not be connected properly. → Make sure all connections to the unit are correct (Page 89). On the Home screen, press [PC] or [CAMERA SUB] and then check the computer's screen or sub video camera's image. • The computer's display resolution is incompatible with the unit. → Set your computer's resolution to a setting compatible with the unit (Page 89).

Audio

Problem	Cause and Solution
The other party cannot hear your voice.	<ul style="list-style-type: none"> • The microphone cable is not properly connected. → Check that the microphone is properly connected to the unit (Page 23). Perform self diagnosis, and check the performance of the microphones that are connected to the unit (Page 134). • The microphone is muted. → Press [MIC MUTE] on the remote control, or press the MIC Mute button on the Boundary Microphone to unmute the microphone (Page 86). • "Default MIC Mute set (Make Call)" is set to "ON". • "Default MIC Mute set (Incoming)" is set to "ON". → The microphone is muted at the time when communication starts. Confirm the settings (Page 122). • The microphone is being obstructed. → During the video conference call, do not block the microphone with your hand or other object. • You are too far from a microphone. → Speak close to a microphone. • More than 5 Digital Boundary Microphones are connected in cascade. → Connect no more than 4 Digital Boundary Microphones at a time. • A headset is connected. → When a headset is connected, audio input from Boundary Microphones is disabled. To use the Boundary Microphones, disconnect the headset. • There may be a problem with your communication lines. → Contact your dealer.
The sound cuts out.	<ul style="list-style-type: none"> • You are too far from a microphone. → Speak close to a microphone. • The microphone or unit is being moved during a video conference call. → Do not move the unit or the microphone during a video conference call. • The microphone is being obstructed. → During the video conference call, do not block the microphone with your hand or other object. • There may be a problem with your communication lines. → Contact your dealer.

Problem	Cause and Solution
<p>The sound volume is low or cannot be heard at all.</p>	<ul style="list-style-type: none"> • The unit's volume settings are too low. → Increase the volume level (Page 85). <p>Note</p> <ul style="list-style-type: none"> • You can set the volume level of a video conference call before starting the call. Confirm the settings (Page 128). <ul style="list-style-type: none"> • The other party's microphone has been muted. → Have the other party unmute their microphone. • The display's volume settings are too low. → Increase the volume level of the display. • A headset is connected. → When a headset is connected, audio output from the display or speakers is disabled. Disconnect the headset. • The "Other Site's Audio" setting of a profile's setup or "Other Site's Audio" in the communication menu is set to "Mix (Selection)", and "Audio Mixing Site" is not set. → Set "Audio Mixing Site" in the profile setup or the communication menu (Page 82, Page 110).
<p>You hear audio feedback.</p>	<ul style="list-style-type: none"> • The microphone is too close to the display or to speakers. → Keep microphones at least 1 m away from any display or speaker. • The display's volume settings are too high. → Decrease the volume level of the display.
<p>Sound cuts out or echoes.</p>	<ul style="list-style-type: none"> • Adjustments to the environment immediately after a video conference call has begun may not yet have completed. → Immediately after a video conference call has begun, be sure to speak in turn with other parties. The unit will automatically adjust audio levels so that all parties can easily be heard.
<p>The other party hears noise.</p>	<ul style="list-style-type: none"> • The Boundary Microphone cable is not properly connected. → Check that the Boundary Microphone is properly connected to the unit (Page 30).
<p>The orientation of the image and sound do not match (the voice of a person on a side of the screen comes from the opposite side's speaker, etc.).</p>	<ul style="list-style-type: none"> • The speakers are not properly positioned. → Position speakers on either side of the display and check that the left/right wiring is correct. If you place the display at the front of the room and the speakers at the back, the microphone's left/right spatial direction may be reversed, and the orientation of the image and sound will not match. • The speakers of the other party are not properly positioned. → Ask the other party to position speakers on either side of the display. When the MIC position is set automatically, if the other party places the display at the front of the room and the speakers at the back, the microphone's left/right spatial direction may be reversed, and the orientation of the image and sound will not match. • The MIC positions set manually by the other party are incorrect. → Ask the other party to confirm the manual settings of their MIC positions. When setting the MIC position manually, the left/right orientation should match the left/right channels as viewed from the side of the main video camera. When the MIC position is set to "Center stereo", make sure that it is placed with its connector facing the display (Page 128).

System Settings

Problem	Cause and Solution
The settings of the unit cannot be changed.	<ul style="list-style-type: none"> • A video conference call is in progress. → Make settings after ending the current video conference call. • A video conference call is incoming. → A dialogue box will be displayed asking whether to answer the call. Press [END] to disconnect the incoming call, and then configure the setting on the unit. → If a video conference call is received when editing settings on the unit, a dialogue box will be displayed asking whether to answer the call without saving the settings, and you will temporarily be unable to edit the settings. To continue editing, reject the call.

If These Messages Appear

Message	Cause and Solution
Call failed. Encryption settings (On/Off) must match. Please change the encryption setting on one side and try again.	<ul style="list-style-type: none"> • The encryption settings do not match those of the other party in a video conference call. → Change the encryption settings to match those of the other party (Page 123, Page 123, Page 140).
Call Failed due to wrong encryption key. Please contact your installer.	<ul style="list-style-type: none"> • The encryption key settings do not match those of the other party in a video conference call. → Ensure your encryption key setting matches the other party's (Page 141).
Check the Main Camera connection.	<ul style="list-style-type: none"> • A cable or cord is not properly connected. → Check that all cables to the unit are connected properly (Page 23). • The signal input from the main video camera is invalid. → A valid signal cannot be received from the connected main video camera. Contact your dealer.
Unable to register, the contact list is full.	<ul style="list-style-type: none"> • The contact list has reached its maximum capacity. → Delete unneeded contacts (Page 106).
Invalid IP Address.	<ul style="list-style-type: none"> • The format of the IP address that you entered is invalid. → Enter the IPv4 address correctly, in the format XXX.XXX.XXX.XXX (decimal values separated by periods). For values of only 1 or 2 digits, enter these numbers as they are. Do not enter like [.001]. Example: The IP address is [192.168.0.1]. <ul style="list-style-type: none"> – Correct entry: [192.168.0.1] – Wrong entry: [192.168.000.001] • Multicast or broadcast addresses cannot be used. → Enter a valid IPv6 address. For the IPv6 address input format, refer to Page 47.

Message	Cause and Solution
Invalid Subnet mask.	<ul style="list-style-type: none"> • The input subnet mask is invalid. → Enter a valid subnet mask. For values of only 1 or 2 digits, enter these numbers as they are. Do not enter like [.000]. Example: The subnet mask is [255.255.255.0]. <ul style="list-style-type: none"> – Correct entry: [255.255.255.0] – Wrong entry: [255.255.255.000]
Invalid Default Gateway.	<ul style="list-style-type: none"> • The input default gateway is invalid. → Enter a valid default gateway for IPv4 addresses. For values of only 1 or 2 digits, enter these numbers as they are. Do not enter like [.001]. Example: The default gateway is [192.168.0.1]. <ul style="list-style-type: none"> – Correct entry: [192.168.0.1] – Wrong entry: [192.168.000.001] → Enter a valid default gateway for IPv6 addresses. For the IPv6 address input format, refer to Page 47.
Invalid Date/Time.	<ul style="list-style-type: none"> • Enter a date within the valid parameters. → Enter a date between January 1, 2017 and December 31, 2035.
PC is not connected. Check the connection.	<ul style="list-style-type: none"> • A cable or cord is not properly connected. → Check that all cables to the unit are connected properly (Page 34). • The computer is not turned on. → Turn on the computer. • The computer is not set to output from its external monitor video out port. → Change the computer's settings so that video is output from the external monitor port.
Sub-Camera is not connected. Check the connection.	<ul style="list-style-type: none"> • A cable or cord is not properly connected. → Check that all cables to the unit are connected properly (Page 34). • The sub video camera is not turned on. → Turn on the sub video camera.
Sub-Camera source is not compatible.	<ul style="list-style-type: none"> • A cable or cord is not properly connected. → Check that all cables to the unit are connected properly (Page 34). • The signal input from the sub video camera is invalid. → A valid signal cannot be received from the connected sub video camera. Contact your dealer.
Different video frequency or resolution of TV is connected with HDMI n. Note <ul style="list-style-type: none"> • "n" is displayed as the HDMI terminal's number (1 to 3). 	<ul style="list-style-type: none"> • A display with a video frequency different from that of the unit was connected. → Match the unit's video frequency to the display being used. • A display that does not support 1920 × 1080 resolution was connected. → Use a display that supports 1080 resolution. <p>Note</p> <ul style="list-style-type: none"> • The resolution of all connected displays will be lowered. When the terminal connected to the display indicated in the message is disconnected, the resolution will return to full HD. • The output for the terminal indicated in the message will display as "Unsupported" in the unit information screen.

Message	Cause and Solution
Check display resolution.	<ul style="list-style-type: none"> • The computer's display resolution is incompatible with the unit. → Set your computer's resolution to a setting compatible with the unit (Page 89).
<p>n is already in use.</p> <p>Note</p> <ul style="list-style-type: none"> • The IP address is represented by n. 	<ul style="list-style-type: none"> • On the network you are using, another device is already using the IP address you have input for the unit. → Make sure that all devices on the network have unique IP addresses assigned.
Cooling Fan Malfunction. Please turn off the system and call for service.	<ul style="list-style-type: none"> • The CPU cooling fan within the device has stopped (displayed for models except the KX-VC2000). → Quickly turn off the power. Contact your dealer.
Cooling Fan Malfunction. Power automatically turns off.	<ul style="list-style-type: none"> • The CPU cooling fan within the device has stopped (displayed for the KX-VC2000). → Contact your dealer.
Call Failed due to unsupported product or other error.	<ul style="list-style-type: none"> • An unsupported feature was used. → Check the software version of all parties. Update the unit so that the versions match. For details about supported versions and features, contact your dealer. • Connection to an unsupported MCU or non-Panasonic video conference system was attempted. → For details about supported MCUs and non-Panasonic video conference systems, contact your dealer.
Call disconnected due to codec negotiation failed.	<ul style="list-style-type: none"> • The other party's device uses an unsupported codec. → Have the other party check their settings.

Message	Cause and Solution
<p>Received remote control ID (n1). The unit current setting is (n2). Press [Home] button using the correct remote control, or setup remote control as follows.</p> <ol style="list-style-type: none"> 1. Press [.] and [#] at the same time. 2. Within 2 seconds, press [n2]. 3. Press [Home] to finish, this message will disappear. <p>If this message will not disappear, please check the batteries in your remote control and try again.</p> <p>Note</p> <ul style="list-style-type: none"> • The remote control ID of the remote control (1/2/3) is represented by n1. • The remote control ID of the unit (1/2/3) is represented by n2. 	<ul style="list-style-type: none"> • The remote control IDs of the unit and remote control do not match. <p>→ Follow the on-screen instructions to change the remote control ID of the remote control to match that of the unit.</p> <p>→ If you cannot change the remote control ID of the remote control, contact your dealer.</p> <p>→ If multiple remote controls with assigned IDs will be used close together or if you do not want this message to be displayed, select "OFF" for "Check ID mismatch" (Page 130).</p>
<p>The address is invalid.</p>	<ul style="list-style-type: none"> • The IP address contains an invalid value. <p>→ Enter the IPv4 address correctly. The correct format is XXX.XXX.XXX.XXX (dotted format decimal notation). If the IPv4 address contains 1 or 2 digit numbers, enter these numbers as they are. Do not enter like [.001]. Example: The IP address is [192.168.0.1].</p> <ul style="list-style-type: none"> – Correct entry: [192.168.0.1] – Wrong entry: [192.168.000.001] <p>Multicast or broadcast addresses cannot be used.</p> <p>→ Enter a valid IPv6 address. For the IPv6 address input format, refer to Page 47.</p> <p>→ When making a call by specifying an IPv6 address port number, enclose the IPv6 address in square brackets as shown below. [2001:db8::10]:5060</p> <ul style="list-style-type: none"> • The address information contains an invalid value. <p>→ Enter the information correctly (Page 47).</p>
<p>Cannot transmit to the local site. Check the address.</p>	<ul style="list-style-type: none"> • The IP address of the other party is the same as your own IP address. <p>→ Register the correct IP address.</p>
<p>Calling the same site. Check the address.</p>	<ul style="list-style-type: none"> • In a multiple-party video conference call, one or more of the parties is using the same IP address. <p>→ Register the correct IP address.</p>

Message	Cause and Solution
Invalid Primary DNS Server address.	<ul style="list-style-type: none"> The IP address contains an invalid value. → Enter the IPv4 address correctly. The correct format is XXX.XXX.XXX.XXX (dotted format decimal notation). If the IPv4 address contains 1 or 2 digit numbers, enter these numbers as they are. Do not enter like [.001]. Example: The IP address is [192.168.0.1]. <ul style="list-style-type: none"> Correct entry: [192.168.0.1] Wrong entry: [192.168.000.001] Multicast or broadcast addresses cannot be used.
Invalid Secondary DNS Server address.	
Please enter different addresses for each DNS Server.	<ul style="list-style-type: none"> The addresses of the primary and secondary DNS servers are the same. → Enter different IP addresses (Page 119).
Invalid Primary DNS Server address (IPv6).	<ul style="list-style-type: none"> The format of the IP address that you entered is invalid. → Enter a valid IPv6 address. For the IPv6 address input format, refer to Page 47.
Invalid Secondary DNS Server address (IPv6).	
Please enter different addresses for each DNS Server (IPv6).	<ul style="list-style-type: none"> The addresses of the IPv6 primary DNS server and IPv6 secondary DNS server are the same. → Enter different IPv6 addresses (Page 120).
Connection will be closed in n seconds. Press "YES" to continue. Note <ul style="list-style-type: none"> The message first appears when one minute remains and "60" is displayed for n. Then, the remaining time starts to decrease. 	<ul style="list-style-type: none"> The time set for "Call Limit time" has one minute remaining (Page 123). → If you select " Yes ", you can extend the call limit time for the amount set for " Call Limit time ". If you select " No ", the call is disconnected.
Unable to connect to network. (XXXX XXXX) Note <ul style="list-style-type: none"> An error code (consisting of numerals) is displayed in "XXXX XXXX". 	<ul style="list-style-type: none"> The LAN cable is not connected properly, and therefore you cannot make a video conference call. → Check that the LAN cable is connected to the unit properly. Try making a call again, after confirming that the IP address, SIP user name, etc., is displayed on the Home screen. If transmission still fails, make a note of the error code and contact your dealer. Note <ul style="list-style-type: none"> If transmission fails due to the LAN cable not being connected properly, it may take up to 10 minutes before the IP address, SIP user name, etc., is displayed and video conference calls can be made after reconnecting the LAN cable.

Message	Cause and Solution
Disconnected.	<ul style="list-style-type: none"> • When connecting to an MCU or non-Panasonic video conference system, the video conference call was disconnected. → When connecting to an MCU or non-Panasonic video conference system, encryption may not be available or some operations may not function as expected, depending on the device used by the other party. In this case, contact your dealer. • When connecting to an MCU or non-Panasonic video conference system, the video conference call was disconnected for an unknown reason. → Wait a while and then try making the video conference call again. If video conference calls get disconnected repeatedly, contact your dealer.
Feature is not available with current connection.	<ul style="list-style-type: none"> • The other party cannot display the computer's screen because their display does not support the selected resolution. → Change the resolution setting to a resolution that is supported by the other party. → Contact your network administrator. • Tone signals could not be sent because the other party's device does not support tone signals. → Ask the other party to check their configuration.
Invalid Operation.	<ul style="list-style-type: none"> • Your video camera is not a video camera supported by this unit. → Use a video camera that is supported by this unit. For details, contact your dealer. • You are trying to use a function that is not supported by your video camera. For example, you tried to use the pan function with a video camera that supports only the zoom function. → Check whether your video camera supports the function you are trying to use. • You are trying to change the call type during a video conference call using the selected local site. → Stop the video conference call using the selected local site, and then change the call type.
Invalid SIP Server Address.	<ul style="list-style-type: none"> • The format of the SIP server address that you entered is invalid. → Enter the SIP server address for IPv4 addresses correctly. Enter the SIP server address as XXX.XXX.XXX.XXX (values separated by decimals). For values of only 1 or 2 digits, enter these numbers as they are. Do not enter like [.001]. Example: The IP address is [192.168.0.1]. <ul style="list-style-type: none"> – Correct entry: [192.168.0.1] – Wrong entry: [192.168.000.001] Multicast or broadcast addresses cannot be used. → Enter a valid IPv6 address. For the IPv6 address input format, refer to Page 47.
Invalid SIP Domain Name.	<ul style="list-style-type: none"> • The format of the SIP domain name that you entered is invalid. → Enter a standards-compliant value. For details, contact your network administrator.

Message	Cause and Solution
Invalid WAN IP Address.	<ul style="list-style-type: none"> • The format of the router's WAN IP address that you entered is invalid. → Enter the WAN IP address correctly, in the format XXX.XXX.XXX.XXX (decimal values separated by periods). For values of only 1 or 2 digits, enter these numbers as they are. Do not enter like [.001]. Example: The IP address is [192.168.0.1]. <ul style="list-style-type: none"> – Correct entry: [192.168.0.1] – Wrong entry: [192.168.000.001] Multicast or broadcast addresses cannot be used.
Invalid Gatekeeper Address.	<ul style="list-style-type: none"> • The format of the gatekeeper's IP address that you entered is invalid. → Enter the gatekeeper address for IPv4 addresses correctly. Enter the gatekeeper address as XXX.XXX.XXX.XXX (values separated by decimals). For values of only 1 or 2 digits, enter these numbers as they are. Do not enter like [.001]. Example: The IP address is [192.168.0.1]. <ul style="list-style-type: none"> – Correct entry: [192.168.0.1] – Wrong entry: [192.168.000.001] Multicast or broadcast addresses cannot be used. → Enter a valid IPv6 address. For the IPv6 address input format, refer to Page 47.
Failed to save data.	<ul style="list-style-type: none"> • You are using a USB memory device that is not compatible with the unit. → Use a USB memory device compatible with the unit (Page 156). • There is not enough free space on the USB memory device you are using. → Confirm the USB memory device has sufficient free space (at least 50 MB) before using it.
Invalid Operation. Initial setting is not completed.	<ul style="list-style-type: none"> • In local site settings, you tried to select and save a connection mode without completing network settings. → Before making local site settings, change the connection mode (Page 142) and make network settings (Page 118).
Network error has occurred. Check the network. (LANn) Note <ul style="list-style-type: none"> • The LAN number (1 or 2) is displayed where "n" is. 	<ul style="list-style-type: none"> • A problem has occurred on the network such as a network loop. → Check the LAN cables and network equipment. If it has been detected that the network problem has resolved, the following messages are displayed. In this case press [ENTER]. The network is normal. Press [ENTER] and restart the system.
System Error! Please restart the system. If error message appears again, please contact Installer or Service Administrator. * System may restart automatically.	<ul style="list-style-type: none"> • The unit's internal software failed to start up. • The unit failed to write data to the internal flash memory. → If the unit does not restart automatically after 20 seconds, restart the unit by turning off its power, then turning it back on. If the same message is displayed after resetting the unit, contact your dealer.
Failed to obtain the WAN IP Address.	<ul style="list-style-type: none"> • There was an error in receiving the WAN address from the external server. → Contact your dealer.

Message	Cause and Solution
Software update failed. (3996 0BBB)	<ul style="list-style-type: none"> The USB memory device does not contain the appropriate firmware. The firmware is incorrect. → Confirm that the correct firmware is saved to the USB memory device. For details about the firmware, contact your dealer.
Software update failed. (3996 0BBB) Restart the system.	
Administrative rights are required for this operation.	<ul style="list-style-type: none"> The operation has been restricted in the administrator menu. → Contact your network administrator.
Invalid Operation. This site is not an MCU site.	<ul style="list-style-type: none"> A menu option that cannot be executed is selected. → During a one-to-one connection video conference, operations for a multiple-party video conference call cannot be performed.
Invalid Operation. Content is being shared.	<ul style="list-style-type: none"> A menu option that cannot be executed is selected. → When contents are being shared using single-stream communication during a multiple-party video conference call using a built-in MCU, at the Main Site the communication menu items " Make a call " and " Main Position set. " cannot be selected.
Invalid Operation. USB recording is in progress.	<ul style="list-style-type: none"> An operation or menu option that cannot be executed during USB recording is selected. → Operate after stopping USB recording.
There is a problem with the USB flash drive write speed. Replace the USB flash drive.	<ul style="list-style-type: none"> An error has occurred when writing the recording data. → The write speed of a USB memory device may decline due to deterioration over use in long periods or other causes. Replace the USB memory device. If you continue recording without replacing the USB memory device, recorded images may be corrupted or cut out.
Invalid Operation. Not enough free space on USB flash drive.	<ul style="list-style-type: none"> There is insufficient free space in the connected USB memory device. → Connect a USB memory device with sufficient free space according to your required recording time and quality. For the required amount of free space of different qualities, refer to Page 184.
Invalid Operation. The device is in USB Device Mode.	<ul style="list-style-type: none"> You cannot make or receive calls or use a USB memory device while in USB Device Mode. → Set " USB Device Mode " to " OFF " (Page 133).
Invalid Operation. The function needs activation.	<ul style="list-style-type: none"> A menu option that cannot be executed unless the feature is enhanced is selected. → Confirm the required activation key (Page 20) and refer to " Enhancement " (Page 158) to enhance the feature. For details, contact your dealer.

Registration Page of KX-VC Series NAT Traversal Service

Basic Operation

Problem	Cause and Solution
The language displayed on the screen is a foreign language.	<ul style="list-style-type: none"> The language setting is incorrect. → In the upper right of the login screen, select your preferred language from the drop-down list (Page 166).

Problem	Cause and Solution
I cannot log in to the device application screen.	<ul style="list-style-type: none"> • The characters displayed in the image were not entered correctly. → Check that the capitalization of characters is correct, and then try entering them again. → Check that you have not entered any unused characters, and then try entering them again. The following characters are not used. <ul style="list-style-type: none"> – Uppercase letters: I O – Lowercase letters: c i j l o s u v w x z

If These Messages Appear

Message	Cause and Solution
Invalid Activation Key entered.	<ul style="list-style-type: none"> • The Activation Key No. or the Registration ID you entered is incorrect. → Check the information written on the activation key to ensure it is entered correctly.
Activation Key already registered.	<ul style="list-style-type: none"> • The Activation Key No. and Registration ID you entered is already in use by another HD Visual Communication Unit. • You entered an Activation Key No. and Registration ID that have been used for registration in the past. → Enter the information written on an activation key that has not been used yet. If the message still appears, contact your dealer.
This Trial licence already registered.	<ul style="list-style-type: none"> • You are trying to use a different activation key after completing registration using the included activation key. → Do not use an activation key other than the one included with the product.

KX-VC Series NAT Traversal Service for this Device

Problem	Cause and Solution
I registered a Registration Key, but I cannot make a video conference call using KX-VC Series NAT Traversal Service.	<ul style="list-style-type: none"> • The connection mode is not set to "NAT Traversal Mode". → Set the connection mode to "NAT Traversal Mode" (Page 142).
After registering a Registration Key and restarting the unit, the Terminal ID is not displayed in the upper right of the Home screen even after 5 minutes.	<ul style="list-style-type: none"> • The LAN cable is not connected correctly. → Check that it is connected to the unit properly. • Router settings for your Internet connection are incorrect. → Set your router correctly, following the router's documentation, and in accordance with setting information supplied by your Internet provider. • Packet filtering or port forwarding is enabled on the router. → Disable these features on the router. For details, refer to your router's documentation.

Problem	Cause and Solution
I extended the service period, but the Terminal ID is not displayed on the Home screen.	<ul style="list-style-type: none"> You did not restart the unit after registering on the KX-VC Series NAT Traversal Service registration page. Restarting the unit is necessary to apply the registration information. → Turn off power to the unit, and then turn it back on to restart the unit.
The service period has not been extended even though a service period extension was performed.	<ul style="list-style-type: none"> You did not restart the unit after registering on the KX-VC Series NAT Traversal Service registration page. Restarting the unit is necessary to apply the registration information. → Turn off power to the unit, and then turn it back on to restart the unit.

If a message from the KX-VC Series NAT Traversal Service is displayed

Message	Cause and Solution														
Failed Registration Key code authentication.	<ul style="list-style-type: none"> You are trying to register an invalid Registration Key. → Recheck the information of the Registration Key that was issued (Page 167), then repeat the registration (Page 158).														
Unable to connect to network. (XXXX XXXX) Note <ul style="list-style-type: none"> An error code (containing alphanumeric characters) is displayed in "XXXX XXXX". 	<ul style="list-style-type: none"> The router or the LAN cable is not connected correctly to the unit, and therefore you cannot make a video conference call. The following table explains the error codes: <table border="1" data-bbox="604 1115 1385 1543"> <thead> <tr> <th>Error Code</th> <th>Explanation</th> </tr> </thead> <tbody> <tr> <td>10000001</td> <td>Registration to the gate keeper failed.</td> </tr> <tr> <td>01000003</td> <td>The DHCP lease expired.</td> </tr> <tr> <td>01000006</td> <td>There was a change due to an extension of the DHCP lease.</td> </tr> <tr> <td>01000007</td> <td>The DHCP network information is invalid.</td> </tr> <tr> <td>05000008</td> <td>Registration to the SIP server failed.</td> </tr> <tr> <td>05000009</td> <td>TCP connection was lost in NAT Traversal Mode.</td> </tr> </tbody> </table> → Check that the router and/or LAN cable are correctly connected to the unit. (Directly connect the router to the unit and check operation. Also try replacing the LAN cable, and then check operation.) If the devices are connected correctly, the router's settings may be incorrect, or the unit may be malfunctioning. Contact your dealer. Note <ul style="list-style-type: none"> When transmission between the unit and the router is interrupted because the LAN cable is connected incorrectly, it may take up to 10 minutes before the Terminal ID is displayed and video conference calls can be made after reconnecting the LAN cable. 	Error Code	Explanation	10000001	Registration to the gate keeper failed.	01000003	The DHCP lease expired.	01000006	There was a change due to an extension of the DHCP lease.	01000007	The DHCP network information is invalid.	05000008	Registration to the SIP server failed.	05000009	TCP connection was lost in NAT Traversal Mode.
Error Code	Explanation														
10000001	Registration to the gate keeper failed.														
01000003	The DHCP lease expired.														
01000006	There was a change due to an extension of the DHCP lease.														
01000007	The DHCP network information is invalid.														
05000008	Registration to the SIP server failed.														
05000009	TCP connection was lost in NAT Traversal Mode.														

Message	Cause and Solution
<p>Service will expire soon! Please purchase and register new Activation Key Card to avoid interruption of NAT Traversal Service. Expiration date could be checked at Enhancement screen.</p>	<ul style="list-style-type: none"> • Your service period may have passed 3 months. → Purchase a new activation key, and extend the service period (Page 168).
<p>Service expired! Please purchase and register new Activation Key Card to activate NAT Traversal Service.</p>	<ul style="list-style-type: none"> • The service period has expired. → If within 6 months since expiration: Purchase a new activation key, and extend the service period (Page 168). → If 6 months or more since expiration: Purchase a new activation key, and then acquire a new Registration Key, and re-register to the unit (Page 158, Page 165). <p>Note</p> <ul style="list-style-type: none"> • To determine whether it has been more than 6 months since the service period expired, see "Checking Enhanced Features".
<p>Due to server issues, the NAT Traversal Service is temporarily unavailable. We are very sorry for any inconvenience.</p>	<ul style="list-style-type: none"> • An error has occurred on the NAT Traversal Service server. → Wait a while, and then try connecting again. If you still cannot connect, contact your dealer.

System Specifications

Unit		KX-VC2000	KX-VC1600	KX-VC1300	KX-VC1000
Communication Protocol		SIP, H.323			
Video Compression Method		H.261 (Main Stream only), H.263, H.263+, H.263++ (reception only), H.264 High Profile, H.264 Baseline Profile			
Audio Compression Method		G.711 μ -law, A-law (3.4 kHz@64 kbps) G.722 (7.0 kHz@64 kbps) G.722.1 (7.0 kHz@32 kbps) G.722.1 Annex C (14.0 kHz@48 kbps/24 kbps) MPEG-4 AAC-LD Mono (7.0 kHz@32 kbps, 14.0 kHz@64 kbps, 22.0 kHz@96 kbps) MPEG-4 AAC-LD Stereo (14.0 kHz@64 kbps, 22.0 kHz@96 kbps)			
		No. of Channels: G.711/G.722/G.722.1/G.722.1 Annex C: 1 MPEG-4 AAC-LD Mono: 1/MPEG-4 AAC-LD Stereo: 2			
Remote Camera Control		H.224, H.281 (Zoom/Pan/Tilt/Preset)			
Dual Stream	Method	H.239 (H.323), BFCP (SIP)			
	No. of Displays	3 displays	2 displays	1 display (Expandable to 2 displays)	
	Supported Resolution and Frame Rate	Main: Maximum 1080p 30 frames/sec. Sub: 1080p 30 frames/sec.			
Encryption		SRTP (AES 128-bit), H.235 (AES 128-bit)			
Other		H.460			
Communication Bandwidth		256 kbps–24 Mbps	256 kbps–18 Mbps		
Video	Compatible Resolutions ¹	176 × 144p, 352 × 240p, 352 × 288p, 512 × 288p, 640 × 480p, 704 × 480p, 704 × 576p, 768 × 432p, 800 × 600p, 1024 × 768p, 1280 × 720p, 1280 × 768p, 1280 × 800p, 1920 × 1080p			
	Frame Rate	Maximum 60 frames/sec. (When using H.264 1080p)			
	Screen Display	Full screen, Picture in Picture, Picture with Picture, Side by Side			
Audio		Echo Cancellor, Auto Gain Control, Stationary Noise Reduction, Lip Sync, Equalizer, Mic Mute			

Unit			KX-VC2000	KX-VC1600	KX-VC1300	KX-VC1000	
Input/ Output Terminals	Video Input	Camera ²	HDMI Main × 1, HDMI Sub × 1 Input Resolution: 1280 × 720p, 1920 × 1080i, 1920 × 1080p				
		PC	RGB × 1 (Mini D-sub 15pin), HDMI × 1 ² Input Resolution: VGA, SVGA, XGA, HD, WXGA, SXGA, FWXGA, WXGA+, WXGA++, UXGA, WSXGA+, Full HD				
	Video Output	HDMI × 2			HDMI × 1 (Expandable to 2)		
		Supported HDMI output resolutions: 1920 × 1080i, 1920 × 1080p					
		RCA × 1 (Component) HDMI × 1 (For own site/recording video)	—		—		
	Audio Input	Boundary Microphone (Digital Interface Type) × 1 (KX-VCA001) (Up to 4)			—		
		Boundary Microphone (Analogue Interface Type) × 1 (KX-VCA002) (Up to 1) HDMI Stereo mini-plug ³ × 1 (ø3.5 mm) RCA × 1 (Stereo)					
	Audio Outputs	HDMI ⁴ Stereo mini-plug ³ × 1 (ø3.5 mm) RCA × 1 (Stereo)					
	Network	RJ45 × 2 (1000BASE-T Full Duplex)	RJ45 × 2 (100BASE-TX Full Duplex)	RJ45 × 1 (100BASE-TX Full Duplex)			
	External Controller	RS-232C × 1 (Also used for maintenance)					
Other	USB 2.0 × 1 (Host Mode, Device Mode), Camera Control terminal × 1 (Not used)						
No. of Simultaneous Connections			16 (Expandable to 24)	6 (Expandable to 10)	4	2 (Expandable to 4)	
Contents Sharing			PC (RGB/HDMI), Sub video camera (HDMI Sub)				
USB Host Mode (USB Memory Device)			Updating Software, Import (Contact List/Profile ⁵ /Configuration Data/Encryption Data/Startup screen/Multicast Tree List), Export (Contact List/Profile ⁵ /Configuration Data/Encryption Data/Multicast Tree List), Recording				
USB Device Mode			USB Video Class: Version 1.0 USB Audio Class: Version 1.0				
Network Protocol			TCP/IPv4, TCP/IPv6 ⁶ , UDP/IPv4, UDP/IPv6 ⁶ , DHCP, DNS, HTTP, HTTPS, TELNET, NTP				
Network Functions			Packet resending (ARQ), Forward Error Correction (FEC), Adaptive Rate Control (ARC), Reorder, Packet Shaping, Arbitrary port setting, NAT support, encryption, IP Precedence/DiffServ support				

Specifications

Unit	KX-VC2000	KX-VC1600	KX-VC1300	KX-VC1000
External Control	Control via web browser/HTTP CGI, TELNET, RS-232C			
Connection Mode	IP mode, NAT Traversal mode, IP / NAT Traversal Mode			
Dimensions (width × depth × height)	Approx. 320 mm × approx. 270 mm × approx. 61 mm (excluding projecting parts) (approx. 12 in × approx. 10 in × approx. 2.4 in)	Approx. 320 mm × approx. 230 mm × approx. 61 mm (excluding projecting parts) (approx. 12 in × approx. 9 in × approx. 2.4 in)		
Weight	Approx. 3.4 kg (approx. 7.5 lb)	Approx. 2.0 kg (approx. 4.4 lb)		
Power Input	AC 100–240 V, 50/60 Hz			
	up to 1.0 A	up to 1.4 A		
Power Consumption	Maximum: 73 W, In standby: 0.6 W	Maximum: 45 W, In standby: 0.6 W	Maximum: 43 W, In standby: 0.6 W	Maximum: 37 W, In standby: 0.6 W
DC Power Input	DC 24 V, 3.0 A	DC 24 V, 2.5 A		
Operating Temperature	0 °C–40 °C (32 °F–104 °F)			
Operating Humidity	10 %–90 % (non-condensing)			

*1 Varies according to device settings and the status of the network.

*2 HDCP is not supported.

*3 For 3-conductor stereo mini-plugs only.

*4 Simultaneous voice audio output for HDMI1/HDMI2 is not supported.

*5 Available for the KX-VC1000 after KX-VCS314 expansion has been enabled.

*6 Some features are not supported when using IPv6.

Index

A

- Activating Enhanced Features 158
- Activation Key 20
- Activation Key for 4 Point Built-in MCU (KX-VCS304) 20
- Activation Key for 4 Point Built-in MCU (KX-VCS305) 20
- Activation Key for 4 Point Built-in MCU (KX-VCS314) 20
- Activation Key for HDMI Dual Monitor (KX-VCS402) 20
- Activation Key for Mobile Connection (KX-VCS351) 20
- Activation Key for Mobile Connection (KX-VCS352) 20
- Activation Key for Multicast (KX-VCS302) 20
- Activation Key for NAT Traversal 1 Year (KX-VCS701) 20
- Activation Key for NAT Traversal 3 Years (KX-VCS703) 20
- Activation Key for PC Peripheral (KX-VCZ501) 20
- Administrator Password, setting 140
- Amplifier/Speaker 35
- Answering a Video Conference Call 63
- Answering, Automatic 64
- Answering, Forced 64
- Answering, Manual 63

B

- Batteries, changing (remote control) 188
- Boundary Microphone 19
 - Boundary Microphone (Analogue Interface Type) 19, 30
 - Boundary Microphone (Digital Interface Type) 19, 30
- Buttons
 - Power 22
 - Remote Control 25

C

- Cables 29
- Call Type, setting 143
- Calling by Entering an Address Directly 56
- Calling from the Call History 59
- Calling from the Contact List 52
- Calling using One-Touch Connection Numbers 51
- Calling using Profile 54
- Cleaning the unit 189
- Codec, setting 147
- Computer 34
- Computer Screen and Sub Video Camera, viewing 89
- Confirming the MPR ID 158
- Connecting to an MCU 65
- Connection
 - Amplifier/Active Speaker 35
 - Computer 34
 - Sub Video Camera 34
- Connection Status, viewing 103
- Connection, setting 121
- Contacts, adding 105
- Contacts, deleting 106
- Contacts, editing 106
- Controlling a Video Camera 92

D

- Date and Time, setting 118

- Device Connection 29

E

- Encryption, setting 140

F

- For Your Safety 11

G

- GUI, setting 153

H

- Headset 34

I

- Initial Settings 48
- Inputting Letters and Numbers 190

K

- KX-VCS302 (Activation Key for Multicast) 20
- KX-VCS304 (Activation Key for 4 Point Built-in MCU) 20
- KX-VCS305 (Activation Key for 4 Point Built-in MCU) 20
- KX-VCS314 (Activation Key for 4 Point Built-in MCU) 20
- KX-VCS351 (Activation Key for Mobile Connection) 20
- KX-VCS352 (Activation Key for Mobile Connection) 20
- KX-VCS402 (Activation Key for HDMI Dual Monitor) 20
- KX-VCS701 (Activation Key for NAT Traversal 1 Year) 20
- KX-VCS703 (Activation Key for NAT Traversal 3 Years) 20
- KX-VCZ501 (Activation Key for PC Peripheral) 20

L

- Language, setting 131
- LED Patterns 27
- Local Site, setting 113

M

- Main Site 3
- Making a Video Conference Call 51
- Making H.323 Settings 145
- Making SIP Settings 144
- MIC Position, setting 128
- Muting the Microphone 86

N

- Network Test, performing 134
- Network, setting 118
- Noise reduction 88

O

- Optional Accessory 18

P

- Part Names and Usage 22
- Ports, Main Unit 23

Index

Power Button 22
Power Management Settings 154
Privacy 14
Protecting Information 14

R

Registering the Registration Key 158
Remote Access 161
Remote Control 25, 39
Remote Control, setting 130
Remote Maintenance, performing 135
Right of Publicity 14

S

Screen Display 41
Screen Layout, changing 71
Screen Standby Mode 27
Screen Standby, setting 127
Security 14
Security Settings 147
Self Diagnosis, performing 134
Software Update, setting 141
Sound, setting 127
Specifications, system 222
Sub Site 3
Sub Video Camera 34
System Initialisation, performing 160

T

Troubleshooting 203

U

Unit Information, viewing 104, 133
Unit Name, setting 118
USB Device Mode 132, 186
USB recording 82, 132, 183
Using Mobile Connection Enhanced Features 171
Using Multicast 172

V

Volume, adjusting 85

Panasonic Corporation
<http://www.panasonic.com>

Panasonic Corporation
Osaka, Japan

Authorised Representative in EU:

Panasonic Testing Centre
Panasonic Marketing Europe GmbH
Winsbergring 15, 22525 Hamburg, Germany



© Panasonic Corporation 2017

PGQX1771PA PD1114KK0108