



**Trademarks and registered trademarks**

- "Super Dynamic", "i-PRO" and "i-PRO SmartHD" logos are trademarks or registered trademarks of Panasonic Corporation.
- HDMI, the HDMI logo and High-Definition Multimedia Interface are trademarks or registered trademarks of HDMI Licensing, LLC.
- ONVIF and the ONVIF logo are trademarks or registered trademarks of ONVIF Inc.
- iPad, iPhone and iPod touch are registered trademarks of Apple Inc.
- Android is a trademark of Google Inc.
- All other trademarks identified herein are the property of their respective owners.

**Important**

- Safety Precaution: Carefully read the Important Information, Installation Guide and operating instructions before using this product.
- Panasonic cannot be responsible for the performance of the network and/or other manufacturers' products used on the network.
- The same catalog is provided for all countries. Some accessories may not be available in some countries.

**Security Cautions**

- When using the products in this catalog, take appropriate measures to avoid the following security breaches:
  - Disclosure of private information via the products.
  - Unauthorized use of products by a third party.
  - Interference or suspension of use of products by third party.

- All pictures are simulated.
- Design and specifications are subject to change without notice.

DISTRIBUTED BY :

# Panasonic

<http://security.panasonic.com>

 <http://www.facebook.com/PanasonicNetworkCamera>

(2B-013LA)

# New Aerodynamic PTZ with EXTREME PERFORMANCE - under - EXTREME CONDITIONS

## AeroPTZ

Suitable for mission critical tough operations under arctic-to-desert weather, salty gust winds, and heavy vibrations

### ● Vibration Resistant Construct

In order to capture stable images, Hybrid image stabilizer (Video SAS technology) reduces vibrations when large vehicles pass and swaying on top of bridges.

### ● Wind Resistant

The camera continues to function even during hurricanes and typhoons of wind speeds up to 216 km/h (135 mph)\* (operation).  
\* Upright position  
The camera will not be damaged by winds up to 288 km/h (180 mph) (non-destructive).

### ● Salt air resistant

The Glass Fiber Body will not be corroded by salt in the ocean breeze.  
ISO14993 Compliant.

### ● Waterproof IP66 & IP67 Standard

The camera can be installed in locations that are frequently wet with heavy rainfall, flood occasionally, or are sprayed with strong spurts of water.

**IP66**  
standard  
**IP67**  
standard

### ● Sustains Harsh Environments

The camera continues to function in extremely cold (-50 °C) and extremely hot (+60 °C)\* environments. (Defroster & Dehumidification Device)

\*Natural Silver model only.  
Gray & Brown model up to +55 °C.



### ● Vandal Resistant

Meets IK10 Standards and is impact resistant.



Panasonic  
WV-SUD638

With optional IR LED Unit

### Wiper & Washer

The Wiper & Washer removes water and dirt that may blur images. Always monitor crisp and clear images.



### Easily Adjust the Direction of the Camera

Use the 360°endless pan and tilt functions to easily adjust the direction of the lens, automatically survey a preset area, or combine the camera with an external sensor to automatically adjust the direction of the lens towards a detected abnormality. Even monitor directly under the camera.

(Front Tilt 45° to Monitor Directly Under the Camera)



### Capture High-Resolution, Smooth & Natural Images



Full HD (1920 × 1080), 60fps

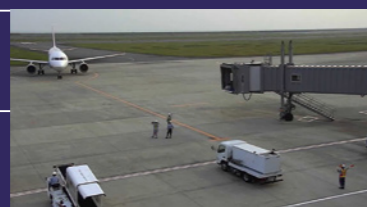

Anti-severe weather PTZ network camera

**WV-SUD638 (Natural Silver)**

**-H(Gray), -T(Brown)**



IR LED Unit

**WV-SUD6FRL1 (Natural Silver)**  
**WV-SUD6FRL-H(Gray), -T(Brown)**

Add the IR LED Unit to monitor extremely dark, 0 lux environments. The IR LED Unit can be attached without altering the external appearance of the camera.



# Ultra-high 4K picture quality for detailed, wide-area monitoring with a single camera. Fewer cameras also means a substantially lower total cost of ownership.

# 4K

ULTRA HD

4K Vandal Resistant Weatherproof Dome Network Camera  
**WV-SFV781L**



4K Vandal Resistant Weatherproof Network Camera  
**WV-SPV781L**



## Ultra high-definition, 4K picture quality

Ultra HD 4K cameras offer 27 times the resolution of conventional analog cameras (VGA), nine times that of standard HD (1,280 x 720) and four times that of Full HD (1,920 x 1,080). This means that the finer details of images remain clear even when you need to magnify only a part of the image. The high performance lens used by Panasonic's 4K cameras provides uniformly high-resolution images from the center out to the edges.



## Cropping Function

A given area within a single image can be selected, cropped and displayed. For example, areas with high monitoring priority, such as a parking garage entrance or a hallway, can be selected and displayed for easy viewing. You can still keep an eye on the overall image while also focusing on specific areas.



With PTZ cameras, when the lens is pointed in a single direction, other areas go out of view during that time, but with a 4K camera you can monitor the entire area while also watching specific areas requiring more focused monitoring.

## Wide-Area Monitoring

A single 4K camera can effectively monitor a wider area, which allows you to reduce the total number of cameras while also eliminating blind spots. Monitoring can be performed not only at vertical and horizontal angles, but for deeper depths as well.

And, even when monitoring within the same area, 4K's increased range means that the number of units required is reduced substantially compared to that of conventional cameras. This translates into reduced costs for the cameras themselves, less installation time and labor, and lower maintenance costs. 4K-ready monitors can also reduce the number of monitors needed in the control room.

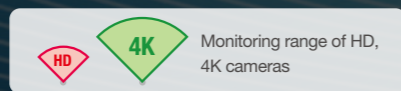
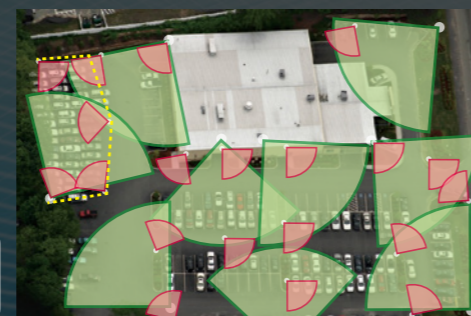

## Low Light Ready

The camera's ultra-high 4K resolution allows it to capture color images in dim, low-light conditions. In even darker conditions, the camera can use its monochrome inversion function to switch to black-and-white images, and in zero-light conditions it can accurately display what is happening in front of it using infrared LED vision.

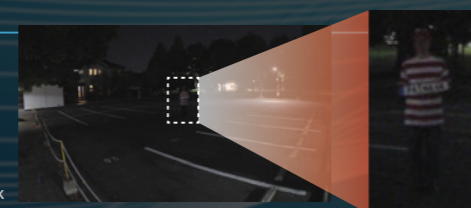

Light near subject : 1 lx

## High-power 6x zoom lens with an ultra-wide angle of 100°

An optical 6x zoom lens comes standard. The viewing angle range and zoom power can be set in line with conditions where the camera is installed. Using a proprietary 3-drive lens system, Panasonic has developed a high-power 6x zoom lens with an ultra-wide viewing angle of 100°, a type of lens that is extremely difficult to produce using conventional optical design methods. The lens is capable of capturing an extremely wide area, allowing effective 4K coverage of outdoor areas.

- Ultra-wide-angle 100° : Wide-angle monitoring of parking lots, stadiums etc. utilizing 4K resolution
- Telephoto 17° : Monitoring of individuals or crowds from a distance.



## This is the Panasonic difference!

Panasonic's "True 4K Technology"



### • Panasonic's Proprietary 3-Drive Lens System

The i-PRO TRUE 4K NW Camera is equipped with Panasonic's proprietary 3-drive lens system, which simultaneously drives two zoom lenses and one focus lens. Having three lenses all driven independently allows them to be smaller and their drive areas reduced, and has thus enabled us to make the camera compact enough to fit in a standard camera body while providing a high-power 6x zoom with high 4K picture quality viewed from an ultra-wide-angle of 100°.

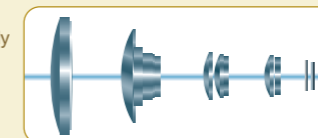

### • Refined Resolution and Superior Contrast for a Higher Level of Video Imaging

In order to create a sharp, clear texture, 12 lenses in four groups are used to provide the ultra-high resolution expected of 4K in every part of the image, from center to edge. Both a higher level of representational precision and a more compact lens system are achieved. Plus, all lenses are glass, while aspheric lenses are also used extensively to reduce aberrations to the ultimate degree. The clear depiction, sharp resolution and beautiful color reproduction necessary for true 4K monitoring have all been successfully achieved.

## Easy Installation

Various design features have been added to shorten installation times. The camera has also been designed to be capable of pointing in the preferred direction at the preferred location.

### Dome Type WV-SFV781L

When attached to the mounting plate, the camera's direction can be easily changed at intervals of 90°. Rotating the viewing area around the lens further allows the lens to be pointed in the desired direction. The combination of a 6x optical zoom and autofocus also shortens the amount of time required for fine tuning the installation.



### Box Type WV-SPV781L

A total of three adjustment points on the camera base and arms enables its position to be fine tuned to allow accurate pointing.

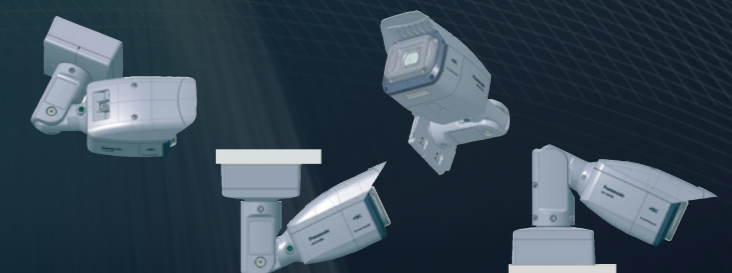

# Delivering sharper images with higher sensitivity. Featuring a more intelligent solution. Introducing the 9 Megapixel 360-degree Network Camera!

**i-PRO**  
**SmartHD**

**ULTRA 360**

360-degree Vandal Resistant Outdoor Dome  
9 Megapixel Network Camera  
**WV-SFV481**



360-degree Indoor Dome  
9 Megapixel Network Camera  
**WV-SFN480**



\*Sample screen from 9M Fisheye mode

● **9M (3K × 3K) high-resolution performance enables sharp rendering of objects and people's faces at the edge sections of the fisheye image.**

**8 m**

WV-SFN480

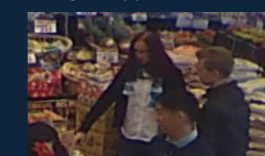

WV-SF438



**4 m**

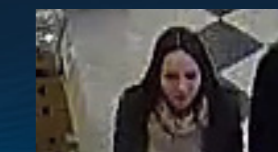

● **Complete with powerful intelligent functions**

**Heat-map\***

This provides visualization of the traffic patterns by people and how long they stay in one place. For example, you can place products based on how people tend to flow within the store and arrange objects so that they do not interfere with the movement of people.



**People Counting\***

This counts the number of people passing through a selected preset location. The People Counting function can provide statistics on the number of people entering and leaving a specific zone and other useful data.



**MOR (Moving Object Remover)\***

Enables monitoring of changes only to the surrounding environment by removing people and other moving objects from the video. This function can be used with camera images for confirming how products placed in a salesroom are selling while also respecting the privacy of customers in store surveillance.

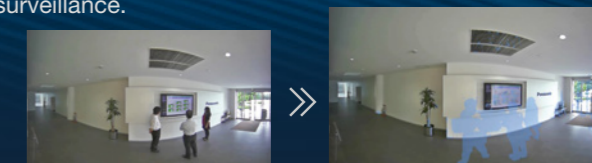

\* Extension software WV-SAE200 is required.

**4K**  
ULTRA HD **ENGINE**

Introducing 360-degree network cameras incorporating a new platform with a 12-megapixel high sensitivity sensor in the i-PRO SmartHD Series. The ULTRA 360-degree lineup features the “**Three Ultras**” for establishing a new standard for video monitoring.

**01 Ultra High Resolution**

Includes a 12-megapixel high-sensitivity sensor capable of 4K image output for producing high-resolution images up to 9M (3K × 3K) in Fisheye mode.  
Detailed monitoring in all directions using the wide range of distribution modes and Multi-stream. (Fisheye mode, Panorama mode, Double Panorama mode, Quad PTZ mode, Single PTZ mode, 4 Stream mode)

**02 Ultra High Sensitivity**

Provides natural-looking, crystal-clear images even in dim locations.  
Includes a new powerful image sensor and new lens.  
Automatic switching between day/night shooting modes and the linked Auto Back Focus enables monitoring even in dim environments.

**03 Ultra Intelligent**

Heat-map / People Counting (Cross line) / MOR (Moving Object Remover)  
Focuses on the movement of people for providing a video-based intelligent solution for use in marketing.

Providing natural looking, sharp video optimized for a wide range of installation environments and conditions.

### High Resolution

The Panasonic i-PRO SmartHD Series of network cameras are high definition (HD) cameras capable of shooting video at Full HD (1,920x1,080) and HD (1280x720). These cameras can record up to 60 images per second (60 fps), even at Full HD resolutions for the capture of exceptionally clear images of moving objects. The resolution, frame rate, and other parameters can be adjusted for the installation location and subject for obtaining the optimum settings for your specific environment.

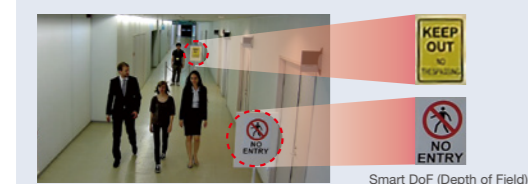
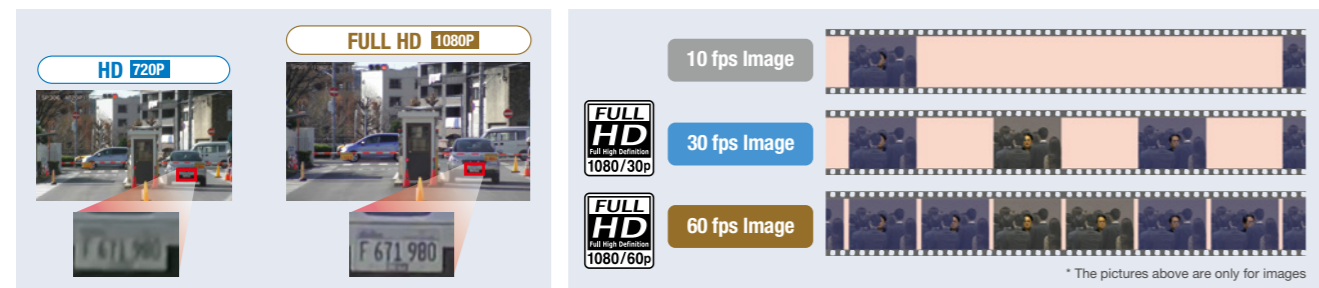

### Smart DoF (Depth of Field)

The i-PRO SmartHD Series cameras are ideal for shooting in locations with depth. When recording areas with depth, such as straight passageways or wide spaces, the optimum image can be captured with focal points simultaneously at both the near and far ends of the image.

### Enhanced Super Dynamic



In installation environments with differences in brightness, the Super Dynamic (SD) function brightens dim areas with low visibility and reduces the brightness of areas where blown-out highlights can occur due to over-brightness, providing a natural image that is easy to view.

In building entrances and similar locations, this enables the capturing of sharp images of people's faces as they enter from the outside when exposed to direct sunlight.

With the Super Dynamic (SD) function, the camera can be installed without worrying about lighting conditions that vary based on the time of day and season.

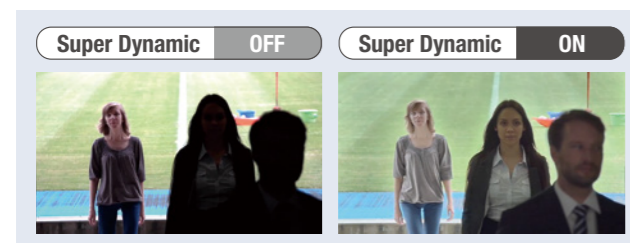

### Day/Night Automatic Mode Switching



In stores, warehouses, and other locations where it is bright during the day but dark at night, the camera can automatically determine the brightness of the area and record video under the optimum conditions. During nighttime hours, the camera automatically switches to black-and-white video for providing footage with high visibility.

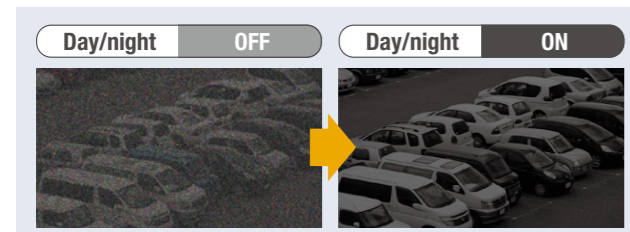

### 0 lux Pitch Dark Locations



Cameras with a **Smart IR LED** can be used to monitor environments that are completely dark.

This enables areas without the level of illumination required to be monitored to prevent graffiti, illegal dumping, and property destruction.

**Smart IR LED** can illuminate a wide area so that monitoring is not limited to a specific part of the image.

The built-in IR LED of the 6 Series can capture subjects up to 30 meters away. Light levels are automatically adjusted for blown out highlights and screen whitening when the IR LED shines on a subject close-by, making the right areas highly visible.

The IR LED is covered to make it difficult to detect from the outside or to know which way the lens is pointing.

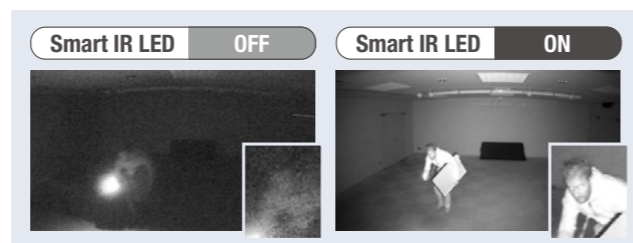

### Strong Low Light Performance in Color

Monitoring is possible even in dim locations. Panasonic's proprietary technology enables high-sensitivity shooting that enables distinguishing of color hues even in dimly-lit locations.

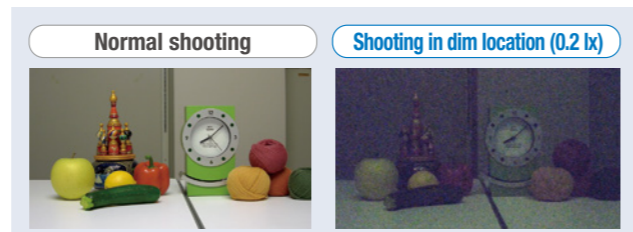

### Fog / Sandstorm Compensation



A full array of features are provided for optimum shooting in fog, sandstorms, and other hazy environments. Haziness due to fog or a sandstorm is automatically removed by this function providing clear, sharp video footage.



This is the Panasonic difference!

### Visibility Enhancement Technology (OP Software)

i-PRO Management Software is not only used for removing fog but also snow, rain, and other natural conditions that can harm video quality.

Besides real-time image processing during monitoring, post-processing is also possible after the images are saved to the recorder.



### Visibility Enhancement Coating



Water droplets from rain can adhere to the dome cover of the camera and hinder the shooting of clear images. In our Rain-wash coated models, a special coating is applied so that water droplets are repelled allowing clear images to be recorded even during rainfall. This coating is also effective at repelling dirt so that cleaning of the dome cover is required less frequently.

\* WV-SFV781L / WV-SPV781L / WV-SW598A / WV-SW397B / WV-SW395A

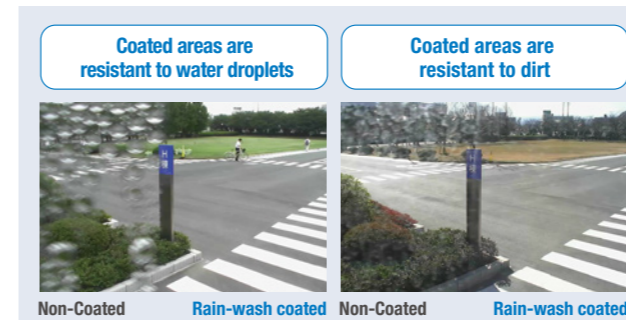

### High Light Compensation



For cameras installed at locations along roads or at entrances and exits to parking lots, the glare of headlights and other strong light sources shining into the camera lens can prevent the reading of license plates and surrounding areas. Enabling the HLC (High light compensation) function reduces the brightness of strong light sources and enhances the surrounding areas for optimum video recording.



### Lens Distortion Compensation

Monitoring of a wide area with a wide angle lens can cause image distortion. The i-PRO SmartHD Series corrects this distortion to produce clear, natural-looking images.



This is the Panasonic difference!

Panasonic provides high-resolution cameras available for a wide array of different environments. Panasonic's full lineup of products enables versatile monitoring for over a broad range of challenging shooting conditions such as adverse weather, harsh environments, and variable time of day and seasons.

# Monitoring 03

## Monitoring without Blind Spots

**PTZ (Pan-Tilt-Zoom) cameras and omnidirectional cameras enable wide-area monitoring. Multiple cameras can be combined for more efficient monitoring and to eliminate blind spots.**

### PTZ Camera for Wide Range Monitoring and a High Zoom Ratio

Normal fixed lens cameras can only monitor in a certain direction, but the lens of a PTZ camera can be operated remotely to switch to the direction you want to view.

Detailed areas can also be zoomed in to a maximum of 90x. Since the cameras can be infinitely rotated 360 degrees at a high speed of 300 degrees/sec, you will not miss the subjects you want to monitor.

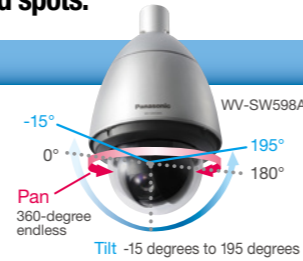

### Preset Position / Preset Sequences

If the locations you want to monitor are fixed, you can register them in advance and move to them with a single touch or automatically patrol the registered locations. Data can be saved to a recorder when automatically patrolling the registered locations, without intervention by an operator.

Ranges that cannot be covered with a single fixed lens camera can be covered by patrolling.



### Advanced Auto Tracking

The pan, tilt, and zoom functions can be combined for automatically tracking the movement of a subject.

If the tracked subject moves out of the camera's shootable range, notification is sent to other cameras so that the tracking process can be carried on without interruption.

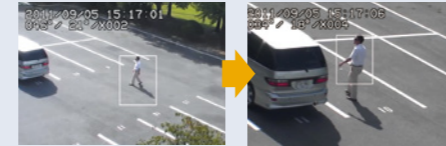

**This is the Panasonic difference!**

### Auto Eyelid Mechanism (AEM)

When the direction of the camera lens is tilted upward from the horizontal plane, the video image can appear doubled due to the distorting effect of the dome cover and other causes. The Panasonic WV-SW598A, WV-SW397B uses an AEM function to reduce this double-image effect and enables shooting of images up to 15° upward from the horizontal plane. This allows the use of auto tracking and other functions over a wider movement range of the subject.



### 360-degree Monitoring

The 360-degree Network Camera can capture images around the camera lens in all directions.

Available modes include Fisheye, Double Panorama, Panorama, Quad PTZ, and 4 Stream, and the camera can output video images based on the selected video mode for reduced loads on the viewing system.



**This is the Panasonic difference!**

### De-warping

The 360-degree Network Camera can generate and output video images for each mode within the camera unit. Also, the Network Disk Recorder (WJ-NV300) or i-PRO Management Software (WV-ASM200) can be used on 360°omnidirectional images captured by Fisheye Mode to convert to a format that is easier to view, such as Quad PTZ. Because the 360°omnidirectional video image is stored in the recorder, nothing is missed within the viewing area.

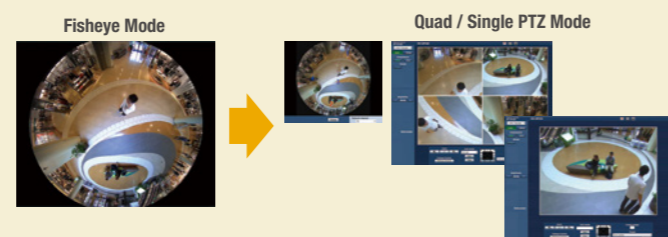

In addition, the area that you want to view can be selected using a controller or mouse to allow you to automatically move the viewing spot for patrolling the area. Even during patrolling, areas not visible on the screen are all stored in the recorder in Fisheye Mode so that nothing is left unseen. The Pan-Tilt of the 360-degree Network Camera does not use mechanical components, and so provides a smooth movement without the mechanized wear that could adversely affect camera longevity.

# Support for Various Installation Environments 01

**Panasonic network cameras are available in a full lineup of products custom-tailored for a wide range of installation environments. Their specialized design also helps to reduce the work required for installation.**

## Select the Specialized Model for Your Installation Environment

### Rainwater protection for outdoor installations

The outdoor models have a waterproof and dustproof structure that is rated IP66 for outdoor installation without requiring insertion in a special housing or other weatherproofing protection.



### Temperature protection for outdoor installations

Models can be selected to match your specific installation conditions and can be installed in environments with temperatures ranging from +55°C to -50°C.

\*The supported temperature range varies depending on the specific model.

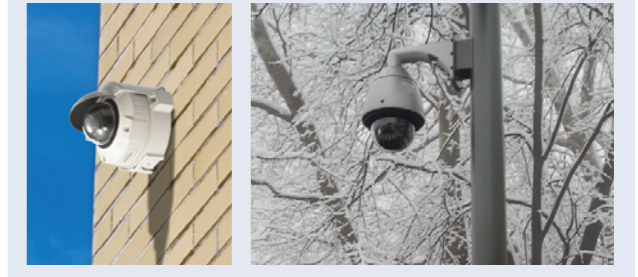

**This is the Panasonic difference!**

### Dehumidification Device

The network camera outdoor models have a built-in dehumidifier device to lower the internal humidity for preventing cloudiness due to condensation. This eliminates blurry video images caused by clouding of the camera dome cover when installed in locations with high humidity or extreme temperature changes over the course of the day.

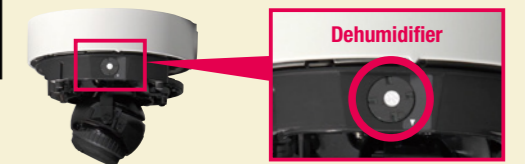

### Vandal Resistant

When installed in locations that are prone to vandalism and tampering, measures are required for preventing damage to the camera. Models featuring the Vandal Resistant mechanism are ideal for installation in these types of locations.



**This is the Panasonic difference!**

### Vandal resistant mechanism

Models featuring the Vandal Resistant mechanism include a shock absorber around the internal lens. Even if the dome cover is subjected to a potentially damaging impact, the shock absorber will absorb this impact to protect the internal structure from damage.

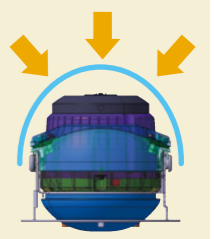

### Onboard Model

A lineup of network cameras is also available with anti-vibration and other specific features for installation in cars, buses, and other vehicles. The WV-SBV131M, WV-SBV111M, WV-SFV130(M), WV-SFV110(M), WV-SW158, WV-SW155MA, WV-SW458MA, and WV-SFV481 are compliant with the EN50155 European railway standards.



### Mount on the Outside of the Vehicle

The rugged mobile network camera WV-SBV131M, WV-SBV111M meets the United States Department of Defense Military Standards MIL-STD-810G to withstand even the harshest of environments. Also meeting the highest International Protection Standards IP6K9K, the camera is dust tight and waterproof.

Meeting such standards allows the camera to be mounted on the outside of busses and trains, which are constantly shaking and rained on.

The lenses' hard coated surface allows the vehicle to be put through a carwash.

Capable of withstanding temperatures ranging from -40 °C and up to +60°C (-40 °F and up to 140°F) the camera is highly versatile.



# Support for Various Installation Environments 02

## Reduced Installation Time

The i-PRO SmartHD Series cameras include a number of features for reducing the time required for installation.

If you want to change the camera direction after installation, the camera direction can be changed in 90° steps without removing the base(SFV, SFR, SFN models).

The dome cover can also be easily removed to change the direction of the lens.

For Outdoor Box type cameras(SPW models), the stay can be bent to one of two levels to allow installation with a high degree of freedom.

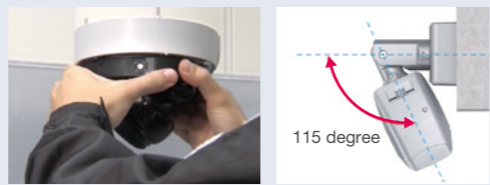

## ABF (Auto back Focus)

The ABF feature automatically adjusts the image sensor position when changing from color to B/W mode, optimize the back focus required for clear, sharp images.

In addition, the one-push Auto Back Focus feature sharply reduces the time required to focus cameras during installation, allowing focus to be set using the optional system controller.

The ABF function can also automatically sense and adjust to slight focal length changes due to parts warping caused by temperature changes in the area where the camera is installed.

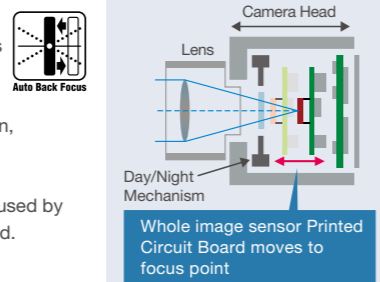

## Special Screws for Added Security

Specially-shaped screws are used to secure the cover to prevent tampering with the camera or theft of the SD memory card.

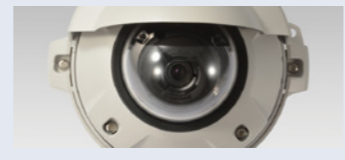

# Network 01

Panasonic network cameras and network disk recorders are designed for seamless compatibility with your network and for reduced loads when connected to the network.

## Features for Reducing Network Loads

### Smart Coding

In order to reduce the size of the data file, Smart Coding reduces the resolution of unnecessary scenes, such as the sky in the background, while maintaining the resolution of the scenes within the frame that need to be monitored.

Reducing the size of the data file extends the recording duration and reduces the load on the network.

### • GoP (Group of pictures) control

H.264 codec is comprised of I-Frame, which records all video information, and other frames that depict the difference.

Although information encoded at regular intervals with I-Frame is necessary, collecting all the data will increase the size of the data file.

While maintaining smooth, high quality video, Smart Coding reduces the size of the file by cropping the motionless I-frame scenes.

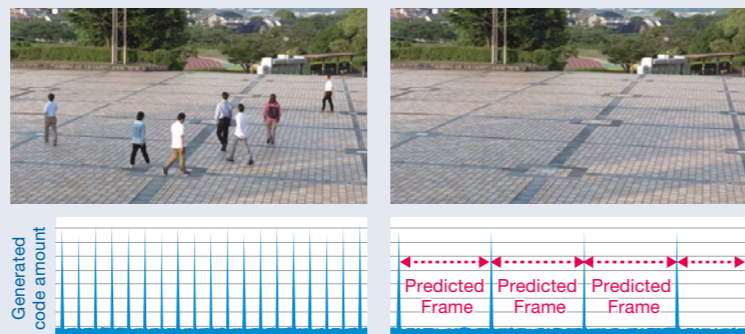

When people are walking, I-frame is inserted at regular intervals as usual.

When there is no person walking, I-frames are thinned down to reduce the amount of data.

### • Auto VIQS (Variable Image Quality on Specified Area)

The camera automatically detects and reduces the resolution of stationary scenes within the frame, which reduces the size of the data file. Retaining high-resolution of the scene within the frame that needs to be monitored improves monitoring efficiency.

The scene shown to the right, for example, displays the lowered resolution of unnecessary scenes, such as the sky, while maintaining the resolution of the road where cars are moving.

Turn the Smart Coding settings to "High" to automatically activate Auto VIQS.



# Network 02

## Noise Reduction

### • FDF (Frequency Divided Filter)

Removing fine noise generated under low illumination to achieve a low bit rate.



### • 3D-MNR (3D-Multi-process Noise Reduction)

Removing grain noise generated under low illumination to achieve a low bit rate.

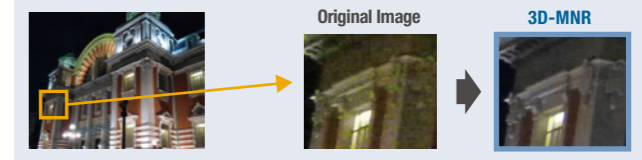

## Various transmission modes

Five transmission modes are available (Constant bit rate, Frame rate, Best effort, Variable bit rate, and Advanced VBR) that can be selected based on the network environment. This allows maximum performance with regards to image quality, movement, network load, and recorder storage capacity.

## VIQS (Variable Image Quality on Specified Area)

### VIQS

Moving areas that must be monitored are captured at high resolution, and areas where the video remains unchanged are captured at low resolution for reducing the total amount of image data. Up to eight locations can be specified as high-resolution monitoring areas.

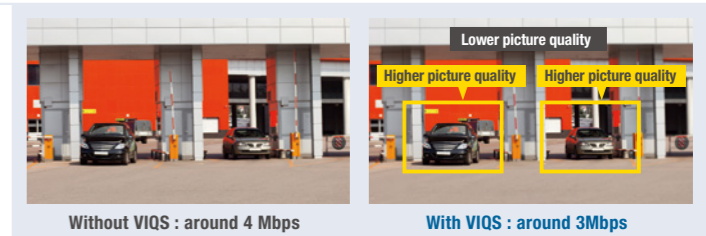

## SD Memory Card Recording

Without using a network, footage can be saved directly to the camera by inserting a SD memory card (SD, SDHC, or SDXC) in the camera.

The WV-SFV631L and other models are equipped with two SD memory card slots for longer recordings. Settings can be adjusted to only record images to the SD memory card when the alarm is triggered. Inserting SD memory cards also works as a backup system when there is an issue with the network. Images will be saved onto the memory cards while the network is down and will be transmitted to the recorder when the network reconnects.



## This is the Panasonic difference!

### Detect Alterations to the SD Memory Card

Turn on the Alteration Detection and record images to the SD memory card to be able to verify whether or not the recorded images have been altered. Playback the images recorded onto the SD memory card with a computer and utilize the Integrity Verifier Tool to analyze the raw data and confirm that the recorded images have not been altered.

Download the Integrity Verifier Tool for free from our "Useful Tool" download page.

<http://security.panasonic.com/download/tools/#iv>

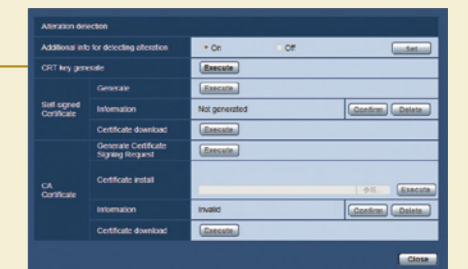

## Security

### HTTPS (SSL)

HTTPS (SSL) can be used to encrypt access to the camera for enhancing communication security.

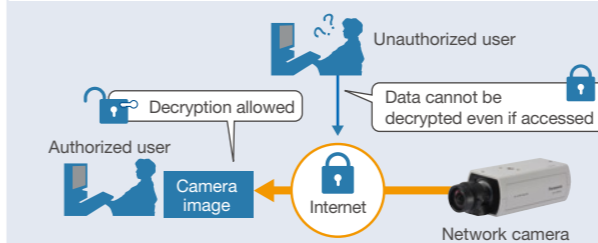

SSL (Secure Socket Layer)... This is a method of encrypting and transmitting data on the network.

### User Authentication

The user access level can be set to one of three levels depending upon the requirement. Digest authentication is also supported, and measures are incorporated to prevent electronic eavesdropping and defacing. If user authentication fails 8 or more times within 30 seconds from a PC with the same IP address, access is temporarily blocked.

### User Access Levels

- Administrator
- Camera control
- Live image display

Priority streams can also be set for specific users so that video can be distributed without lowering the image quality or video update speed, even during simultaneous access by multiple users.



The camera itself features intelligent functionality for notifying the administrator about changes to situations or dangers using a variety of methods. This eliminates the need to constantly watch the screen in the control room for reducing the TCO.

\* Extension software WV-SAE200 is required.

## Intruder Detection



Crossing over the fence



**Detects**  
- the motion of objects in the viewing or detection area.  
Frames and tracks are displayed around the detected moving object in the live image.  
Up to 8 objects can be detected simultaneously.

## Direction Detection \*1



Objects moving in a specified direction



**Detects**  
- objects moving in a specified direction. Up to 8 directions can be specified.  
\*1 Type 1, Type 2, Type 3 network cameras (Refer to the specification pages P.16 - 31) except for WV-SFV481 and WV-SFN480

## Object Detection \*2



Removed Object Detection

Abandoned Object Detection



**Detects**  
- alerts the operator when a left or removed object is detected.  
\*2 Type 2, Type 3 network cameras (Refer to the specification pages P.16 - 31) only

## Loitering Detection



Objects staying longer than a specified time



**Detects**  
- objects loitering for longer than a specified time, from 10 sec to 5 min.

## Scene Change Detection



Interference such as blockage of the lens with a cloth or spray paint

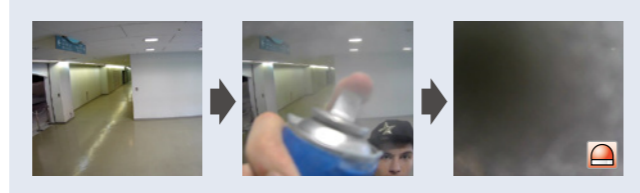

**Detects**  
- interference caused by tampering with the camera, such as a manual change in the camera direction or blockage of the lens with a cloth or spray paint.

## Cross Line Detection \*2



A person who crosses the virtual line to the specified direction

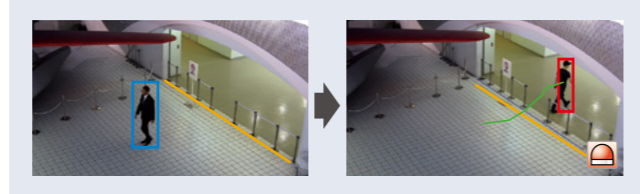

**Detects**  
- alerts the operator when people or objects cross the imaginary lines.  
\*2 Type 2, Type 3 network cameras (Refer to the specification pages P.16 - 31) only

## Actions When an Alarm is Detected

**Monitoring**

Notification sent to the monitoring screen

Alarm notification sent to the recorder and WV-ASM200 management software

Alarm display in WV-ASM200

**Notification sent to device connected to external output**  
Search lights or patrol lights connected to the external output of the camera are lit

**Recorded to the SD memory card installed in the camera**

**Unique alarm notification**  
When a unique alarm (Panasonic alarm protocol) notification is received, the PTZ moves and zooms in on the detection area

**Detection**

Data saved to FTP server





Email notification of alarm

Network Cameras							
PTZ	Outdoor	WV-SUD638(Natural Silver), -H(Gray), -T(Brown)	WV-SW598A	WV-SW397B	WV-SW395	WV-SW395A	P.16 - 17
	Indoor	WV-SC588A	WV-SC387A	WV-SC385	WV-SC384		
Fixed Dome	Outdoor	WV-SFV781L	WV-SFV631LT	WV-SFV631L	WV-SFV611L	WV-SFV531	P.18 - 24
		WV-SFV130	WV-SFV130M	WV-SFV110	WV-SFV110M	WV-SW158	
		WV-SBV131M	WV-SBV111M	WV-SW115			
	Indoor	WV-SFR631L	WV-SFR611L	WV-SFR531	WV-SFR311A	WV-SFR310A	
	WV-SFN531	WV-SFN311L	WV-SFN311A	WV-SFN310A	WV-SFN130	WV-SFN110	WV-SF138
	WV-SF135	WV-SF132					
360-degree Dome	Outdoor	WV-SFV481	WV-SW458	WV-SW458MA			P.25
	Indoor	WV-SFN480	WV-SF448	WV-SF438			
Box / Cylinder	Outdoor	WV-SPV781L	WV-SPW631LT	WV-SPW631L	WV-SPW611L	WV-SPW611	P.26 - 29
		WV-SPW311AL	WV-SPW312L				
	Indoor	WV-SPN631	WV-SPN611	WV-SPN531A	WV-SPN311A	WV-SPN310A	
			WV-SPN531A	WV-SPN311A	WV-SPN310A	WV-SP105	WV-SP102
Pan / Tilt	Outdoor	WV-SW175	WV-SW174W	WV-SW172			P.30 - 31
	Indoor	WV-ST165	WV-ST162	BL-VT164W	BL-VT164		
Optional Accessories Compatibility with Network Cameras							
P.32 - 33							
Application for Smartphone / Tablet PC							
P.34							
IP Migration							
P.35							
Encoder	WJ-GXE500	WJ-GXE100	Coaxial - LAN Converter		WJ-PR204	WJ-PR201	WJ-PC200
Network Video Recorders / Decoder							
P.36 - 37							
Network Disk Recorder	WJ-ND400	WJ-NV300	WJ-NV200	Additional Business Intelligence Kit		WJ-NVF30	WJ-NVF20
Server based recording and video management platform		WV-ASR500 Series	Network Video Decoder		WJ-GXD400		
Network Camera Recorder with Viewer Software		BB-HNP17					
360-degree Network Microphone							
P.37							
Network Microphone	WV-SMR10				Network Microphone with Network Camera		
WV-SMR10N3							
Management Software							
P.38							
IP Matrix Software	WV-ASC970	WV-ASM970					
	• Extension Software	WV-ASE901	WV-ASE902	WV-ASE903			
i-PRO Management Software	WV-ASM200						
	• Extension Software	WV-ASE201	WV-ASE202	WV-ASE203	WV-ASE204	WV-ASE205	
Ethernet System Controller	WV-CU950						
Face Server							
P.39							
Face Recognition System	WV-ASF900 Series						
	• Additional Camera Kit	WV-ASFE901	WV-ASFE904	• Extension Software (for WV-ASM200)		WV-ASE231	



Network Camera Comparison chart





PTZ

Indoor / Outdoor		Outdoor			
Model Name		WV-SUD638(Natural Silver), -H(Gray), -T(Brown)	WV-SW598A	WV-SW397B	WV-SW395 / WV-SW395A
Appearance					
Sensor		1/3 MOS	1/3 MOS	1/3 MOS	1/3 MOS
Codec and Transmission	Video Codec	H.264 / JPEG	H.264 / JPEG	H.264 / JPEG	H.264 / MPEG-4 / JPEG
	H.264 multi stream	4	2	2	2
	JPEG multi stream	3	6	6	6
	H.264 VBR / AVBR (Advanced VBR)	VBR / AVBR	VBR / AVBR	VBR / AVBR	AVBR (V1.80)
	Smart coding	Yes	Yes	Yes	—
Max. Resolution	16 : 9	1920 x 1080	1920 x 1080	1280 x 720	1280 x 720
	4 : 3	1280 x 960	1280 x 960	1280 x 960	1280 x 960
Max. FPS @Max. Resolution	H.264	60fps (1080p)	30fps (1080p)	30fps (1.3 MP)	30fps (1.3 MP)
	JPEG	60fps (1080p)	30fps (1080p)	30fps (1.3 MP)	30fps (1.3 MP)
Super Dynamic / WDR / BLC		Super-D	Super-D	Super-D	Super-D
Day/Night		Yes (ICR)	Yes (ICR)	Yes (ICR)	Yes (ICR)
ABF (Auto Back Focus) / Focus Assist		Auto Focus	Auto Focus	Auto Focus	Auto Focus
Min. Illumination	Color	0.06 lx @F1.6	0.15 lx @F1.6	0.1 lx @F1.6	0.5 lx @F1.6
	Color (Sens up)	0.004 lx (16x)	0.009 lx (16x)	0.007 lx (16x)	0.03 lx (16x)
	B/W	0.02 lx @F1.6	0.018 lx @F1.6	0.013 lx @F1.6	0.06 lx @F1.6
	B/W (Sens up)	0.001 lx (16x)	0.001 lx (16x)	0.001 lx (16x)	0.004 lx (16x)
Lens		f= 4.3 to 129 mm, F1.6 Motorized	f= 4.3 to 129 mm, F1.6	f= 4.3 to 129 mm, F1.6	f= 4.7 to 84.6 mm, F1.6
Angular field of view	16 : 9	H: 2.3 to 64 deg. V: 1.3 to 38 deg.	H: 2.6 to 63 deg. V: 1.5 to 37 deg.	H: 2.6 to 63 deg. V: 1.5 to 37 deg.	H: 3.2 to 55.2 deg. V: 1.9 to 31.9 deg.
	4 : 3	H: 1.8 to 50 deg. V: 1.3 to 38 deg.	H: 1.9 to 46 deg. V: 1.5 to 37 deg.	H: 1.9 to 46 deg. V: 1.5 to 37 deg.	H: 3.2 to 55.2 deg. V: 2.4 to 42.1 deg.
Pan	Range	Endless	Endless	Endless	0 to +350 deg.
	Speed	200 deg/sec	300 deg/sec	300 deg/sec	300 deg/sec
Tilt	Range	Upright : -45° to +90° Forward tilt : -90° to +90° Hanging : +30° to -90°	-15 to +195 deg.	-15 to +195 deg.	-30 to +90 deg.
	Speed	200 deg/sec	300 deg/sec	300 deg/sec	100 deg/sec
360 Pan-Flip		—	—	—	Yes
Number of Preset Positions		256	256	256	64
Patrol		Yes	Yes	Yes	—
Auto Tracking		Yes (advanced)	Yes (advanced)	Yes (advanced)	Yes
Optical Zoom		30x (45x with Extra Zoom at HD)	30x (45x with Extra Zoom at HD)	30x (45x with Extra Zoom at HD)	18x
Digital Zoom		4x	12x	12x	12x
VMD (Video Motion Detection)		Yes (4-areas)	Yes (4-areas)	Yes (4-areas)	Yes (4-areas)
i-VMD (Intelligent VMD) (w/optional extension software)		—	—	—	—
VIQS		Yes (8-areas)	Yes (2-areas)	Yes (2-areas)	—
Max. Connection		14	14	14	14
Audio	In (Line)	Yes	Yes	Yes	Yes
	In (Built-in MIC)	—	—	—	—
	Out	Yes	Yes	Yes	Yes
	Codec	G.711 / G.726 / AAC	G.711 / G.726 / AAC (*1)	G.711 / G.726 / AAC (*1)	G.711 / G.726
Audio Detection Alarm		—	Yes	Yes	—
SD memory Card	Slot	—	Yes (SDXC)	Yes (SDXC)	Yes (SDHC)
	Password & Alter Detection	—	—	—	—
	Audio REC	—	Yes	Yes	—
External I/O		Yes (3) (*2)	Yes (3) (*2)	Yes (3) (*2)	Yes (3) (*2)
Monitor Out		—	Yes (BNC)	Yes (BNC)	Yes (BNC)
Vandal Resistant		IK10	20J, IK10	20J, IK10	20J, IK10
Water and Dust Resistance		IP66 / IP67 / NEMA 4X	IP66 / NEMA 4X	IP66	IP66
Temperature		-50 to +60 deg. (*3) (AC100 to 240 V) -30 to +60 deg. (*3) (PoE) (*4)	-50 to +55 deg. (24 V / 60 W PoE) (*4) -30 to +55 deg. (PoE+)	-50 to +55 deg. (24 V) -30 to +55 deg. (PoE+)	-40 to +50 deg. (24 V) -30 to +50 deg. (PoE+)
Power Source		AC100 to 240 V / PoE Injector	24 V AC / PoE+	24 V AC / PoE+	24 V AC / PoE+
Dehumidification device		Yes	Yes	Yes	Yes
Other Functions		Optional IR LED, Built-in wiper and defroster, ISO14993(Salt damage resistance)	Built-in heater, Rain wash coating, Auto Eyelid Mechanism	Built-in heater, Rain wash coating, Auto Eyelid Mechanism	Built-in heater, Rain wash coating (WV-SW395A)

(\*1): Only for SD REC (\*2): Alarm In1(Day/Night In), Alarm In2(Alarm Out), Alarm In3(AUX Out) (x1 for each) (\*3)Natural Silver model only.Gray & Brown model up to +55deg. (\*4): Tested PoE injector

Network Camera Comparison chart





PTZ

Indoor / Outdoor		Indoor			
Model Name		WV-SC588A	WV-SC387A	WV-SC385	WV-SC384
Appearance					
Sensor		1/3 MOS	1/3 MOS	1/3 MOS	1/3 MOS
Codec and Transmission	Video Codec	H.264 / JPEG	H.264 / JPEG	H.264 / MPEG-4 / JPEG	H.264 / MPEG-4 / JPEG
	H.264 multi stream	2	2	2	2
	JPEG multi stream	6	6	6	6
	H.264 VBR / AVBR (Advanced VBR)	VBR / AVBR	VBR / AVBR	AVBR (V1.80)	AVBR (V1.80)
	Smart coding	Yes	Yes	—	—
Max. Resolution	16 : 9	1920 x 1080	1280 x 720	1280 x 720	1280 x 720
	4 : 3	1280 x 960	1280 x 960	1280 x 960	1280 x 960
Max. FPS @Max. Resolution	H.264	30fps (1080p)	30fps (1.3 MP)	30fps (1.3 MP)	30fps (1.3 MP)
	JPEG	30fps (1080p)	30fps (1.3 MP)	30fps (1.3 MP)	30fps (1.3 MP)
Super Dynamic / WDR / BLC		Super-D	Super-D	Super-D	WDR
Day/Night		Yes (ICR)	Yes (ICR)	Yes (ICR)	Yes (Electrical)
ABF (Auto Back Focus) / Focus Assist		Auto Focus	Auto Focus	Auto Focus	Auto Focus
Min. Illumination	Color	0.15 lx @F1.6	0.1 lx @F1.6	0.5 lx @F1.6	0.6 lx @F1.6
	Color (Sens up)	0.009 lx (16x)	0.007 lx (16x)	0.03 lx (16x)	0.038 lx (16x)
	B/W	0.018 lx @F1.6	0.013 lx @F1.6	0.06 lx @F1.6	0.5 lx @F1.6
	B/W (Sens up)	0.001 lx (16x)	0.001 lx (16x)	0.004 lx (16x)	0.03 lx (16x)
Lens		f= 4.3 to 129 mm, F1.6	f= 4.3 to 129 mm, F1.6	f= 4.7 to 84.6 mm, F1.6	f= 4.7 to 84.6 mm, F1.6
Angular field of view	16 : 9	H: 2.3 to 64 deg. V: 1.3 to 38 deg.	H: 2.3 to 64 deg. V: 1.3 to 38 deg.	H: 3.2 to 55.2 deg. V: 1.9 to 31.9 deg.	H: 3.2 to 55.2 deg. V: 1.9 to 31.9 deg.
	4 : 3	H: 1.7 to 46 deg. V: 1.3 to 38 deg.	H: 1.7 to 46 deg. V: 1.3 to 38 deg.	H: 3.2 to 55.2 deg. V: 2.4 to 42.1 deg.	H: 3.2 to 55.2 deg. V: 2.4 to 42.1 deg.
Pan	Range	Endless	Endless	0 to +350 deg.	0 to +350 deg.
	Speed	300 deg/sec	300 deg/sec	300 deg/sec	300 deg/sec
Tilt	Range	-25 to +205 deg.	-25 to +205 deg.	-30 to +90 deg.	-30 to +90 deg.
	Speed	300 deg/sec	300 deg/sec	100 deg/sec	100 deg/sec
360 Pan-Flip		—	—	Yes	Yes
Number of Preset Positions		256	256	64	64
Patrol		Yes	Yes	—	—
Auto Tracking		Yes (advanced)	Yes (advanced)	Yes	—
Optical Zoom		30x (45x with Extra Zoom at HD)	30x (45x with Extra Zoom at HD)	18x	18x
Digital Zoom		12x	12x	12x	8x
VMD (Video Motion Detection)		Yes (4-areas)	Yes (4-areas)	Yes (4-areas)	Yes (4-areas)
i-VMD (Intelligent VMD) (w/optional extension software)		—	—	—	—
VIQS		Yes (2-areas)	Yes (2-areas)	—	—
Max. Connection		14	14	14	14
Audio	In (Line)	Yes	Yes	Yes	Yes
	In (Built-in MIC)	—	—	—	—
	Out	Yes	Yes	Yes	Yes
	Codec	G.711 / G.726 / AAC (*1)	G.711 / G.726 / AAC (*1)	G.711 / G.726	G.711 / G.726
Audio Detection Alarm		Yes	Yes	—	—
SD memory Card	Slot	Yes (SDXC)	Yes (SDXC)	Yes (SDHC)	Yes (SDHC)
	Password & Alter Detection	—	—	—	—
	Audio REC	Yes	Yes	—	—
External I/O		Yes (3) (*2)	Yes (3) (*2)	Yes (3) (*2)	Yes (3) (*3)
Monitor Out		Yes (mini-jack)	Yes (mini-jack)	Yes (mini-jack)	Yes (mini-jack)
Vandal Resistant		—	—	—	—
Water and Dust Resistance		—	—	—	—
Temperature		-10 to +55 deg.	-10 to +55 deg.	-10 to +50 deg.	-10 to +50 deg.
Power Source		12 V DC / PoE	12 V DC / PoE	12 V DC / PoE	12 V DC / PoE
Dehumidification device		—	—	—	—
Other Functions		Dome less	Dome less	—	—

(\*1): Only for SD REC (\*2): Alarm In1(Day/Night In), Alarm In2(Alarm Out), Alarm In3(AUX Out) (x1 for each) (\*3): Alarm In1, Alarm In2(Alarm Out), Alarm In3(AUX Out) (x1 for each)

Network Camera Comparison chart





Fixed Dome

Indoor / Outdoor		Outdoor				
Model Name		WV-SFV781L	WV-SFV631LT	WV-SFV631L	WV-SFV611L	WV-SFV531
Appearance						
Sensor		1/1.7 MOS	1/3 MOS	1/3 MOS	1/3 MOS	1/3 MOS
Codec and Transmission	Video Codec	H.264 / JPEG	H.264 / JPEG	H.264 / JPEG	H.264 / JPEG	H.264 / JPEG
	H.264 multi stream	4	4	4	4	4
	JPEG multi stream	2	6 (Variable)	6 (Variable)	6 (Variable)	6 (Variable)
	H.264 VBR / AVBR (Advanced VBR)	VBR / AVBR	VBR (V1.52) / AVBR	VBR (V1.52) / AVBR	VBR (V1.52) / AVBR	VBR / AVBR
	Smart coding	Yes	Yes	Yes	Yes	Yes
Max. Resolution	16 : 9	3840 x 2160	1920 x 1080	1920 x 1080	1280 x 720	1920 x 1080
	4 : 3	4000 x 3000	2048 x 1536 (*1)	2048 x 1536 (*1)	1280 x 960	2048 x 1536 (*1)
Max. FPS @Max. Resolution	H.264	30fps (4K)	60fps (1080p)	60fps (1080p)	60fps (720p)	60fps (1080p)
	JPEG	15fps (12 MP)	30fps (3 MP)	30fps (3 MP)	30fps (1.3 MP)	30fps (3 MP)
Super Dynamic / WDR / BLC		WDR	Enhanced SD	Enhanced SD	Enhanced SD	Enhanced SD
Day/Night		Yes (ICR)	Yes (ICR)	Yes (ICR)	Yes (ICR)	Yes (ICR)
ABF (Auto Back Focus) / Focus Assist		ABF	ABF	ABF	ABF	ABF
Min. Illumination	Color	0.3 lx @F1.6	0.06 lx @F1.6	0.04 lx @F1.3	0.01 lx @F1.3	0.07 lx @F1.6
	Color (Sens up)	0.02 lx (16x)	0.0045 lx (16x)	0.003 lx (16x)	0.0007 lx (16x)	0.005 lx (16x)
	B/W	0.0 lx @F1.6 (w/IR)	0.0 lx @F1.6 (w/IR)	0.0 lx @F1.3 (w/IR)	0.0 lx @F1.3 (w/IR)	0.01 lx @F1.6
	B/W (Sens up)	—	—	—	—	0.0007 lx (16x)
Lens		f=4.2 to 25.2 mm, F1.6 Motorized	f= 9 to 22 mm, F1.6 Motorized	f= 2.8 to 10 mm, F1.3 Motorized	f= 2.8 to 10 mm, F1.3 Motorized	f=2.8 to 9.5 mm, F1.6
Angular field of view	16 : 9	H: 17 to 96 deg. V: 9.3 to 54 deg.	H: 13.8 to 33.0 deg. V: 7.7 to 17.8 deg.	H: 28.8 to 102.6 deg. V: 16.0 to 56.0 deg.	H: 26.4 to 93.7 deg. V: 14.8 to 51.6 deg.	H: 31 to 109 deg. V: 18 to 59 deg.
	4 : 3	H: 17 to 100 deg. V: 13 to 75 deg.	H: 11.5 to 27.0 deg. V: 8.6 to 19.9 deg.	H: 23.7 to 84.3 deg. V: 17.8 to 62.4 deg.	H: 26.4 to 93.7 deg. V: 20 to 69.3 deg.	H: 26 to 89 deg. V: 20 to 66 deg.
Adjusting Angle	Pan	-180 to +180 deg.	-180 to +180 deg.	-180 to +180 deg.	-180 to +180 deg.	-180 to +180 deg.
	Tilt	0 to +85 deg.	0 to +85 deg.	0 to +85 deg.	0 to +85 deg.	-85 to +85 deg.
Optical Zoom		6x	2.4x	3.6x	3.6x	3.3x
Digital Zoom		4x	4x	4x	4x	4x
VMD (Video Motion Detection)		Yes (4-areas)	Yes (4-areas)	Yes (4-areas)	Yes (4-areas)	Yes (4-areas)
i-VMD (Intelligent VMD) (w/optional extension software)		—	Yes (Type2)	Yes (Type2)	Yes (Type2)	Yes (Type2)
VIQS		Yes (8-areas)	Yes (8-areas)	Yes (8-areas)	Yes (8-areas)	Yes (8-areas)
Max. Connection		14	14	14	14	14
Audio	In (Line)	Yes	Yes	Yes	Yes	Yes
	In (Built-in MIC)	—	—	—	—	—
	Out	Yes	Yes	Yes	Yes	Yes
	Codec	G.711 / G.726 / AAC (*2)	G.711 / G.726 / AAC	G.711 / G.726 / AAC	G.711 / G.726 / AAC	G.711 / G.726 / AAC
	Audio Detection Alarm	—	Yes	Yes	Yes	Yes
SD memory Card	Slot	Yes (SDXC)	Yes (SDXC x 2)	Yes (SDXC x 2)	Yes (SDXC x 2)	Yes (SDXC)
	Password & Alter Detection	—	Yes (V1.52)	Yes (V1.52)	Yes (V1.52)	Yes
	Audio REC	Yes	Yes	Yes	Yes	Yes
External I/O		Yes (3) (*3)	Yes (3) (*4)	Yes (3) (*4)	Yes (3) (*4)	Yes (3) (*4)
Monitor Out		Yes (RCA)	Yes (mini jack)	Yes (mini jack)	Yes (mini jack)	Yes (mini jack)
Vandal Resistant		20J, IK10	50J, IK10	50J, IK10	50J, IK10	50J, IK10
Water and Dust Resistance		IP66 / NEMA 4X	IP66 / NEMA 4X	IP66 / NEMA 4X	IP66 / NEMA 4X	IP66 / NEMA 4X
Temperature		-45 to +50 deg.	-45 to +50 deg.	-45 to +50 deg.	-45 to +50 deg.	-40 to +50 deg.
Power Source		12 V DC / PoE	12 V DC / PoE	12 V DC / PoE	12 V DC / PoE	12 V DC / PoE
Dehumidification device		Yes	Yes	Yes	Yes	Yes
Other Functions		Built-in heater, Rain wash coating, Built-in IR LED	Smart-DoF, Built-in heater, Built-in IR LED	Smart-DoF, Built-in heater, Built-in IR LED	Smart-DoF, Built-in heater, Built-in IR LED	Built-in heater

(\*1): w/Super resolution (\*2): Only for SD REC (\*3): Alarm In1(Day/Night In), Alarm In2(Alarm Out), Alarm In3(AUX Out, Day/Night Out) (x1 for each) (\*4): Alarm In1(Day/Night In), Alarm In2(Alarm Out), Alarm In3(AUX Out) (x1 for each)

Network Camera Comparison chart





Fixed Dome

Indoor / Outdoor		Outdoor			
Model Name		WV-SFV311A	WV-SFV310A	WV-SFV130 / WV-SFV130M	WV-SFV110 / WV-SFV110M
Appearance					
Sensor		1/3 MOS	1/3 MOS	1/3 MOS	1/3 MOS
Codec and Transmission	Video Codec	H.264 / JPEG	H.264 / JPEG	H.264 / JPEG	H.264 / JPEG
	H.264 multi stream	4	4	4	4
	JPEG multi stream	6 (Variable)	6 (Variable)	6 (Variable)	6 (Variable)
	H.264 VBR / AVBR (Advanced VBR)	VBR / AVBR	VBR / AVBR	VBR / AVBR	VBR / AVBR
	Smart coding	Yes	Yes	Yes	Yes
Max. Resolution	16 : 9	1920 x 1080 (*1) / 1280 x 720	1920 x 1080 (*1) / 1280 x 720	1920 x 1080	1280 x 720
	4 : 3	1280 x 960	1280 x 960	2048 x 1536 (*1)	1280 x 960
Max. FPS @Max. Resolution	H.264	60fps (720p)	60fps (720p)	30fps (1080p)	30fps (720p)
	JPEG	30fps (1.3 MP)	30fps (1.3 MP)	30fps (1080p)	30fps (720p)
Super Dynamic / WDR / BLC		Enhanced SD	Enhanced SD	Super-D	Super-D
Day/Night		Yes (ICR)	Yes (Electrical)	Yes (Electrical)	Yes (Electrical)
ABF (Auto Back Focus) / Focus Assist		ABF	ABF	—	—
Min. Illumination	Color	0.01 lx @F1.6	0.01 lx @F1.6	0.1 lx @F2.3	0.04 lx @F2.3
	Color (Sens up)	0.0007 lx (16x)	0.0007 lx (16x)	0.007 lx (16x)	0.003 lx (16x)
	B/W	0.003 lx @F1.6	0.008 lx @F1.6	0.08 lx @F2.3	0.03 lx @F2.3
	B/W (Sens up)	0.0002 lx (16x)	0.0005 lx (16x)	0.005 lx (16x)	0.002 lx (16x)
Lens		f= 2.8 to 10 mm, F1.6	f= 2.8 to 10 mm, F1.6	f= 2.8 mm, F2.3	f= 2.8 mm, F2.3
Angular field of view	16 : 9	H: 28 to 99 deg. V: 16 to 54 deg.	H: 28 to 99 deg. V: 16 to 54 deg.	H: 108 deg. V: 60 deg.	H: 100 deg. V: 55 deg.
	4 : 3	H: 28 to 99 deg. V: 21 to 72 deg.	H: 28 to 99 deg. V: 21 to 72 deg.	H: 89 deg. V: 66 deg.	H: 100 deg. V: 73 deg.
Adjusting Angle	Pan	-180 to +180 deg.	-180 to +180 deg.	-20 to +20 deg.	-20 to +20 deg.
	Tilt	-85 to +85 deg.	-85 to +85 deg.	-20 to +90 deg.	-20 to +90 deg.
Optical Zoom		3.6x	3.6x	—	—
Digital Zoom		4x	4x	4x	4x
VMD (Video Motion Detection)		Yes (4-areas)	Yes (4-areas)	Yes (4-areas)	Yes (4-areas)
i-VMD (Intelligent VMD) (w/optional extension software)		Yes (Type2)	Yes (Type2)	Yes (Type2)	Yes (Type2)
VIQS		Yes (8-areas)	Yes (8-areas)	Yes (8-areas)	Yes (8-areas)
Max. Connection		14	14	14	14
Audio	In (Line)	Yes	—	—	—
	In (Built-in MIC)	—	—	Yes	Yes
	Out	Yes	—	—	—
	Codec	G.711 / G.726 / AAC	—	G.711 / G.726 / AAC (*2)	G.711 / G.726 / AAC (*2)
	Audio Detection Alarm	Yes	—	—	—
SD memory Card	Slot	Yes (SDXC)	Yes (SDXC)	Yes (SDXC)	Yes (SDXC)
	Password & Alter Detection	Yes	Yes	Yes	Yes
	Audio REC	Yes	—	Yes	Yes
External I/O		Yes (3) (*3)	Yes (3) (*4)	—	—
Monitor Out		Yes (mini jack)	Yes (mini jack)	—	—
Vandal Resistant		50J, IK10	50J, IK10	50J, IK10	50J, IK10
Water and Dust Resistance		IP66 / NEMA 4X	IP66 / NEMA 4X	IP66 / NEMA 4X	IP66 / NEMA 4X
Temperature		-40 to +50 deg. (in operation)	-40 to +50 deg. (in operation)	-40 to +60 deg.	-40 to +60 deg.
Power Source		12 V DC / PoE	12 V DC / PoE	PoE	PoE
Dehumidification device		Yes	Yes	—	—
Other Functions		Built-in heater	Built-in heater	EN50155-T3, EN50121, EN45545, EN50498, ECE-R10(WV-SFV130M)	EN50155-T3, EN50121, EN45545, EN50498, ECE-R10(WV-SFV110M)

(\*1): w/Super resolution (\*2): Only for SD REC (\*3): Alarm In1 (Day/Night In, Auto time adjustment), Alarm In 2 (Alarm Out), Alarm In 3 (AUX Out) (x1 for each) (\*4): Alarm In1 (Auto time adjustment), Alarm In 2 (Alarm Out), Alarm In 3 (AUX Out) (x1 for each)

Network Camera Comparison chart





Fixed Dome

Indoor / Outdoor		Outdoor			
Model Name		WV-SW158	WV-SW155 / WV-SW155MA(*1)	WV-SBV131M	WV-SBV111M
Appearance					
Sensor		1/3 MOS	1/3 MOS	1/3 MOS	1/3 MOS
Codec and Transmission	Video Codec	H.264 / JPEG	H.264 / JPEG	H.264 / JPEG	H.264 / JPEG
	H.264 multi stream	2	2	4	4
	JPEG multi stream	6	6	6(Variable)	6(Variable)
	H.264 VBR / AVBR (Advanced VBR)	VBR / AVBR (V1.90)	VBR / AVBR (V2.20)	VBR / AVBR	VBR / AVBR
	Smart coding	—	—	Yes	Yes
Max. Resolution	16 : 9	1920 x 1080	1280 x 720	1920 x 1080	1280 x 720
	4 : 3	H.264: 1280 x 960 JPEG : 2048 x 1536	1280 x 960	2048 x 1536 (*2)	1280 x 960
Max. FPS @Max. Resolution	H.264	30fps (1080p + 360p)	30fps (1.3 MP)	30fps (1080p)	30fps (720p)
	JPEG	30fps (1080p)	30fps (1.3 MP)	30fps (3 MP)	30fps (1.3 MP)
Super Dynamic / WDR / BLC		Super-D	Super-D	WDR	WDR
Day/Night		Yes (Electrical)	Yes (Electrical)	Yes (Electrical)	Yes (Electrical)
ABF (Auto Back Focus) / Focus Assist		—	—	—	—
Min. Illumination	Color	1.2 lx @F2.2	0.8 lx @F2.2	0.1 lx @F2.2	0.04 lx @F2.2
	Color (Sens up)	0.075 lx (16x)	0.05 lx (16x)	0.007 lx (16x)	0.003 lx (16x)
	B/W	0.9 lx @F2.2	0.6 lx @F2.2	0.06 lx @F2.2	0.03 lx @F2.2
	B/W (Sens up)	0.056 lx (16x)	0.04 lx (16x)	0.004 lx (16x)	0.002 lx (16x)
Lens		f= 1.95 mm, F2.2	f= 1.95 mm, F2.2	f= 1.95 mm, F2.2	f= 1.95 mm, F2.2
Angular field of view	16 : 9	H: 95 deg. V: 62 deg.	H: 104 deg. V: 68 deg.	H: 109 deg. V: 73 deg.	H: 104 deg. V: 69 deg.
	4 : 3	H: 100 deg. V: 81 deg.	H: 104 deg. V: 85 deg.	H: 97 deg. V: 79 deg.	H: 104 deg. V: 85 deg.
Adjusting Angle	Pan	-20 to +20 deg.	-20 to +20 deg.	-170 to +170 deg.	-170 to +170 deg.
	Tilt	-20 to +90 deg.	-20 to +90 deg.	-90 to +90 deg.	-90 to +90 deg.
Optical Zoom		—	—	—	—
Digital Zoom		4x	4x	4x	4x
VMD (Video Motion Detection)		Yes (4-areas)	Yes	Yes (4-areas)	Yes (4-areas)
i-VMD (Intelligent VMD) (w/optional extension software)		Yes (Type1)	—	—	—
VIQS		Yes (2-areas)	Yes (1-area)	Yes (8-areas)	Yes (8-areas)
Max. Connection		14	14	14	14
Audio	In (Line)	—	—	Yes	Yes
	In (Built-in MIC)	Yes	—	—	—
	Out	—	—	Yes	Yes
	Codec	G.711 / G.726 / AAC	—	G.726(ADPCM)	G.726(ADPCM)
	Audio Detection Alarm	Yes	—	—	—
SD memory Card	Slot	Yes (SDXC)	Yes (SDHC)	Yes (SDXC)	Yes (SDXC)
	Password & Alter Detection	—	—	—	—
	Audio REC	Yes	—	—	—
External I/O		—	—	—	—
Monitor Out		—	—	—	—
Vandal Resistant		50J, IK10	50J, IK10	IK10	IK10
Water and Dust Resistance		IP66 / NEMA 4X	IP66 / NEMA 4X	IP6K9K / IP66 / NEMA 4X	IP6K9K / IP66 / NEMA 4X
Temperature		-30 to +50 deg.	-30 to +50 deg.	-40 to +60 deg.	-40 to +60 deg.
Power Source		PoE	PoE	PoE	PoE
Dehumidification device		—	—	—	—
Other Functions		EN50155-T3, EN50121, EN45545, DIN5510	EN50155-T3, EN50121, EN45545, DIN5510, ECE-R10(WV-SW155MA)	MIL-STD-810G, EN50155-T3, EN50121, EN45545, EN50498, ECE-R10	MIL-STD-810G, EN50155-T3, EN50121, EN45545, EN50498, ECE-R10

(\*1): WV-SW155 : 10BASE-T/100BASE-TX, RJ45 connector / WV-SW155MA : 10BASE-T/100BASE-TX, M12 connector (\*2): with Simple Full-HD mode (tentative name)

Network Camera Comparison chart





Fixed Dome

Indoor / Outdoor		Outdoor	Indoor		
Model Name		WV-SW115	WV-SFR631L	WV-SFR611L	WV-SFR531
Appearance					
Sensor		1/3 MOS	1/3 MOS	1/3 MOS	1/3 MOS
Codec and Transmission	Video Codec	H.264 / JPEG	H.264 / JPEG	H.264 / JPEG	H.264 / JPEG
	H.264 multi stream	2	4	4	4
	JPEG multi stream	6	6 (Variable)	6 (Variable)	6 (Variable)
	H.264 VBR / AVBR (Advanced VBR)	AVBR	VBR (V1.52) / AVBR	VBR (V1.52) / AVBR	VBR / AVBR
	Smart coding	—	Yes	Yes	Yes
Max. Resolution	16 : 9	1280 x 720	1920 x 1080	1280 x 720	1920 x 1080
	4 : 3	1280 x 960	2048 x 1536 (*1)	1280 x 960	2048 x 1536 (*1)
Max. FPS @Max. Resolution	H.264	30fps (1.3 MP)	60fps (1080p)	60fps (720p)	60fps (1080p)
	JPEG	30fps (1.3 MP)	30fps (3 MP) (*1)	30fps (1.3 MP)	30fps (3 MP) (*1)
Super Dynamic / WDR / BLC		Super-D	Enhanced SD	Enhanced SD	Enhanced SD
Day/Night		Yes (Electrical)	Yes (ICR)	Yes (ICR)	Yes (ICR)
ABF (Auto Back Focus) / Focus Assist		—	ABF	ABF	ABF
Min. Illumination	Color	0.8 lx @F2.2	0.04 lx @F1.3	0.01 lx @F1.3	0.07 lx @F1.6
	Color (Sens up)	0.05 lx (16x)	0.003 lx (16x)	0.0007 lx (16x)	0.005 lx (16x)
	B/W	0.6 lx @F2.2	0.0 lx @F1.3(w/IR)	0.0 lx @F1.3(w/IR)	0.01 lx @F1.6
	B/W (Sens up)	0.04 lx (16x)	—	—	0.0007 lx (16x)
Lens		f= 1.95 mm, F2.2	f= 2.8 to 10 mm, F1.3 Motorized	f= 2.8 to 10 mm, F1.3 Motorized	f=2.8 to 9.5 mm, F1.6
Angular field of view	16 : 9	H: 104 deg. V: 68 deg.	H: 28.8 to 102.9 deg. V: 16.0 to 56.2 deg.	H: 26.4 to 94.0 deg. V: 14.7 to 51.8 deg.	H: 31 to 109 deg. V: 18 to 59 deg.
	4 : 3	H: 104 deg. V: 85 deg.	H: 23.8 to 84.6 deg. V: 17.8 to 62.6 deg.	H: 26.4 to 94.0 deg. V: 19.8 to 69.5 deg.	H: 26 to 89 deg. V: 20 to 66 deg.
Adjusting Angle	Pan	-30 to +30 deg.	-180 to +180 deg.	-180 to +180 deg.	+120(right) to -240(left) deg.
	Tilt	-30 to +30 deg.	0 to +85 deg.	0 to +85 deg.	-85 to +85 deg.
Optical Zoom		—	3.6x	3.6x	3.3x
Digital Zoom		4x	4x	4x	4x
VMD (Video Motion Detection)		Yes	Yes (4-areas)	Yes (4-areas)	Yes (4-areas)
i-VMD (Intelligent VMD) (w/optional extension software)		—	Yes (Type2)	Yes (Type2)	Yes (Type2)
VIQS		Yes (1-area)	Yes (8-areas)	Yes (8-areas)	Yes (8-areas)
Max. Connection		14	14	14	14
Audio	In (Line)	—	Yes	Yes	Yes
	In (Built-in MIC)	—	—	—	—
	Out	—	Yes	Yes	Yes
	Codec	—	G.711 / G.726 / AAC	G.711 / G.726 / AAC	G.711 / G.726 / AAC
	Audio Detection Alarm	—	Yes	Yes	Yes
SD memory Card	Slot	Yes (SDHC)	Yes (SDXC x 2)	Yes (SDXC x 2)	Yes (SDXC)
	Password & Alter Detection	—	Yes (V1.52)	Yes (V1.52)	Yes
	Audio REC	—	Yes	Yes	Yes
External I/O		—	Yes (3) (*2)	Yes (3) (*2)	Yes (3) (*3)
Monitor Out		—	Yes (mini jack)	Yes (mini jack)	Yes (mini jack)
Vandal Resistant		20J, IK10	20J, IK10	20J, IK10	20J, IK10
Water and Dust Resistance		IP66 / NEMA 4X	—	—	—
Temperature		-30 to +50 deg.	-10 to +50 deg.	-10 to +50 deg.	-10 to +50 deg.
Power Source		PoE	12 V DC / PoE	12 V DC / PoE	12 V DC / PoE
Dehumidification device		—	—	—	—
Other Functions		EN50155, EN50121	Smart-DoF, Built-in IR LED	Smart-DoF, Built-in IR LED	—

(\*1): w/Super resolution (\*2): Alarm In1(Day/Night In), Alarm In2(Alarm Out), Alarm In3(AUX Out) (x1 for each) (\*3): Alarm In1, Alarm In2(Alarm Out), Alarm In3(AUX Out) (x1 for each)

Network Camera Comparison chart





Fixed Dome

Indoor / Outdoor		Indoor			
Model Name		WV-SFR311A	WV-SFR310A	WV-SFN631L	WV-SFN611L
Appearance					
Sensor		1/3 MOS	1/3 MOS	1/3 MOS	1/3 MOS
Codec and Transmission	Video Codec	H.264 / JPEG	H.264 / JPEG	H.264 / JPEG	H.264 / JPEG
	H.264 multi stream	4	4	4	4
	JPEG multi stream	6 (Variable)	6 (Variable)	6 (Variable)	6 (Variable)
	H.264 VBR / AVBR (Advanced VBR)	VBR / AVBR	VBR / AVBR	VBR (V1.52) / AVBR	VBR (V1.52) / AVBR
	Smart coding	Yes	Yes	Yes	Yes
Max. Resolution	16 : 9	1920 x 1080 (*1) / 1280 x 720	1920 x 1080 (*1) / 1280 x 720	1920 x 1080	1280 x 720
	4 : 3	1280 x 960	1280 x 960	2048 x 1536 (*1)	1280 x 960
Max. FPS @Max. Resolution	H.264	60fps (720p)	60fps (720p)	60fps (1080p)	60fps (720p)
	JPEG	30fps (1.3 MP)	30fps (1.3 MP)	30fps (3 MP) (*1)	30fps (1.3 MP)
Super Dynamic / WDR / BLC		Enhanced SD	Enhanced SD	Enhanced SD	Enhanced SD
Day/Night		Yes (ICR)	Yes (Electrical)	Yes (ICR)	Yes (ICR)
ABF (Auto Back Focus) / Focus Assist		ABF	ABF	ABF	ABF
Min. Illumination	Color	0.01 lx @F1.6	0.01 lx @F1.6	0.04 lx @F1.3	0.01 lx @F1.3
	Color (Sens up)	0.0007 lx (16x)	0.0007 lx (16x)	0.003 lx (16x)	0.0007 lx (16x)
	B/W	0.003 lx @F1.6	0.008 lx @F1.6	0.0 lx @F1.3 (w/IR)	0.0 lx @F1.3 (w/IR)
	B/W (Sens up)	0.0002 lx (16x)	0.0005 lx (16x)	—	—
Lens		f= 2.8 to 10 mm, F1.6	f= 2.8 to 10 mm, F1.6	f= 2.8 to 10 mm, F1.3 Motorized	f= 2.8 to 10 mm, F1.3 Motorized
Angular field of view	16 : 9	H: 28 to 99 deg. V: 16 to 54 deg.	H: 28 to 99 deg. V: 16 to 54 deg.	H: 29.3 to 104.1 deg. V: 16.2 to 56.8 deg.	H: 26.6 to 95.1 deg. V: 14.9 to 52.3 deg.
	4 : 3	H: 28 to 99 deg. V: 21 to 72 deg.	H: 28 to 99 deg. V: 21 to 72 deg.	H: 24.0 to 85.5 deg. V: 18.0 to 63.3 deg.	H: 26.7 to 95.1 deg. V: 20.0 to 70.2 deg.
Adjusting Angle	Pan	+120 to -240 deg.	+120 to -240 deg.	-180 to +180 deg.	-180 to +180 deg.
	Tilt	-85 to +85 deg.	-85 to +85 deg.	0 to +85 deg.	0 to +85 deg.
Optical Zoom		3.6x	3.6x	3.6x	3.6x
Digital Zoom		4x	4x	4x	4x
VMD (Video Motion Detection)		Yes (4-areas)	Yes (4-areas)	Yes (4-areas)	Yes (4-areas)
i-VMD (Intelligent VMD) (w/optional extension software)		Yes (Type2)	Yes (Type2)	Yes (Type2)	Yes (Type2)
VIQS		Yes (8-areas)	Yes (8-areas)	Yes (8-areas)	Yes (8-areas)
Max. Connection		14	14	14	14
Audio	In (Line)	Yes	—	Yes	Yes
	In (Built-in MIC)	—	—	—	—
	Out	Yes	—	Yes	Yes
	Codec	G.711 / G.726 / AAC	—	G.711 / G.726 / AAC	G.711 / G.726 / AAC
	Audio Detection Alarm	Yes	—	Yes	Yes
SD memory Card	Slot	Yes (SDXC)	Yes (SDXC)	Yes (SDXC x 2)	Yes (SDXC x 2)
	Password & Alter Detection	Yes	Yes	Yes (V1.52)	Yes (V1.52)
	Audio REC	Yes	—	Yes	Yes
External I/O		Yes (3) (*2)	Yes (3) (*3)	Yes (3) (*4)	Yes (3) (*5)
Monitor Out		Yes (mini jack)	Yes (mini jack)	Yes (mini jack)	Yes (mini jack)
Vandal Resistant		20J, IK10	20J, IK10	—	—
Water and Dust Resistance		—	—	—	—
Temperature		-10 to +50 deg.	-10 to +50 deg.	-10 to +50 deg.	-10 to +50 deg.
Power Source		12 V DC / PoE	12 V DC / PoE	12 V DC / PoE	12 V DC / PoE
Dehumidification device		—	—	—	—
Other Functions		—	—	Smart-DoF, Built-in IR LED	Smart-DoF, Built-in IR LED

(\*1): w/Super resolution (\*2): Alarm In1 (Day/Night In, Auto time adjustment), Alarm In 2 (Alarm Out), Alarm In 3 (AUX Out) (x1 for each) (\*3): Alarm In1 (Auto time adjustment), Alarm In 2 (Alarm Out), Alarm In 3 (AUX Out) (x1 for each) (\*4): Alarm In1(Day/Night In), Alarm In2(Alarm Out), Alarm In3(AUX Out) (x1 for each) (\*5): Alarm In1, Alarm In2(Alarm Out), Alarm In3(AUX Out) (x1 for each)

Network Camera Comparison chart











Fixed Dome

Indoor / Outdoor		Indoor			
Model Name		WV-SFN531	WV-SFN311L	WV-SFN311A	WV-SFN310A
Appearance					
Sensor		1/3 MOS	1/3 MOS	1/3 MOS	1/3 MOS
Codec and Transmission	Video Codec	H.264 / JPEG	H.264 / JPEG	H.264 / JPEG	H.264 / JPEG
	H.264 multi stream	4	4	4	4
	JPEG multi stream	6 (Variable)	6 (Variable)	6 (Variable)	6 (Variable)
	H.264 VBR / AVBR (Advanced VBR)	VBR / AVBR	VBR / AVBR	VBR / AVBR	VBR / AVBR
	Smart coding	Yes	Yes	Yes	Yes
Max. Resolution	16 : 9	1920 x 1080	1280 x 720	1920 x 1080 (*1) / 1280 x 720	1920 x 1080 (*1) / 1280 x 720
	4 : 3	2048 x 1536 (*1)	1280 x 960	1280 x 960	1280 x 960
Max. FPS @Max. Resolution	H.264	60fps (1080p)	60fps (720p)	60fps (720p)	60fps (720p)
	JPEG	30fps (3 MP) (*1)	30fps (1.3 MP)	30fps (1.3 MP)	30fps (1.3 MP)
Super Dynamic / WDR / BLC		Enhanced SD	Enhanced SD	Enhanced SD	Enhanced SD
Day/Night		Yes (ICR)	Yes (ICR)	Yes (ICR)	Yes (Electrical)
ABF (Auto Back Focus) / Focus Assist		ABF	ABF	ABF	ABF
Min. Illumination	Color	0.07 lx @F1.6	0.01 lx @F1.6	0.01 lx @F1.6	0.01 lx @F1.6
	Color (Sens up)	0.005 lx (16x)	0.0007 lx (16x)	0.0007 lx (16x)	0.0007 lx (16x)
	B/W	0.01 lx @F1.6	0.0 lx @F1.6 (w/IR)	0.003 lx @F1.6	0.008 lx @F1.6
	B/W (Sens up)	0.0007 lx (16x)	—	0.0002 lx (16x)	0.0005 lx (16x)
Lens		f=2.8 to 9.5 mm, F1.6	f= 2.8 to 10 mm, F1.6	f= 2.8 to 10 mm, F1.6	f= 2.8 to 10 mm, F1.6
Angular field of view	16 : 9	H: 32 to 110 deg. V: 18 to 60 deg.	H: 27.9 to 100.5 deg. V: 15.7 to 54.8 deg.	H: 28 to 100 deg. V: 16 to 54 deg.	H: 28 to 100 deg. V: 16 to 54 deg.
	4 : 3	H: 27 to 91 deg. V: 20 to 66 deg.	H: 27.9 to 100.0 deg. V: 21.0 to 73.9 deg.	H: 28 to 100 deg. V: 21 to 73 deg.	H: 28 to 100 deg. V: 21 to 73 deg.
Adjusting Angle	Pan	+120(right) to -240(left) deg.	-180 to +180 deg.	+120 to -240 deg.	+120 to -240 deg.
	Tilt	-85 to +85 deg.	0 to +85 deg.	-85 to +85 deg.	-85 to +85 deg.
Optical Zoom		3.3x	3.6x	3.6x	3.6x
Digital Zoom		4x	4x	4x	4x
VMD (Video Motion Detection)		Yes (4-areas)	Yes (4-areas)	Yes (4-areas)	Yes (4-areas)
i-VMD (Intelligent VMD) (w/optional extension software)		Yes (Type2)	Yes (Type2)	Yes (Type2)	Yes (Type2)
VIQS		Yes (8-areas)	Yes (8-areas)	Yes (8-areas)	Yes (8-areas)
Max. Connection		14	14	14	14
Audio	In (Line)	Yes	Yes	Yes	—
	In (Built-in MIC)	—	—	—	Yes
	Out	Yes	Yes	Yes	—
	Codec	G.711 / G.726 / AAC	G.711 / G.726 / AAC	G.711 / G.726 / AAC	G.711 / G.726 / AAC
	Audio Detection Alarm	Yes	Yes	Yes	Yes
SD memory Card	Slot	Yes (SDXC)	Yes (SDXC)	Yes (SDXC)	Yes (SDXC)
	Password & Alter Detection	Yes	Yes	Yes	Yes
	Audio REC	Yes	Yes	Yes	Yes
External I/O		Yes (3) (*2)	Yes (3) (*2)	Yes (3) (*3)	Yes (3) (*4)
Monitor Out		Yes (mini jack)	Yes (mini jack)	Yes (mini jack)	Yes (mini jack)
Vandal Resistant		—	—	—	—
Water and Dust Resistance		—	—	—	—
Temperature		-10 to +50 deg.	-10 to +50 deg.	-10 to +50 deg.	-10 to +50 deg.
Power Source		12 V DC / PoE	12 V DC / PoE	12 V DC / PoE	12 V DC / PoE
Dehumidification device		—	—	—	—
Other Functions		—	Built-in IR LED	—	—

(\*1): w/Super resolution (\*2): Alarm In1(Day/Night In), Alarm In2(Alarm Out), Alarm In3(AUX Out) (x1 for each) (\*3): Alarm In1 (Day/Night In, Auto time adjustment), Alarm In 2 (Alarm Out), Alarm In 3 (AUX Out) (x1 for each) (\*4): Alarm In1 (Auto time adjustment), Alarm In 2 (Alarm Out), Alarm In 3 (AUX Out) (x1 for each)

## Network Camera Comparison chart











## Fixed Dome

Indoor / Outdoor		Indoor				
Model Name		WV-SFN130	WV-SFN110	WV-SF138	WV-SF135	WV-SF132
Appearance						
						
Sensor		1/3 MOS	1/3 MOS	1/3 MOS	1/3 MOS	1/5 MOS
Codec and Transmission	Video Codec	H.264 / JPEG	H.264 / JPEG	H.264 / JPEG	H.264 / JPEG	H.264 / JPEG
	H.264 multi stream	4	4	2	2	2
	JPEG multi stream	6 (Variable)	6 (Variable)	6	6	6
	H.264 VBR / AVBR (Advanced VBR)	VBR / AVBR	VBR / AVBR	VBR / AVBR (V1.90)	AVBR (V1.80)	AVBR (V1.80)
	Smart coding	Yes	Yes	—	—	—
Max. Resolution	16 : 9	1920 x 1080	1280 x 720	1920 x 1080	1280 x 720	640 x 360
	4 : 3	2048 x 1536 (*1)	1280 x 960	H.264: 1280 x 960 JPEG : 2048 x 1536	1280 x 960	640 x 480
Max. FPS @Max. Resolution	H.264	30fps (1080p)	30fps (720p)	30fps (1080p + 360p)	30fps (1.3 MP)	30fps (VGA)
	JPEG	30fps (1080p)	30fps (720p)	30fps (1080p)	30fps (1.3 MP)	30fps (VGA)
Super Dynamic / WDR / BLC		Super-D	Super-D	Super-D	BLC	BLC
Day/Night		Yes (Electrical)	Yes (Electrical)	Yes (Electrical)	Yes (Electrical)	Yes (Electrical)
ABF (Auto Back Focus) / Focus Assist		—	—	—	—	—
Min. Illumination	Color	0.1 lx @F2.3	0.04 lx @F2.3	1.2 lx @F2.2	0.8 lx @F2.2	2.0 lx @F2.9
	Color (Sens up)	0.007 lx (16x)	0.003 lx (16x)	0.075 lx (16x)	0.05 lx (16x)	0.3 lx (16x)
	B/W	0.08 lx @F2.3	0.03 lx @F2.3	0.9 lx @F2.2	0.6 lx @F2.2	1.3 lx @F2.9
	B/W (Sens up)	0.005 lx (16x)	0.002 lx (16x)	0.056 lx (16x)	0.04 lx (16x)	0.16 lx (16x)
Lens		f= 2.8 mm, F2.3	f= 2.8 mm, F2.3	f= 1.95 mm, F2.2	f= 1.95 mm, F2.2	f= 1.95 mm, F2.9
Angular field of view	16 : 9	H: 108 deg. V: 60 deg.	H: 100 deg. V: 55 deg.	H: 95 deg. V: 62 deg.	H: 104 deg. V: 68 deg.	H: 104 deg. V: 68 deg.
	4 : 3	H: 89 deg. V: 66 deg.	H: 100 deg. V: 73 deg.	H: 100 deg. V: 81 deg.	H: 104 deg. V: 85 deg.	H: 68 deg. V: 53 deg.
Adjusting Angle	Pan	-20 to +20 deg.	-20 to +20 deg.	-20 to +20 deg.	-20 to +20 deg.	-20 to +20 deg.
	Tilt	-20 to +90 deg.	-20 to +90 deg.	-20 to +90 deg.	-20 to +90 deg.	-20 to +90 deg.
Optical Zoom		—	—	—	—	—
Digital Zoom		4x	4x	4x	4x	4x
VMD (Video Motion Detection)		Yes (4-areas)	Yes (4-areas)	Yes (4-areas)	Yes	Yes
i-VMD (Intelligent VMD) (w/optional extension software)		Yes (Type2)	Yes (Type2)	Yes (Type1)	—	—
VIQS		Yes (8-areas)	Yes (8-areas)	Yes (2-areas)	Yes (1-area)	Yes (1-area)
Max. Connection		14	14	14	14	14
Audio	In (Line)	—	—	—	—	—
	In (Built-in MIC)	Yes	Yes	Yes	—	—
	Out	—	—	—	—	—
	Codec	G.711 / G.726 / AAC (*2)	G.711 / G.726 / AAC (*2)	G.711 / G.726 / AAC	—	—
	Audio Detection Alarm	Yes	Yes	Yes	—	—
SD memory Card	Slot	Yes (SDXC)	Yes (SDXC)	Yes (SDXC)	—	—
	Password & Alter Detection	Yes	Yes	—	—	—
	Audio REC	Yes	Yes	Yes	—	—
External I/O		—	—	—	—	—
Monitor Out		—	—	—	—	—
Vandal Resistant		—	—	—	—	—
Water and Dust Resistance		—	—	—	—	—
Temperature		0 to +40 deg.	0 to +40 deg.	0 to +40 deg.	0 to +40 deg.	0 to +40 deg.
Power Source		PoE	PoE	PoE	PoE	PoE
Dehumidification device		—	—	—	—	—
Other Functions		—	—	—	—	—

(\*1): w/Super resolution (\*2): Only for SD REC





## Network Camera Comparison chart

## 360-degree Dome

Indoor / Outdoor		Outdoor		Indoor		
Model Name		WV-SFV481	WV-SW458 / WV-SW458MA(*1)	WV-SFN480	WV-SF448	WV-SF438
Appearance						
						
Sensor		1/2 MOS	1/3 MOS	1/2 MOS	1/3 MOS	1/3 MOS
Codec and Transmission	Video Codec	H.264 / JPEG	H.264 / JPEG	H.264 / JPEG	H.264 / JPEG	H.264 / JPEG
	H.264 multi stream	2	2	2	2	2
	JPEG multi stream	2	6	2	6	6
	H.264 VBR / AVBR (Advanced VBR)	VBR / AVBR	AVBR (V1.40)	VBR / AVBR	AVBR (V1.40)	AVBR (V1.40)
	Smart coding	Yes	—	Yes	—	—
Max. Resolution	16 : 9	2560 x 1440	1920 x 1080	2560 x 1440	1920 x 1080	1920 x 1080
	4 : 3	2560 x 1920 2992 x 2992 (1 : 1)	H.264: 1280 x 960 JPEG : 2048 x 1536	2560 x 1920 2992 x 2992 (1 : 1)	H.264: 1280 x 960 JPEG : 2048 x 1536	H.264: 1280 x 960 JPEG : 2048 x 1536
Max. FPS @Max. Resolution	H.264	30fps (4 M)	30fps (1080p)	30fps (4 M)	30fps (1080p)	30fps (1080p)
	JPEG	30fps (4 M)	15fps (3 MP) / 30fps (1080p)	30fps (4 M)	15fps (3 MP) / 30fps (1080p)	15fps (3 MP) / 30fps (1080p)
Super Dynamic / WDR / BLC		WDR	Super-D	WDR	Super-D	Super-D
Day/Night		Yes (ICR)	Yes (Electrical)	Yes (Electrical)	Yes (Electrical)	Yes (Electrical)
ABF (Auto Back Focus) / Focus Assist		ABF	—	ABF	—	—
Min. Illumination	Color	0.3 lx @F1.9	1.5 lx @F2.4	0.3 lx @F1.9	1.5 lx @F2.4	1.5 lx @F2.4
	Color (Sens up)	0.02 lx (16x)	0.1 lx (16x)	0.02 lx (16x)	0.1 lx (16x)	0.1 lx (16x)
	B/W	0.04 lx @F1.9	1.2 lx @F2.4	0.2 lx @F1.9	1.2 lx @F2.4	1.2 lx @F2.4
	B/W (Sens up)	0.003 lx (16x)	0.08 lx (16x)	0.01 lx (16x)	0.08 lx (16x)	0.08 lx (16x)
Lens		f= 1.38 mm, F1.9	f= 0.837 mm, F2.4	f= 1.38 mm, F1.9	f= 0.837 mm, F2.4	f= 0.837 mm, F2.4
Angular field of view	1 : 1	H: 180 deg. V: 180 deg.	H: 182 deg. V: 176 deg.	H: 180 deg. V: 180 deg.	H: 182 deg. V: 176 deg.	H: 188 deg. V: 181 deg.
Adjusting Angle	Pan	±45 deg.	—	±45 deg.	—	—
	Tilt	±45 deg.	—	±45 deg.	—	—
Optical Zoom		—	—	—	—	—
Digital Zoom		4x	4x	4x	4x	4x
VMD (Video Motion Detection)		Yes (4-areas)	Yes (4-areas)	Yes (4-areas)	Yes (4-areas)	Yes (4-areas)
i-VMD (Intelligent VMD) (w/optional extension software)		Yes (Type3)	—	Yes (Type3)	—	—
VIQS		Yes (8-areas)	Yes (2-areas)	Yes (8-areas)	Yes (2-areas)	Yes (2-areas)
Max. Connection		14	14	14	14	14
Audio	In (Line)	Yes	Yes	Yes	Yes	Yes
	In (Built-in MIC)	—	—	Yes	Yes	Yes
	Out	Yes	Yes	Yes	Yes	Yes
	Codec	G.711 / G.726 / AAC	G.711 / G.726	G.711 / G.726 / AAC	G.711 / G.726	G.711 / G.726
	Audio Detection Alarm	—	—	—	—	—
SD memory Card	Slot	Yes (SDXC)	Yes (SDXC)	Yes (SDXC)	Yes (SDXC)	Yes (SDXC)
	Password & Alter Detection	—	—	—	—	—
	Audio REC	Yes	—	Yes	—	—
External I/O		Yes (3) (*2)	Yes (3) (*3)	Yes (3) (*3)	Yes (3) (*4)	Yes (3) (*3)
Monitor Out		Yes (RCA)	—	Yes (RCA)	—	—
Vandal Resistant		50J, IK10	50J, IK10	—	20J, IK10	—
Water and Dust Resistance		IP66 / NEMA 4X	IP66 / NEMA 4X	—	—	—
Temperature		-40 to +50 deg.	-40 to +50 deg.	Ceiling / Wall / Mount bracket: -10 to +50 deg. Desktop / Tripod: -10 to +40 deg.	-10 to +50 deg.	-10 to +50 deg.
Power Source		12 V DC / PoE	12 V DC / PoE	12 V DC / PoE	12 V DC / PoE	12 V DC / PoE
Dehumidification device		Yes	Yes	—	—	—
Other Functions		360° monitoring, EN50155-T3, EN50121, DIN5510	360° monitoring, EN50155-T3, EN50121, DIN5510, ECE-R10(WV-SW458MA)	360° monitoring	360° monitoring, Mechanical shutter	360° monitoring





(\*1): SW458: 10BASE-T/100BASE-TX, RJ45 connector, SW458MA: 10BASE-T/100BASE-TX, M12 connector (\*2): Alarm In1(Day/Night In), Alarm In2(Alarm Out), Alarm In3(AUX Out) (x1 for each) (\*3): Alarm In1, Alarm In2(Alarm Out), Alarm In3(AUX Out) (x1 for each) (\*4): Alarm In1(Privacy action in), Alarm In2(Alarm Out), Alarm In3(AUX Out) (x1 for each)

**Network Camera Comparison chart** **Box**

Indoor / Outdoor		Outdoor				
Model Name		WV-SPV781L	WV-SPW631LT	WV-SPW631L	WV-SPW611L	WV-SPW611
Appearance						
Sensor		1/1.7 MOS	1/3 MOS	1/3 MOS	1/3 MOS	1/3 MOS
Codec and Transmission	Video Codec	H.264 / JPEG	H.264 / JPEG	H.264 / JPEG	H.264 / JPEG	H.264 / JPEG
	H.264 multi stream	4	4	4	4	4
	JPEG multi stream	2	6 (Variable)	6 (Variable)	6 (Variable)	6 (Variable)
	H.264 VBR / AVBR (Advanced VBR)	VBR / AVBR	VBR / AVBR	VBR / AVBR	VBR / AVBR	VBR / AVBR
	Smart coding	Yes	Yes	Yes	Yes	Yes
Max. Resolution	16 : 9	3840 x 2160	1920 x 1080	1920 x 1080	1280 x 720	1280 x 720
	4 : 3	4000 x 3000	2048 x 1536 (*1)	2048 x 1536 (*1)	1280 x 960	1280 x 960
Max. FPS @Max. Resolution	H.264	30fps (4K)	60fps (1080p)	60fps (1080p)	60fps (720p)	60fps (720p)
	JPEG	15fps (12 MP)	30fps (3 MP)	30fps (3 MP)	30fps (1.3 MP)	30fps (1.3 MP)
Super Dynamic / WDR / BLC		WDR	Enhanced SD	Enhanced SD	Enhanced SD	Enhanced SD
Day/Night		Yes (ICR)	Yes (ICR)	Yes (ICR)	Yes (ICR)	Yes (ICR)
ABF (Auto Back Focus) / Focus Assist		ABF	ABF	ABF	ABF	ABF
Min. Illumination	Color	0.3 lx @F1.6	0.06 lx @F1.6	0.04 lx @F1.3	0.01 lx @F1.3	0.01 lx @F1.3
	Color (Sens up)	0.02 lx (16x)	0.004 lx (16x)	0.003 lx (16x)	0.0007 lx (16x)	0.0007 lx (16x)
	B/W	0.0 lx @F1.6 (w/IR)	0.0 lx @F1.6(w/IR)	0.0 lx @F1.3(w/IR)	0.0 lx @F1.3(w/IR)	0.003 lx @F1.3
	B/W (Sens up)	—	—	—	—	0.0002 lx (16x)
Lens		f=4.2 to 25.2 mm, F1.6 Motorized	f= 9 to 22 mm, F1.6 Motorized	f= 2.8 to 10 mm, F1.3 Motorized	f= 2.8 to 10 mm, F1.3 Motorized	f= 2.8 to 10 mm, F1.3 Motorized
Angular field of view	16 : 9	H: 17 to 97 deg. V: 9.4 to 55 deg.	H: 13.8 to 33.5 deg. V: 7.7 to 18.1 deg.	H: 30.9 to 105.4 deg. V: 17.4 to 57.3 deg.	H: 28.4 to 96.2 deg. V: 16.1 to 52.8 deg.	H: 28.4 to 96.2 deg. V: 16.1 to 52.8 deg.
	4 : 3	H: 18 to 101 deg. V: 13 to 76 deg.	H: 11.5 to 27.4 deg. V: 8.6 to 20.1 deg.	H: 25.8 to 86.4 deg. V: 19.3 to 63.9 deg.	H: 28.4 to 96.2 deg. V: 21.4 to 71.0 deg.	H: 28.4 to 96.2 deg. V: 21.4 to 71.0 deg.
Adjusting Angle	Pan	—	—	—	—	—
	Tilt	—	—	—	—	—
Optical Zoom		6x	2.4x	3.6x	3.6x	3.6x
Digital Zoom		4x	4x	4x	4x	4x
VMD (Video Motion Detection)		Yes (4-areas)	Yes (4-areas)	Yes (4-areas)	Yes (4-areas)	Yes (4-areas)
i-VMD (Intelligent VMD) (w/optional extension software)		—	Yes (Type2)	Yes (Type2)	Yes (Type2)	Yes (Type2)
VIQS		Yes (8-areas)	Yes (8-areas)	Yes (8-areas)	Yes (8-areas)	Yes (8-areas)
Max. Connection		14	14	14	14	14
Audio	In (Line)	Yes	Yes	Yes	Yes	Yes
	In (Built-in MIC)	—	—	—	—	—
	Out	Yes	Yes	Yes	Yes	Yes
	Codec	G.711 / G.726 / AAC (*2)	G.711 / G.726 / AAC	G.711 / G.726 / AAC	G.711 / G.726 / AAC	G.711 / G.726 / AAC
	Audio Detection Alarm	—	Yes	Yes	Yes	Yes
SD memory Card	Slot	Yes (SDXC)	Yes (SDXC x 2)	Yes (SDXC x 2)	Yes (SDXC x 2)	Yes (SDXC x 2)
	Password & Alter Detection	—	Yes	Yes	Yes	Yes
	Audio REC	Yes	Yes	Yes	Yes	Yes
External I/O		Yes (3) (*3)	Yes (3) (*4)	Yes (3) (*4)	Yes (3) (*4)	Yes (3) (*4)
Monitor Out		Yes (RCA)	Yes (RCA)	Yes (RCA)	Yes (RCA)	Yes (RCA)
Vandal Resistant		20J, IK10	—	—	—	—
Water and Dust Resistance		IP66 / NEMA 4X	IP66 / NEMA 4X	IP66 / NEMA 4X	IP66 / NEMA 4X	IP66 / NEMA 4X
Temperature		-45 to +50 deg.	-40 to +50 deg.	-40 to +50 deg.	-40 to +50 deg.	-40 to +50 deg.
Power Source		12 V DC / PoE	12 V DC / PoE	12 V DC / PoE	12 V DC / PoE	12 V DC / PoE
Dehumidification device		Yes	Yes	Yes	Yes	Yes
Other Functions		Built-in heater, Rain wash coating, Built-in IR LED	Smart DoF, Built-in heater, Built-in IR LED	Smart DoF, Built-in heater, Built-in IR LED	Smart DoF, Built-in heater, Built-in IR LED	Smart DoF, Built-in heater

(\*1): w/Super resolution (\*2): Only for SD REC (\*3): Alarm In1(Day/Night In), Alarm In2(Alarm Out), Alarm In3(AUX Out, Day/Night Out) (x1 for each) (\*4): Alarm In1(Day/Night In), Alarm In2(Alarm Out), Alarm In3(AUX Out) (x1 for each)

**Network Camera Comparison chart** **Box**

Indoor / Outdoor		Outdoor			
Model Name		WV-SPW531AL	WV-SPW532L	WV-SPW311AL	WV-SPW312L
Appearance					
Sensor		1/3 MOS	1/3 MOS	1/3 MOS	1/3 MOS
Codec and Transmission	Video Codec	H.264 / JPEG	H.264 / JPEG	H.264 / JPEG	H.264 / JPEG
	H.264 multi stream	4	4	4	4
	JPEG multi stream	6 (Variable)	6 (Variable)	6 (Variable)	6 (Variable)
	H.264 VBR / AVBR (Advanced VBR)	VBR / AVBR	VBR / AVBR	VBR / AVBR	VBR / AVBR
	Smart coding	Yes	Yes	Yes	Yes
Max. Resolution	16 : 9	1920 x 1080	1920 x 1080	1920 x 1080 (*1) / 1280 x 720	1280 x 720
	4 : 3	2048 x 1536	2048 x 1536	1920 x 1080 (*1)	1920 x 1080 (*1)
Max. FPS @Max. Resolution	H.264	60fps (1080p)	30fps (1080p)	60fps (720p)	30fps (720p)
	JPEG	30fps (3 MP)	30fps (3 MP)	30fps (1.3 MP)	30fps (1.3 MP)
Super Dynamic / WDR / BLC		Enhanced SD	WDR	Enhanced SD	WDR
Day/Night		Yes (ICR)	Yes (ICR)	Yes (ICR)	Yes (ICR)
ABF (Auto Back Focus) / Focus Assist		ABF	ABF	ABF	ABF
Min. Illumination	Color	0.07 lx @F1.6	0.07 lx @F1.6	0.02 lx @F1.6	0.02 lx @F1.6
	Color (Sens up)	0.005 lx (16x)	0.005 lx (16x)	0.0013 lx (16x)	0.0013 lx (16x)
	B/W	0.0 lx @F1.6(w/IR)	0.0 lx @F1.6(w/IR)	0.0 lx @F1.6(w/IR)	0.0 lx @F1.6(w/IR)
	B/W (Sens up)	—	—	—	—
Lens		f= 2.8 to 10 mm, F1.6	f= 2.8 to 10 mm, F1.6	f= 2.8 to 10 mm, F1.6	f= 2.8 to 10 mm, F1.6
Angular field of view	16 : 9	H: 31 to 112 deg. V: 17 to 60 deg.	H: 31 to 112 deg. V: 17 to 60 deg.	H: 28 to 102 deg. V: 16 to 55 deg.	H: 28 to 102 deg. V: 16 to 55 deg.
	4 : 3	H: 26 to 91 deg. V: 19 to 67 deg.	H: 26 to 91 deg. V: 19 to 67 deg.	H: 28 to 102 deg. V: 21 to 74 deg.	H: 28 to 102 deg. V: 21 to 74 deg.
Adjusting Angle	Pan	-180 to +180 deg.	-180 to +180 deg.	-180 to +180 deg.	-180 to +180 deg.
	Tilt	0 to +90 deg.	0 to +90 deg.	0 to +90 deg.	0 to +90 deg.
Optical Zoom		3.6x	3.6x	3.6x	3.6x
Digital Zoom		4x	4x	4x	4x
VMD (Video Motion Detection)		Yes (4-areas)	Yes (4-areas)	Yes (4-areas)	Yes (4-areas)
i-VMD (Intelligent VMD) (w/optional extension software)		Yes (Type2)	Yes (Type2)	Yes (Type2)	Yes (Type2)
VIQS		Yes (8-areas)	Yes (8-areas)	Yes (8-areas)	Yes (8-areas)
Max. Connection		14	14	14	14
Audio	In (Line)	Yes	—	Yes	—
	In (Built-in MIC)	—	—	—	—
	Out	Yes	—	Yes	—
	Codec	G.711 / G.726 / AAC	—	G.711 / G.726 / AAC	—
	Audio Detection Alarm	Yes	—	Yes	—
SD memory Card	Slot	Yes (SDXC)	Yes (SDXC)	Yes (SDXC)	Yes (SDXC)
	Password & Alter Detection	Yes	Yes	Yes	Yes
	Audio REC	Yes (AAC)	—	Yes (AAC)	—
External I/O		Yes (3) (*2)	—	Yes (3) (*2)	—
Monitor Out		Yes (RCA)	Yes (RCA)	Yes (RCA)	Yes (RCA)
Vandal Resistant		—	—	—	—
Water and Dust Resistance		IP66 / NEMA 4X	IP66 / NEMA 4X	IP66 / NEMA 4X	IP66 / NEMA 4X
Temperature		-40 to +50 deg.	-30 to +50 deg.	-40 to +50 deg.	-30 to +50 deg.
Power Source		12 V DC / PoE	PoE	12 V DC / PoE	PoE
Dehumidification device		Yes	—	Yes	—
Other Functions		Built-in heater, Built-in IR LED	Built-in heater, Built-in IR LED	Built-in heater, Built-in IR LED	Built-in heater, Built-in IR LED







(\*1): w/Super resolution (\*2): Alarm In1 (Day/Night In, Auto time adjustment), Alarm In 2 (Alarm Out), Alarm In 3 (AUX Out) (x1 for each)

New Products  
Function Introduction  
Network Camera Comparison Chart  
PTZ  
Fixed Dome  
360-degree Dome  
Box  
Pan/Tilt  
Network products  
Other

New Products  
Function Introduction  
Network Camera Comparison Chart  
PTZ  
Fixed Dome  
360-degree Dome  
Box  
Pan/Tilt  
Network products  
Other

Network Camera Comparison chart









Box

Indoor / Outdoor		Indoor		
Model Name		WV-SPN631	WV-SPN611	WV-SPN531A
Appearance		 Lens not included 	 Lens not included 	 Lens not included 
Sensor		1/3 MOS	1/3 MOS	1/3 MOS
Codec and Transmission		Video Codec	H.264 / JPEG	H.264 / JPEG
		H.264 multi stream	4	4
		JPEG multi stream	6 (Variable)	6 (Variable)
		H.264 VBR / AVBR (Advanced VBR)	VBR / AVBR	VBR / AVBR
		Smart coding	Yes	Yes
Max. Resolution		16 : 9	1920 x 1080	1920 x 1080
		4 : 3	2048 x 1536 (*1)	1280 x 960
Max. FPS @Max. Resolution		H.264	60fps (1080p)	60fps (720p)
		JPEG	30fps (3 MP) (*1)	30fps (1.3 MP)
Super Dynamic / WDR / BLC		Enhanced SD	Enhanced SD	Enhanced SD
Day/Night		Yes (ICR)	Yes (ICR)	Yes (ICR)
ABF (Auto Back Focus) / Focus Assist		ABF	ABF	ABF
Min. Illumination		Color	0.04 lx @F1.4	0.01 lx @F1.4
		Color (Sens up)	0.003 lx (16x)	0.0007 lx (16x)
		B/W	0.01 lx @F1.4	0.003 lx @F1.4
		B/W (Sens up)	0.0007 lx (16x)	0.0002 lx (16x)
Lens		CS Mount	CS Mount	CS Mount
Angular field of view		16 : 9	—	—
		4 : 3	—	—
Adjusting Angle		Pan	—	—
		Tilt	—	—
Optical Zoom		—	—	—
Digital Zoom		4x	4x	4x
VMD (Video Motion Detection)		Yes (4-areas)	Yes (4-areas)	Yes (4-areas)
i-VMD (Intelligent VMD) (w/optional extension software)		Yes (Type2)	Yes (Type2)	Yes (Type2)
VIQS		Yes (8-areas)	Yes (8-areas)	Yes (8-areas)
Max. Connection		14	14	14
Audio		In (Line)	Yes	Yes
		In (Built-in MIC)	—	—
		Out	Yes	Yes
		Codec	G.711 / G.726 / AAC	G.711 / G.726 / AAC
		Audio Detection Alarm	Yes	Yes
SD memory Card		Slot	Yes (SDXC x 2)	Yes (SDXC)
		Password & Alter Detection	Yes	Yes
		Audio REC	Yes	Yes
External I/O		Yes (3) (*2)	Yes (3) (*2)	Yes (3) (*3)
Monitor Out		Yes (RCA)	Yes (RCA)	Yes (RCA)
Vandal Resistant		—	—	—
Water and Dust Resistance		—	—	—
Temperature		-10 to +50 deg.	-10 to +50 deg.	-10 to +50 deg.
Power Source		12 V DC / PoE	12 V DC / PoE	12 V DC / PoE
Dehumidification device		—	—	—
Other Functions		Optional Extension Unit	Optional Extension Unit	—

(\*1): w/Super resolution (\*2): Alarm In1(Day/Night In), Alarm In2(Alarm Out), Alarm In3(AUX Out) (x1 for each) (\*3): Alarm In1 (Day/Night In, Auto time adjustment), Alarm In 2 (Alarm Out), Alarm In 3 (AUX Out) (x1 for each)

Network Camera Comparison chart



Box / Cylinder

Indoor / Outdoor		Indoor			
Model Name		WV-SPN311A	WV-SPN310A	WV-SP105	WV-SP102
Appearance		 Lens not included 	 Lens not included 	 	 
Sensor		1/3 MOS	1/3 MOS	1/3 MOS	1/5 MOS
Codec and Transmission		Video Codec	H.264 / JPEG	H.264 / JPEG	H.264 / JPEG
		H.264 multi stream	4	4	2
		JPEG multi stream	6 (Variable)	6 (Variable)	6
		H.264 VBR / AVBR (Advanced VBR)	VBR / AVBR	VBR / AVBR	AVBR (V1.80)
		Smart coding	Yes	Yes	—
Max. Resolution		16 : 9	1920 x 1080 (*1) / 1280 x 720	1920 x 1080 (*1) / 1280 x 720	1280 x 720
		4 : 3	1280 x 960	1280 x 960	1280 x 960
Max. FPS @Max. Resolution		H.264	60fps (720p)	60fps (720p)	30fps (1.3 MP)
		JPEG	30fps (1.3 MP)	30fps (1.3 MP)	30fps (1.3 MP)
Super Dynamic / WDR / BLC		Enhanced SD	Enhanced SD	BLC	BLC
Day/Night		Yes (ICR)	Yes (Electrical)	Yes (Electrical)	Yes (Electrical)
ABF (Auto Back Focus) / Focus Assist		ABF	Focus Assist	—	—
Min. Illumination		Color	0.01 lx @F1.4	0.01 lx @F1.4	0.8 lx @F2.2
		Color (Sens up)	0.0007 lx (16x)	0.0007 lx (16x)	0.05 lx (16x)
		B/W	0.003 lx @F1.4	0.008 lx @F1.4	0.4 lx @F2.2
		B/W (Sens up)	0.0002 lx (16x)	0.0005 lx (16x)	0.03 lx (16x)
Lens		CS Mount	CS Mount	f= 3.54 mm, F2.2	f= 2 mm, F2.0
Angular field of view		16 : 9	—	H: 70.3 deg. V: 42.6 deg.	H: 66.9 deg. V: 39.2 deg.
		4 : 3	—	H: 70.3 deg. V: 55.4 deg.	H: 66.9 deg. V: 52.3 deg.
Adjusting Angle		Pan	—	—	—
		Tilt	—	—	—
Optical Zoom		—	—	—	—
Digital Zoom		4x	4x	4x	4x
VMD (Video Motion Detection)		Yes (4-areas)	Yes (4-areas)	Yes (4-areas)	Yes (4-areas)
i-VMD (Intelligent VMD) (w/optional extension software)		Yes (Type2)	Yes (Type2)	—	—
VIQS		Yes (8-areas)	Yes (8-areas)	Yes (1-area)	Yes (1-area)
Max. Connection		14	14	14	14
Audio		In (Line)	Yes	—	—
		In (Built-in MIC)	—	Yes	—
		Out	Yes	—	—
		Codec	G.711 / G.726 / AAC	G.711 / G.726 / AAC	—
		Audio Detection Alarm	Yes	Yes	—
SD memory Card		Slot	Yes (SDXC)	Yes (SDXC)	—
		Password & Alter Detection	Yes	Yes	—
		Audio REC	Yes	Yes	—
External I/O		Yes (3) (*2)	Yes (3) (*3)	—	—
Monitor Out		Yes (RCA)	Yes (RCA)	—	—
Vandal Resistant		—	—	—	—
Water and Dust Resistance		—	—	—	—
Temperature		-10 to +50 deg.	-10 to +50 deg.	0 to +40 deg.	0 to +40 deg.
Power Source		12 V DC / PoE	12 V DC / PoE	12 V DC / PoE	12 V DC / PoE
Dehumidification device		—	—	—	—
Other Functions		—	—	—	—

(\*1): w/Super resolution (\*2): Alarm In1 (Day/Night In, Auto time adjustment), Alarm In 2 (Alarm Out), Alarm In 3 (AUX Out) (x1 for each) (\*3): Alarm In1 (Auto time adjustment), Alarm In 2 (Alarm Out), Alarm In 3 (AUX Out) (x1 for each)

Network Camera Comparison chart





Pan / Tilt

Indoor / Outdoor		Outdoor		
Model Name		WV-SW175	WV-SW174W	WV-SW172
Appearance		 ONVIF®   S	 ONVIF®   S	 ONVIF®   S
Sensor		1/4 MOS	1/4 MOS	1/4 MOS
Codec and Transmission	Video Codec	H.264 / JPEG	H.264 / JPEG	H.264 / JPEG
	H.264 multi stream	2	2	2
	JPEG multi stream	6	6	6
	H.264 VBR / AVBR (Advanced VBR)	AVBR (V1.80)	AVBR (V1.80)	AVBR (V1.80)
	Smart coding	—	—	—
Max. Resolution	16 : 9	1280 x 720	1280 x 720	640 x 360
	4 : 3	1280 x 960	1280 x 960	800 x 600
Max. FPS @Max. Resolution	H.264	30fps (1.3 MP)	30fps (1.3 MP)	30fps (SVGA)
	JPEG	30fps (1.3 MP)	30fps (1.3 MP)	30fps (SVGA)
Super Dynamic / WDR / BLC		WDR	WDR	WDR
Day/Night		Yes (Electrical)	Yes (Electrical)	Yes (Electrical)
ABF (Auto Back Focus) / Focus Assist		—	—	—
Min. Illumination	Color	0.6 lx @F2.2	0.6 lx @F2.2	0.6 lx @F2.2
	Color (Sens up)	0.038 lx (16x)	0.038 lx (16x)	0.038 lx (16x)
	B/W	0.5 lx @F2.2	0.5 lx @F2.2	0.5 lx @F2.2
	B/W (Sens up)	0.03 lx (16x)	0.03 lx (16x)	0.03 lx (16x)
Lens		f= 1.95 mm, F2.2	f= 1.95 mm, F2.2	f= 1.95 mm, F2.2
Angular field of view	16 : 9	H: 85 deg. V: 53 deg.	H: 85 deg. V: 53 deg.	H: 85 deg. V: 53 deg.
	4 : 3	H: 85 deg. V: 68 deg.	H: 85 deg. V: 68 deg.	H: 85 deg. V: 68 deg.
Pan	Range	-47.5 to +47.5 deg.	-47.5 to +47.5 deg.	-47.5 to +47.5 deg.
	Speed	80 deg/sec	80 deg/sec	80 deg/sec
Tilt	Range	-45 to +10 deg.	-45 to +10 deg.	-45 to +10 deg.
	Speed	80 deg/sec	80 deg/sec	80 deg/sec
360 Pan-Flip		—	—	—
Number of Preset Positions		64	64	64
Patrol		—	—	—
Auto Tracking		—	—	—
Optical Zoom		—	—	—
Digital Zoom		8x	8x	8x
VMD (Video Motion Detection)		Yes	Yes	Yes
i-VMD (Intelligent VMD) (w/optional extension software)		—	—	—
VIQS		—	—	—
Max. Connection		14	14	14
Audio	In (Line)	Yes	Yes	Yes
	In (Built-in MIC)	Yes	Yes	Yes
	Out	Yes	Yes	Yes
	Codec	G.711 / G.726	G.711 / G.726	G.711 / G.726
Audio Detection Alarm		—	—	—
SD memory Card	Slot	Yes (SDHC)	—	Yes (SDHC)
	Password & Alter Detection	—	—	—
	Audio REC	—	—	—
External I/O		Yes (3) (*1)	Yes (3) (*1)	Yes (3) (*1)
Monitor Out		Yes (mini jack)	Yes (mini jack)	Yes (mini jack)
Vandal Resistant		—	—	—
Water and Dust Resistance		IP55	IP55	IP55
Temperature		-20 to +50 deg.	-20 to +50 deg.	-20 to +50 deg.
Power Source		12 V DC / PoE	12 V DC	12 V DC / PoE
Dehumidification device		—	—	—
Other Functions		—	Wireless (11 n/b/g)	—

(\*1) : Alarm In1, Alarm In2(Alarm Out), Alarm In3(AUX Out) (x1 for each)

Network Camera Comparison chart

Pan / Tilt

Indoor / Outdoor		Indoor			
Model Name		WV-ST165	WV-ST162	BL-VT164W	BL-VT164
Appearance		 ONVIF®   S	 ONVIF®   S	 ONVIF®   S	 ONVIF®   S
Sensor		1/4 MOS	1/4 MOS	1/4 MOS	1/4 MOS
Codec and Transmission	Video Codec	H.264 / JPEG	H.264 / JPEG	H.264 / JPEG	H.264 / JPEG
	H.264 multi stream	2	2	2	2
	JPEG multi stream	6	6	6	6
	H.264 VBR / AVBR (Advanced VBR)	AVBR (V1.80)	AVBR (V1.80)	AVBR (V1.80)	AVBR (V1.80)
	Smart coding	—	—	—	—
Max. Resolution	16 : 9	1280 x 720	640 x 360	1280 x 720	1280 x 720
	4 : 3	1280 x 960	800 x 600	800 x 600	800 x 600
Max. FPS @Max. Resolution	H.264	30fps (1.3 MP)	30fps (SVGA)	30fps (1 MP)	30fps (1 MP)
	JPEG	30fps (1.3 MP)	30fps (SVGA)	30fps (1 MP)	30fps (1 MP)
Super Dynamic / WDR / BLC		WDR	WDR	BLC	BLC
Day/Night		Yes (Electrical)	Yes (Electrical)	Yes (Electrical)	Yes (Electrical)
ABF (Auto Back Focus) / Focus Assist		—	—	—	—
Min. Illumination	Color	0.6 lx @F2.2	0.6 lx @F2.2	0.9 lx @F2.8	0.9 lx @F2.8
	Color (Sens up)	0.038 lx (16x)	0.038 lx (16x)	0.06 lx (16x)	0.06 lx (16x)
	B/W	0.5 lx @F2.2	0.5 lx @F2.2	0.6 lx @F2.8	0.6 lx @F2.8
	B/W (Sens up)	0.03 lx (16x)	0.03 lx (16x)	0.04 lx (16x)	0.04 lx (16x)
Lens		f= 1.95 mm, F2.2	f= 1.95 mm, F2.2	f= 3.6 mm, F2.8	f= 3.6 mm, F2.8
Angular field of view	16 : 9	H: 85 deg. V: 53 deg.	H: 85 deg. V: 53 deg.	H: 57 deg. V: 34 deg.	H: 57 deg. V: 34 deg.
	4 : 3	H: 85 deg. V: 68 deg.	H: 85 deg. V: 68 deg.	H: 44 deg. V: 34 deg.	H: 44 deg. V: 34 deg.
Pan	Range	-47.5 to +47.5 deg.	-47.5 to +47.5 deg.	-41 to +41 deg.	-41 to +41 deg.
	Speed	80 deg/sec	80 deg/sec	50 deg/sec	0.5 to 50 deg/sec
Tilt	Range	-45 to +10 deg.	-45 to +10 deg.	-32 to +10 deg.	-32 to +10 deg.
	Speed	80 deg/sec	80 deg/sec	50 deg/sec	0.5 to 50 deg/sec
360 Pan-Flip		—	—	—	—
Number of Preset Positions		64	64	64	64
Patrol		—	—	—	—
Auto Tracking		—	—	—	—
Optical Zoom		—	—	—	—
Digital Zoom		8x	8x	8x	8x
VMD (Video Motion Detection)		Yes	Yes	Yes	Yes
i-VMD (Intelligent VMD) (w/optional extension software)		—	—	—	—
VIQS		—	—	—	—
Max. Connection		14	14	14	14
Audio	In (Line)	Yes	Yes	—	—
	In (Built-in MIC)	Yes	Yes	Yes	Yes
	Out	Yes	Yes	Yes (*1)	Yes (*1)
	Codec	G.711 / G.726	G.711 / G.726	G.711 / G.726	G.711 / G.726
Audio Detection Alarm		—	—	—	—
SD memory Card	Slot	Yes (SDHC)	Yes (SDHC)	—	—
	Password & Alter Detection	—	—	—	—
	Audio REC	—	—	—	—
External I/O		Yes (3) (*2)	Yes (3) (*2)	Yes (3) (*2)	Yes (3) (*2)
Monitor Out		Yes (mini jack)	Yes (mini jack)	—	—
Vandal Resistant		—	—	—	—
Water and Dust Resistance		—	—	—	—
Temperature		0 to +40 deg.	0 to +40 deg.	0 to +40 deg.	0 to +40 deg.
Power Source		12 V DC / PoE	12 V DC / PoE	9 V DC	9 V DC
Dehumidification device		—	—	—	—
Other Functions		—	—	Wireless (11 b/g) WPS, Body heat Sensor, AC Adapter	Body heat Sensor, AC Adapter

(\*1): Built-in speaker (\*2): Alarm In1, Alarm In2(Alarm Out), Alarm In3(AUX Out) (x1 for each)





Optional Accessories Compatibility with Network Cameras

	Bracket			Dome Cover		Other
	Wall Mount Bracket	Ceiling Mount Bracket		Smoke	Clear	
<b>WV-SUD638</b> (Natural Silver) <b>WV-SUD638-H</b> (Gray) <b>WV-SUD638-T</b> (Brown)						WV-SUD6FRL1 (Natural Silver) WV-SUD6FRL-H (Gray) WV-SUD6FRL-T (Brown) IR LED unit 
<b>WV-SW598A</b>	WV-Q122A 	WV-Q121B 				
<b>WV-SW397B</b>						
<b>WV-SW395(A)</b>						
<b>WV-SC588A</b>	WV-Q119 			WV-Q126A 	WV-CS5S 	WV-CS5C 
<b>WV-SC387A</b>		WV-Q105A 				
<b>WV-SC385</b>	WV-Q154S/WV-Q154C 			WV-Q155S/ WV-Q155C 	WV-Q156S/ WV-Q156C 	WV-Q157 Inner Dome Cover 
<b>WV-SC384</b>	 Smoke Type			 Smoke Type	 Smoke Type	
<b>WV-SFV631LT</b>						
<b>WV-SFV631L</b>						
<b>WV-SFV611L</b>	WV-Q122A (*1) 	WV-Q124 	WV-Q121B (*1) 	WV-Q105A(*2) 	WV-Q169A 	WV-CW7S 
<b>WV-SFV531</b>						WV-Q7118 Sun Shade 
<b>WV-SFV311A</b>						
<b>WV-SFV310A</b>						
<b>WV-SFV130(M)</b>						
<b>WV-SFV110(M)</b>						WV-CW6SA 
<b>WV-SW158</b>						
<b>WV-SW155(MA)</b>						
<b>WV-SFR631L</b>						
<b>WV-SFR611L</b>		WV-Q105A 		WV-Q174B 	WV-CR1S 	
<b>WV-SFR531</b>						

(\*1): Used in combination with WV-Q124. (\*2): For Indoor installation only

Optional Accessories Compatibility with Network Cameras

	Bracket			Dome Cover		Other
	Wall Mount Bracket	Ceiling Mount Bracket		Smoke	Clear	
<b>WV-SFR311A</b>				WV-CR1S 		
<b>WV-SFR310A</b>						
<b>WV-SFN631L</b>						
<b>WV-SFN611L</b>		WV-Q105A 	WV-Q174B 	WV-CF5SA 		
<b>WV-SFN531</b>						
<b>WV-SFN311L</b>						
<b>WV-SFN311A</b>						
<b>WV-SFN310A</b>						
<b>WV-SFN130</b>						
<b>WV-SFN110</b>						
<b>WV-SF138</b>				WV-CW6SA 		
<b>WV-SF135</b>						
<b>WV-SF132</b>						
<b>WV-SPW531AL</b>						WV-Q120A Adapter Box 
<b>WV-SPW311AL</b>						
<b>WV-SPN631</b>						WV-SPN6FRL1 IR LED unit 
<b>WV-SPN611</b>						WV-SPN6R481 RS485 Output unit 
<b>WV-SFV481</b>	WV-Q122A (*1) 	WV-Q124 	WV-Q121B (*1) 			
<b>WV-SW458(MA)</b>						
<b>WV-SFN480</b>						
<b>WV-SF448</b>		WV-Q105A 				
<b>WV-SF438</b>						

(\*1): Used in combination with WV-Q124.



# Panasonic Security Viewer Ver.2.2

## Introduction of the application

**Panasonic Security Viewer Ver.2.2** is an application that can view the images from i-PRO SmartHD Series Network Cameras, Network Disk Recorder (WJ-NV200 / WJ-NV300 / WJ-ND400 / WJ-HD616 / WJ-HD716). By connecting a terminal to a 3G/4G or wireless LAN (Wi-Fi), it is possible to view live images from cameras registered on the recorder and recorded images stored on recorders.

### Preface

To use the **Panasonic Security Viewer** via the Internet, it is recommended to register in the Dynamic DNS (DDNS) service.

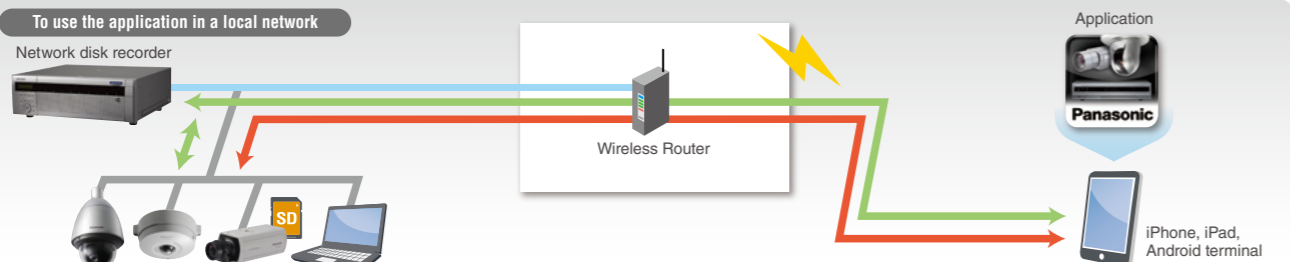
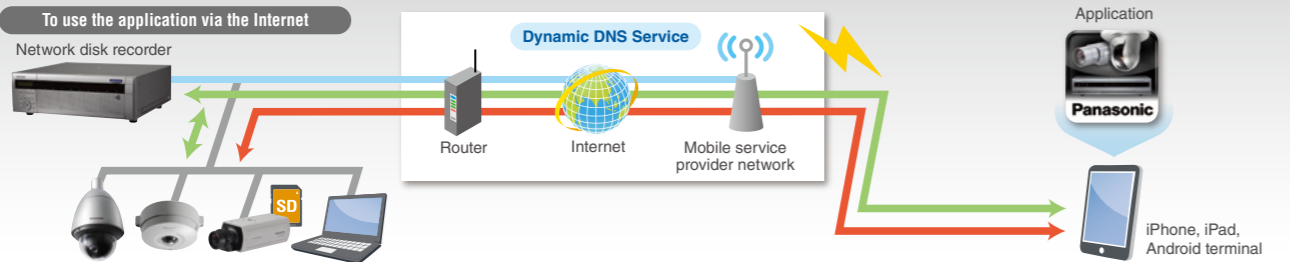

A PC is required to register a Dynamic DNS Service and configure the settings of the router.

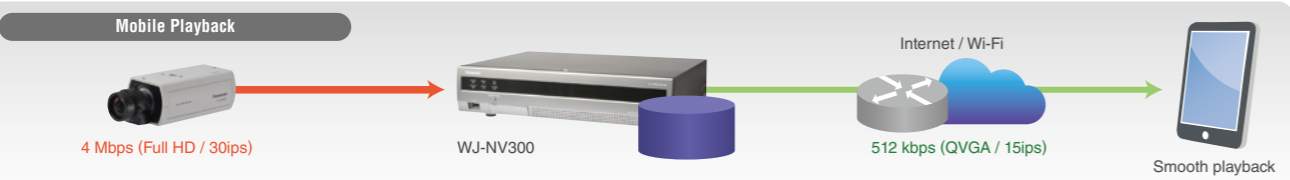

WJ-NV300 can transcode image size/bit rate to fit the customers environment, and stream it. This mode can be used by WJ-NV300 only.(Ver.1.03 or later)

- Download the Panasonic Security Viewer application on the Google play™ store, Apple App Store.

### Features of the application

#### Network disk recorder

- Live image: Live images from the network cameras connected to the recorder
- Playing back recorded images: To play back the images stored on the recorder
- New Feature : Mobile Playback feature (WJ-NV300 Only)
- Time & date search: To search the images to play back based on the time & date

#### Network camera

- Network camera control\* (Resolution switchover, focus, panning / tilting, zoom, preset position switchover)
- Playing back recorded image in the SD memory card\*
- \* Depends on the network camera functions.

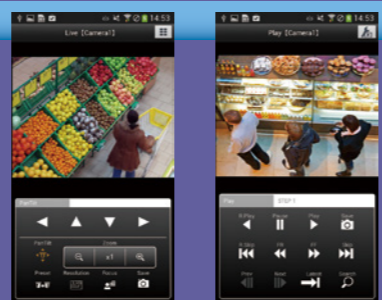

### Android™

#### Outline of the application

Application name	<b>Panasonic Security Viewer version 2.2</b>
OS	Android™ OS 4.0.3 / 4.0.4 / 4.2.2 / 4.3 / 4.4 / 5.1 is recommended.
How to get the application	Download from the Google play™ store.
Date to start the service	March-2016
Operation check terminals	Panasonic TOUGHPAD FZ-A1, JT-B1, Galaxy S2, Galaxy S3, Galaxy S4, Nexsu 7, Nexus 5

- Download the application from here.

<http://security.panasonic.com/pss/security/psv/android/index.html>

### iPhone / iPad

#### Outline of the application

Application name	<b>Panasonic Security Viewer version 2.2</b>
OS	iOS 7.1.2 or later
How to get the application	Download from the App Store.
Date to start the service	March-2016
Operation check terminals	iPhone5, iPhone5s, iPhone6, iPhone6 Plus, iPad2, iPad Retina, iPad Air

- Download the application from here.

<http://security.panasonic.com/pss/security/psv/ios/index.html>

## Easily migrate to an advanced IP system while still using the existing assets of your analog system

### Effective utilization of analog cameras

#### Encoder

- Analog cameras can be connected to the IP network simply by connecting them to the encoder.
- A maximum of four analog cameras can be connected to the WJ-GXE500, and one analog camera can be connected to the WJ-GXE100.
- Video captured by analog cameras can be saved to a recorder installed on the IP network in the same way as network cameras.

#### Basic System Connection Example

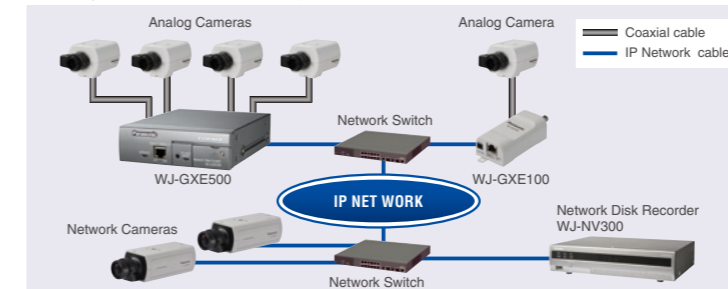

4 CH H.264 Video Encoder

### WJ-GXE500

(12 V DC or PoE)



#### Optional Accessory

EIA 48.26 cm (19 inch) Rack Mount Bracket **WV-Q204/2S** (for mounting three WJ-GXE500)

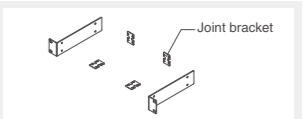

1 CH H.264 Video Encoder

### WJ-GXE100

(12 V DC or PoE)



### Effective utilization of cabling

#### Coaxial-LAN Converter

- The coaxial cables of existing analog cameras can be used for expanding the reach of the IP network.

#### Basic System Connection Example

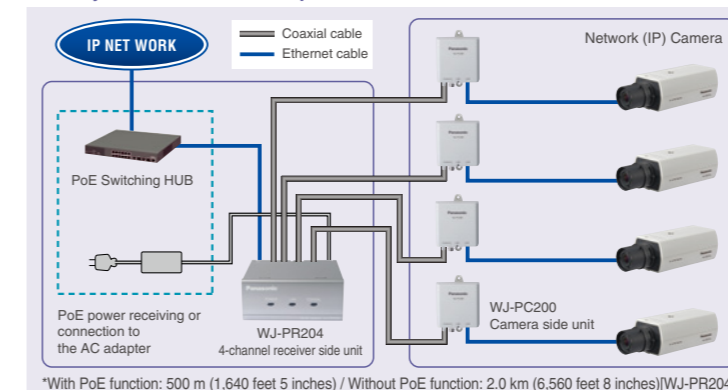

\*With PoE function: 500 m (1,640 feet 5 inches) / Without PoE function: 2.0 km (6,560 feet 8 inches)[WJ-PR204]

Coaxial LAN cables can be used up to distances of 2.0 km.[WJ-PR204] Power can also be supplied to PoE cameras for distances of up to 500 m, PoE+ cameras for distances of up to 300 m.

\*Distance will vary depending on the power supply environment. Please refer to the spec sheet for details.

Coaxial-LAN Converter with PoE function

4-channel receiver side unit

### WJ-PR204

1-channel receiver side unit

### WJ-PR201

(Indoor use only)

Camera side unit

### WJ-PC200

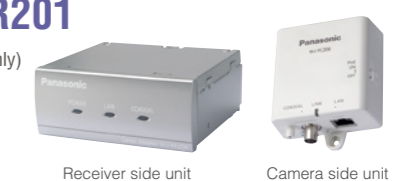

#### Optional Accessory

Rack Mount Connecting Fitting **BY-HCA10A** (for mounting three or four Receiver side unit)

- For U.S. and Canada : BY-HCA10A
- For Europe and other countries : BY-HCA10CE



### IP and analog integrated hybrid system

- The WV-ASC970/WV-ASM970 can be used to integrate management and operation of centralized systems that use both analog and IP system components.

#### Basic System Connection Example

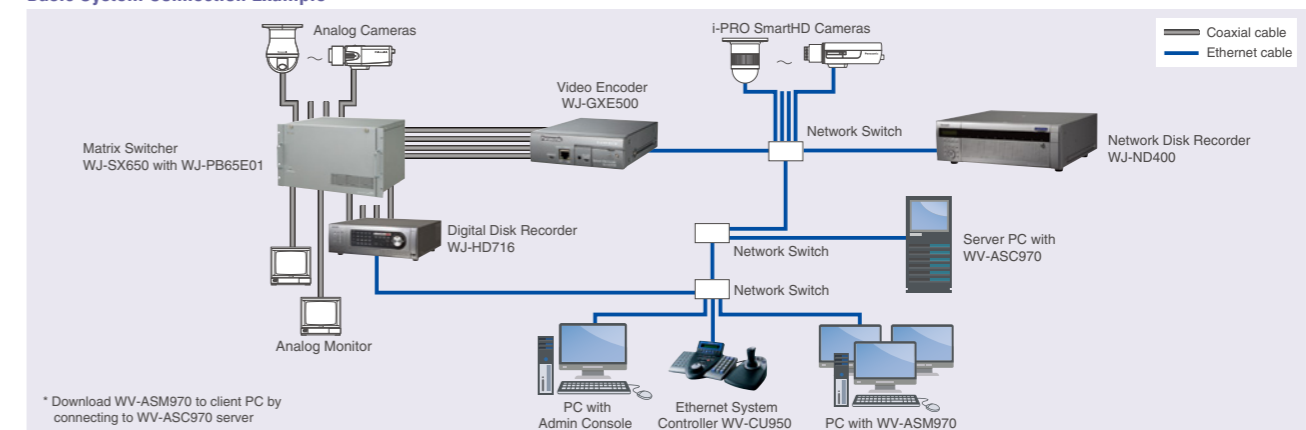

\* Download WV-ASM970 to client PC by connecting to WV-ASC970 server



With our proven track record of success in both analog and IP cameras, Panasonic can provide a one-stop equipment and system solution for successful migration from analog to IP.

Server based recording and video management platform

### WV-ASR500 Series



- Open platform, Panasonic's and over 70 other vendors network cameras support.
- Up to 128 network cameras can be connected and recorded.
- Up to 16 clients can monitor image and control WV-ASR500 simultaneously. (Depends on system structure, environment.)
- Various Recording Modes: Schedule, Event (Pre/Post)
- Graphical Timeline Search function (with WV-ASC970 System)
- Mobile monitoring applications for smart phone (iOS, Android)
- Cooperative with the Face Matching System (with WV-ASC970 System or WV-ASM200)
- Supports archiving function to realize long-term recording

**Advanced configuration**

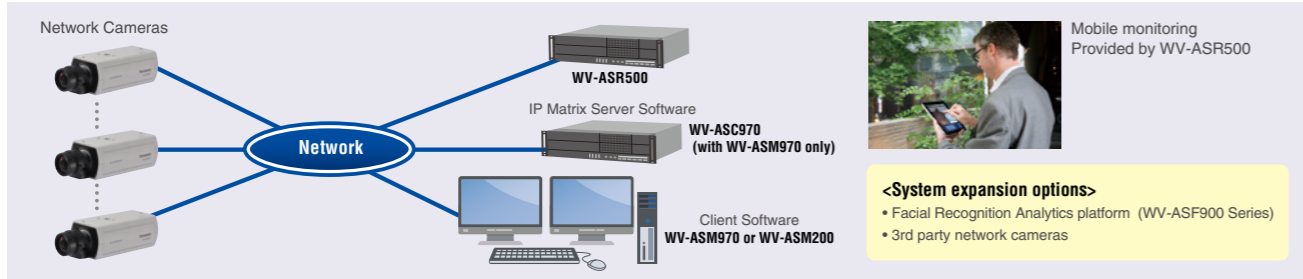

Recording Software (Channel License) per server: WV-ASRE501(1ch), WV-ASRE516(16ch), WV-ASRE532(32ch), WV-ASRE564(64ch)

### Network Disk Recorder WJ-ND400

(120 V AC: NTSC, 220-240 V AC: PAL)



**Optional Accessory**

Hard Disk Extension Unit WJ-HDE400



- Up to 64 network cameras can be connected and recorded (Video and Audio)
- Various Recording Mode: Manual, Schedule including Event (Pre/Post), Emergency
- VMD search (works with i-PRO cameras)
- Up to 54 HDD slots with 9 HDD slots in the main unit and five WJ-HDE400 optional Extension Units each with 9 HDD slots
- RAID5/6, Embedded OS, Data encryption for reliability

Network Camera Recorder with Viewer Software

### BB-HNP17



- Supports the recording and playback of H.264 cameras
- Supports resolutions of 2,048 x 1,536
- Remote Access Function
- Up to 64 cameras Register
- Event Detection Recording
- Flexible Layout
- Preset Sequence
- Timer recording with preset designation
- Pop-up display
- Time specified color night view



Multi Channel High Definition Video Decoder

### WJ-GXD400

(12 V DC, 100 V -240 V AC adapter attached)



- Up to 256 cameras, including cameras connected to the i-Pro Network Video Encoder (WJ-GXE500), can be registered
- HDMI interface supporting 1,920 x 1,080 display size
- 1x 4VGA image with 2x VGA images or 6x VGA images can be displayed in multiscreen mode
- Each of VGA images can be displayed at 25 frames/s.
- Up to 64 camera groups can be registered and called up in response to power on, group sequence and schedule program.

**Optional Accessories**

EIA 48.26 cm (19 inch) Rack Mount Bracket WJ-Q204/1S (for mounting one WJ-GXD400)

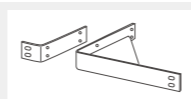

EIA 48.26 cm (19 inch) Rack Mount Bracket WJ-Q204/2S (for mounting two WJ-GXD400)

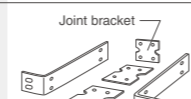

\*Only 3 pieces of joint brackets are necessary. One piece of joint bracket will be unnecessary.

### Network Disk Recorder WJ-NV300

(120 V AC: NTSC, 220 V -240 V AC: PAL)



- 16(NTSC) / 9(PAL) network cameras can be connected and recorded as default. Up to 32 network cameras can be connected and recorded.
- Quick setup by automatic camera detection and simple setup wizard without the use of PC
- Simple mouse operation by new GUI without the use of PC
- HDD capacity is expandable up to 20 HDD slots (2 HDD slots in the main unit and 2 optional WJ-HDE400 Hard Disk Extension Units each with 9 HDD slots).

\*1 Two Additional Camera Kits WJ-NVE30 are necessary.(NTSC) Three Additional Camera Kits WJ-NVE30 are necessary.(PAL)

**Additional Camera kit : WJ-NVE30**

**Optional Accessory**

Hard Disk Extension Unit WJ-HDE400



**Power Source**  
120 V AC, 60 Hz (NTSC)  
220 - 240 V AC, 50 Hz (PAL)

**Power Consumption** approx. 130 W

**Dimensions**  
430 mm (W) x 132 mm (H) x 400 mm (D)  
(16-15/16" (W) x 5-3/16" (H) x 15-12/16" (D))  
(excluding rubber feet and projections)

**Weight**  
13.5 kg (29.8 lbs.) (When no HDD exist)  
20 kg (44.15 lbs.) (When 9 HDDs are installed)

**Easy Operation and Setup without PC**

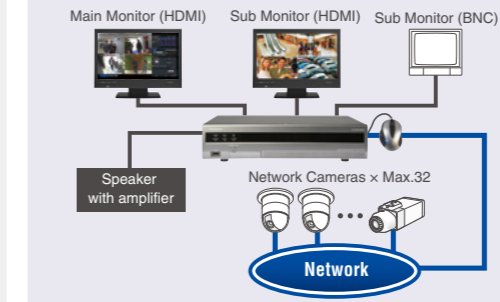

### Network Disk Recorder WJ-NV200

(120 V AC: NTSC, 220 V -240 V AC: PAL)



- Up to 16 network cameras can be connected and recorded.
- Quick setup by automatic camera detection and simple setup wizard without the use of PC
- Simple mouse operation by new GUI without the use of PC

**Easy Operation and Setup without PC**

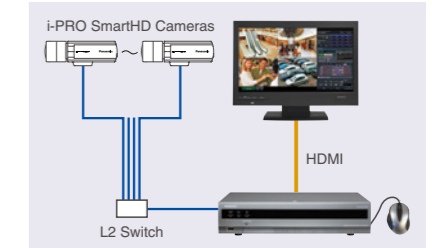

**Additional Business Intelligence Kit WJ-NVF30 WJ-NVF20**

Additional Business Intelligence Kit NVF20 is a license kit intended to improve the usefulness of Network Disk Recorder WJ-NV300 / WJ-NV200.



- New statistical processing functions such as "People counting" and "Face matching / Age & Gender judgment"
- The number of detected human faces can be displayed on a statistical chart separated by age & gender for a single day or a specified time period.
- Age distribution groups are displayed by separate colors.
- The statistical data can be saved as a CSV file on a SDHC/SD memory card or on a PC connected over a network.

\* To use this product, it is necessary to register the license (Registration Key) for Additional Business Intelligence Kit into the WJ-NV300/WJ-NV200 in use.

\* CSV file: A file that can be edited using a spreadsheet software such as Microsoft® Office Excel®

### WV-SMR10

(12V DC or PoE)



360-degree Network Microphone WV-SMR10 with 360-degree Network Camera WV-SF438

### WV-SMR10N3

\* WV-SMR10N3 is only sold in certain areas. Please contact the sales company for details.



**Optional Accessories**

Ceiling mount bracket WJ-Q105A



Ceiling pendant type mount bracket WJ-Q117A

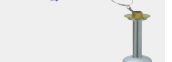

- **360-degree audio monitoring**  
With microphone arrays, 360-degree audio monitoring from a specified direction is possible.
- **Specifying a desired direction on a camera image**  
While watching the 360-degree Network Camera image, audio from the desired location can be freely specified by clicking on that location.
- **Synchronizing with the Network Disk Recorder**  
After recording audio to a Network Disk Recorder\*, the sound collecting direction can be specified while playing back the recorded image of the 360-degree Network Camera.  
\*Models WJ-NV300 and WJ-ND400 are supported
- **Can be installed with a 360-degree Network Camera as one unit**  
The microphone can be neatly installed in one place by integrating it with a Panasonic 360-degree Network Camera.

**System Example**

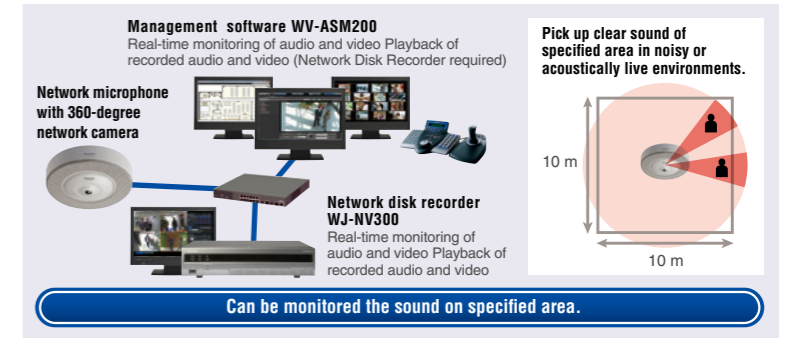

New Products, Function Introduction, Network Camera Comparison Chart, PTZ, Fixed Dome, 360-degree Dome, Box, Pan/Tilt, Network products, Other

New Products, Function Introduction, Network Camera Comparison Chart, PTZ, Fixed Dome, 360-degree Dome, Box, Pan/Tilt, Network products, Other

IP Matrix Server Software **WV-ASC970** IP Matrix Client Software **WV-ASM970** Extension Software **WV-ASE901\*** (Monitor the status of Fire Alarm System) / **WV-ASE902** / **WV-ASE903**



**Easy and smooth integration from analog to IP system**

- WV-ASC970**
- Flexible system design: Analog, IP, and Hybrid analog/IP
- Up to 64 recorders, 1,024 monitors, and 2,048 cameras (in case with encoder) can be registered
- Camera/Sequence/Monitor selection, Camera control and Recorder control can be made with the optional system controller WV-CU950
- Supported Recorders: WV-ASR500 Series, WJ-ND400 series, WJ-NV200 series, WJ-NV300 series, WJ-HD616/716 series
- Redundant function supported (Redundant function can consist of 2 WV-ASC970 servers as Main server and Standby server)
- Up to 64 ND400 recorders can be registered as Standby recorder for backup purpose of serious problems on main recorders

- Extension Software WV-ASE901\***
- Monitor the status of Fire Alarm System.
- Manually reset or acknowledge fire alarms and faults of Fire Alarm System.
- Search history of fire alarm, faults and interlocking of Fire Alarm System.
- \* WV-ASE901 is only sold in certain areas. Please contact the sales company for details.

- WV-ASM970**
- Multi-Monitor option enables simultaneous use of Operation screen and Monitor screen (1 / 4 / 7 / 9 / 10 / 13 / 16 split) on a dedicated monitor. Two monitor operation is also available.
- Up to 30 ips/camera can be displayed in 16 split-screen in MPEG-4 2 Mbps mode (depending on the camera, camera setup and PC performance).
- Up to 30 ips/camera can be displayed in 16 split-screen in H.264 1.5 Mbps mode with VGA (depending on the camera, camera setup and PC performance).
- Image resolution dynamically changes depending on the screen mode:VGA for Quad screen, QVGA for 16 split-screen, enabling optimum network usage (depending on the camera mode).

- Extension Software WV-ASE902**
- Up to 4 live monitor
- Multi monitor function up to 5 PC monitors
- To display the operation window and 4 live windows simultaneously

- Extension Software WV-ASE903**
- Visibility Enhancement Function
- \* Same as WV-ASE205 below.

i-PRO Management Software **WV-ASM200** Extension Software **WV-ASE201 / ASE202 / ASE203 / ASE204 / ASE205**



- Supports 16:9 video stream and 16:9 HD monitor. Displays 16:9 and 4:3 videos from IP cameras on the same screen.
- H.264 recording data in the SD / SDHC / SDXC memory card can be downloaded.
- Convert file format from n3r (proprietary format) to MP4.
- Up to 100 recorders, 64 encoders and 256 directly connected cameras can be registered. Up to 6,400 cameras registered in the recorders and 256 cameras registered in the encoders are automatically registered in the WV-ASM200 (the number of the cameras depends on the recorder and encoder).

- WV-ASE201**
- Add Live window, Map window in addition to the Operation window (3 monitors)
- Control using the Ethernet System Controller WV-CU950
- Expand the maximum numbers of screens to 20.
- \* To use the multi-monitor function, it is necessary to install an additional video card on the PC in use.

- WV-ASE202**
- Expand the maximum numbers of screens to 64.
- Up to 4 live windows.
- Multi-monitor function using up to 6 PC monitors.
- To display the operation window, the map window and the 4 map windows simultaneously.

- WV-ASE203**
- Expand the maximum numbers of registered recorders, encoders and cameras to 100, 64 and 256 respectively.
- Up to 4 licenses for the WV-ASE203 can be added.

- Optional Accessory**
- Ethernet System Controller with 3D-Joystick & Jog/Shuttle **WV-CU950** (WV-ASE201 is necessary.)

- WV-ASE204**
- Decoder registration: Up to 10 decoders

- WV-ASE205**
- Visibility Enhancement Function

- Spatial Tonal Correction**
- Snowfall and Rainfall Noise Reduction**
- Multi-frame Synthesis Noise Reduction**



Spatial Tonal Correction, Snowfall and Rainfall Noise Reduction

Face Recognition System **WV-ASF900 Series** Additional Camera Kit **1ch : WV-ASFE901 / 4ch : WV-ASFE904**



**Face Recognition System running in the video surveillance system**

- Add-on face matching function: Add the face matching function by simply adding the necessary devices and the software
- Can be connected up to 20 cameras on a server.

- Face search**
- Face images that camera detected are stored, and it can be searched later.
- By searching the face DB, you can display the result of each cameras in chronological order and find movement locus of persons.
- Specify camera or date in detected face images and display the result in the list in similarity order.

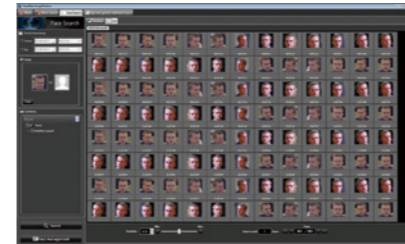

- Face Matching**
- When it is matched with registered people, alarm of face matching is output in real-time, and display an alarm history in the list.
- Specified screen image can be played back on control monitor with double-clicking on an alarm history.

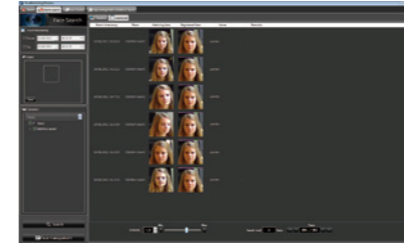

- People counting, Age and Gender Statistics**
- Count people of detected face and evaluate their age and gender
- Display the result on the screen with statistical graph
- The statistical data can be saved as a CSV file for analytical use.



**Basic System Connection Example**

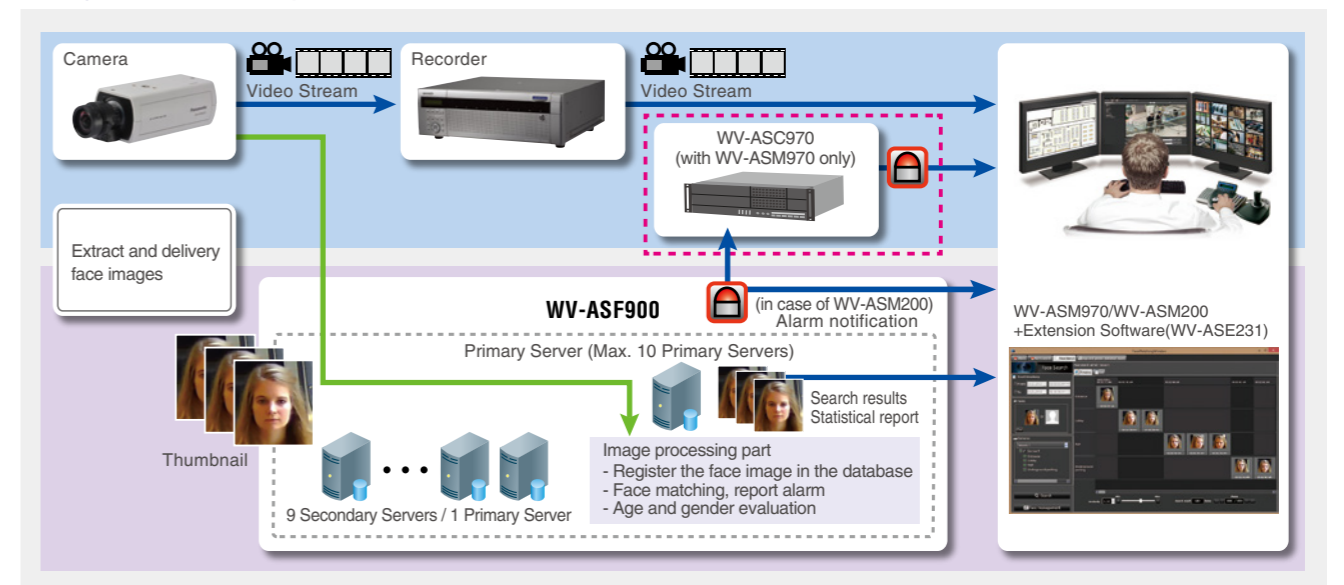

Extension software **WV-ASE231** for WV-ASM970 / WV-ASM200

- To use the WV-ASF900, WV-ASM970 or WV-ASM200 with extension software WV-ASE231 is required.
- Extension Software for Facial Recognition Analytics Platform (WV-ASF900)
- Face Matching / Face Search / People counting results display on WV-ASM970 / WV-ASM200 screen
- i-VMD (Intelligent Video Motion Detection) tracking path display on WV-ASM970 / WV-ASM200 screen

**Store** Medium-sized Supermarket Chain

**01 Reasons for Implementing System**

- Increasing numbers of shoplifting incidents were beginning to seriously affect store profitability.
- In particular, the impact of losses from habitual shoplifters was extremely high.
- When disagreements arose with customers over the amount of change received, no method of factual verification was available.
- There was a high risk of foreign object contamination of foods, and it was becoming increasingly difficult for this to be monitored by employees alone.



**02 Implemented System**

- Cameras were installed at the entrances and exits to the store. The faces of people coming in and out were recorded.
- The faces of habitual shoplifters were stored in the system from images of past shoplifting incidents.
- If a habitual shoplifter enters the store, the in-store music changes to a specific melody that warns all employees to be on alert.
- High-resolution Full HD cameras were installed on top of the cash registers for recording the exchange of money. If any problems arose, the types of bills used can be verified.
- Cameras were installed that overlook the shelves in each product aisle.



**03 Implementation Results**

- When a habitual shoplifter enters the store, all employees can immediately be made aware of and on alert for monitoring the potential scene of a crime.
- The facial images of shoplifters were also used to search for past images, allowing the collection of irrefutable evidence against repeat offenders.
- The face of the shoplifter was obtained from images of the shoplifting incident, and a search is conducted to monitor the actions of the shoplifter within the store. The data also provided confirmation of thefts made at other stores.
- When disagreements arise over the amount of change returned, the types of bills can be immediately verified using high-resolution video to allow any such problems to be resolved on the scene.
- Camera images were also shown on a large in-store display to ensure product and customer safety. This also led to fewer instances of shoplifting and other crimes, reducing the total amount of losses incurred.
- Both the near and far ends of products displayed on the shelves are shown in sharp detail for an even higher level of product safety than before.

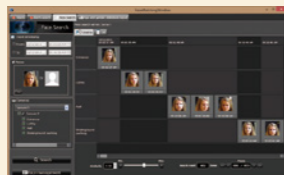

**04 Future Expansion**

- Because camera video enables the accurate capture of customer movement within the store, employees would like to use the security system to analyze the flow of customers on the store floor, along with customer gender, age, and other details to allow more efficient product arrangements and layouts.
- Management plans to implement identical systems throughout all stores in the supermarket chain and share information about habitual shoplifters to further reduce the amount of loss.



**Financial Institution** Bank

**01 Reasons for Implementing System**

- The currently-installed analog system had low-resolution images, and when a problem occurred, this video did not enable bank employees to precisely see what happened. In many locations, the faces of people could not be identified.
- The angle of view was narrow, and the coverage by a single analog camera was limited, resulting in many blind spots.
- A camera had to be installed in a low position to capture the face of the person operating the ATM, but mounting the camera within reach resulted in numerous cases of damage and defacement.
- The analog system only allowed confirmation of video from the control room within the premises.

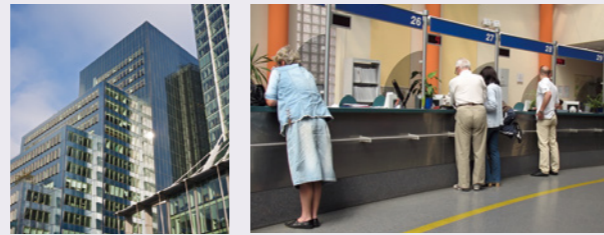

**02 Implemented System**

- Revamped the system with high-resolution network cameras.
- Retained usage of existing coaxial cable wiring and some analog cameras.
- Installed cameras with wide-angle lens and tamper-resistant structures at the ATMs.



**03 Implementation Results**

- The system provides a sharp image that enables a clear, detailed understanding of the situation.
- The faces of people entering the bank who are backlit from a bright outdoor environment can clearly be seen.
- Surveillance over a wide area is possible, and virtually all blind spots are eliminated.
- The existing equipment and wiring were used to provide a smooth IP migration process.
- Installation of vandal-resistant housings eliminated problems with broken cameras.



**Monitoring of Urban Areas** City Surveillance

**01 Reasons for Implementing System**

- Purse-snatching and other crimes have increased on city streets, and there have been growing calls from residents for the installation of security cameras.
- Increased number of incidents of cars, motorcycles, and other vehicles entering vehicle-prohibited zones, driving in the opposite direction on one-way streets, and other problems.
- Damage, defacing, and stealing of road signs, street lights, and other public property has required tremendous expenditures of funds for restoration.
- Illegal entry into restricted areas.
- Stalls were being opened on streets without permission, hindering the passage of people, and resulting in numerous complaints.
- Groups of young people were taking over open spaces for skateboarding and other activities, exposing young children playing in the area to danger.
- Safe management of children walking to school along the road was required.

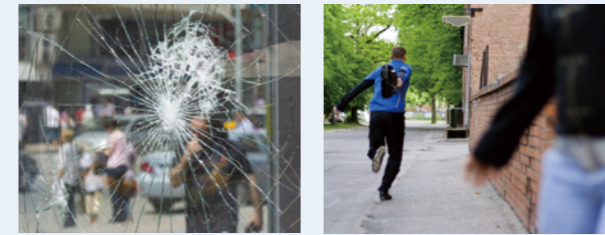

**02 Implemented System**

- PTZ cameras, 360-degree cameras, dome cameras, and box cameras were combined to build a surveillance environment without any blind spots.
- Rain-wash coated models were used for PTZ cameras that were directly exposed to rain and snow. This prevented any hindrance to monitoring during bad weather.
- Coaxial LAN converters were used for camera locations that were 100 meters or farther from a LAN port. Coaxial cables were connected to cameras at distances of up to 500 meters, and power was also supplied.
- Camera intelligent functions were used to automatically detect intrusion into restricted areas.
- If areas existed that were prohibited to be within the field of view of the security camera, privacy masks were applied to limit monitoring and recording to the specific areas allowed.

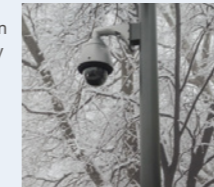

**03 Implementation Results**

- Enabled monitoring over a wide area and at high resolutions, and simplified the process of determining the causes of any problems.
- Installation of cameras on city streets had an effect on reducing crime, and the number of criminal incidents fell sharply.
- Camera intelligent functions are used to automatically issue an alarm whenever someone enters a restricted area, or tries to drive on a one-way street in the wrong direction. This enables the situation to be quickly assessed and proper corrective measures to be immediately taken.
- Allowed camera installations in locations where it was not possible before due to power supply or cable length problems.
- Use of weatherproof cameras enabled installation in all required locations without the worry of changing weather or seasons.
- This system enabled city residents to recognize the positive effects of security cameras that also take privacy into consideration.

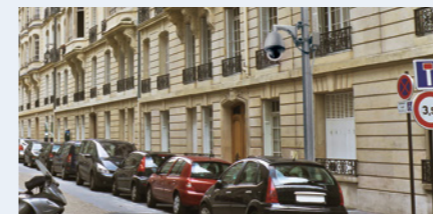

**Educational Institution** High Schools

**01 Reasons for Implementing System**

- Instances of suspicious intruders entering school grounds and committing crimes have been reported in the news, and there have been growing concerns and calls for greater safety by students, parents, and teachers.
- It is difficult to keep an open environment at the school while also ensuring the safety of students and school staff.
- Stealing and damage of equipment on school grounds.
- Numerous instances of damage to installed cameras and other destructive actions.



**02 Implemented System**

- 360-degree cameras were installed in all classrooms. The system is configured so that monitoring is not performed during normal classes, and recording is started only when a problem occurs.
- When a button attached to a teacher's infrared wireless microphone is pressed, an alarm is issued, the camera lens opens, and recording is started.
- Locations on school grounds identified as blind spots are constantly monitored and recorded by cameras.
- 24-hour monitoring and recording is performed at locations such as the school gate, areas where people and cars enter and leave, and at fences that can be scaled by intruders.
- The i-PRO Management System is installed in the control room to provide centralized control of the cameras and recorder.



**03 Implementation Results**

- Provided a high-security system while also protecting the privacy of students and teachers in the classroom.
- Suspicious intruders are detected by camera, and administrators are notified. A camera icon flashes on the map at the trouble locations for easy identification of problem spots over expansive school grounds.
- Tampering, graffiti, and other damage to school equipment were dramatically reduced.



New Products  
Function Introduction  
Network Camera Comparison Chart  
PTZ  
Fixed Dome  
360-degree Dome  
Box  
Pan/Tilt  
Network products  
Other

New Products  
Function Introduction  
Network Camera Comparison Chart  
PTZ  
Fixed Dome  
360-degree Dome  
Box  
Pan/Tilt  
Network products  
Other

### System Example

#### Small System

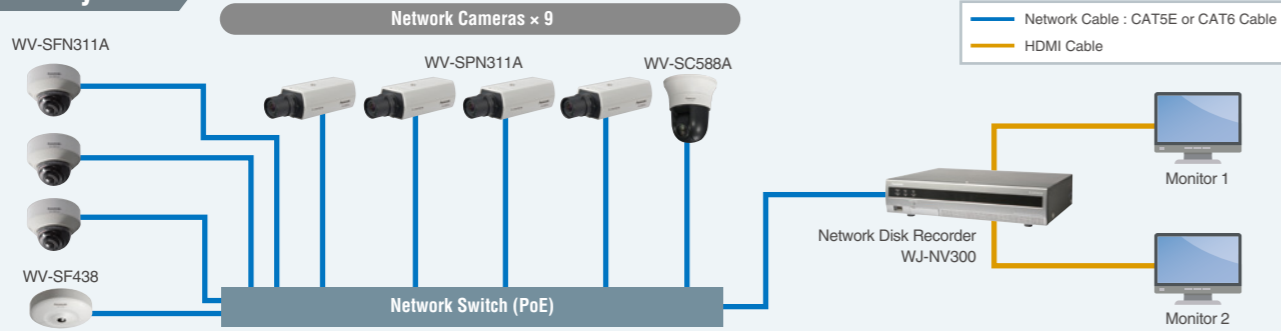

#### Middle size System

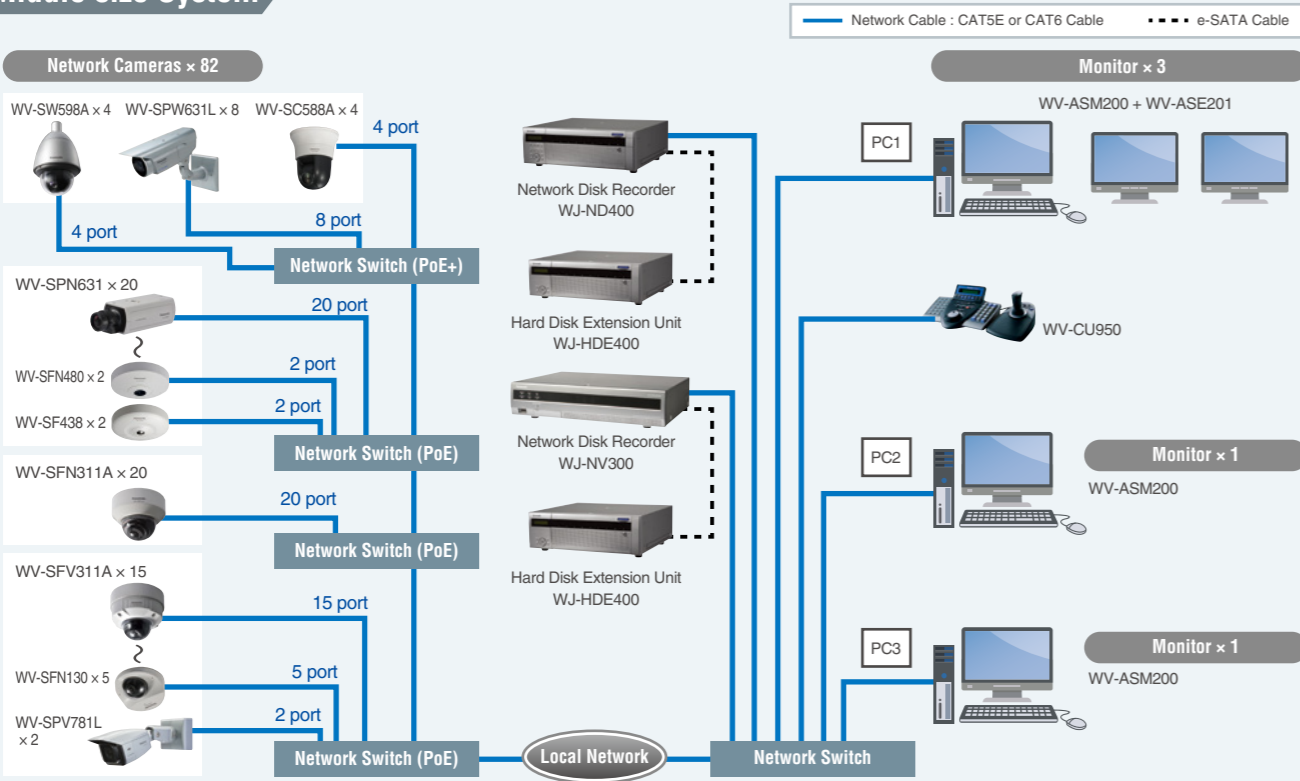

#### Face Matching / Search System

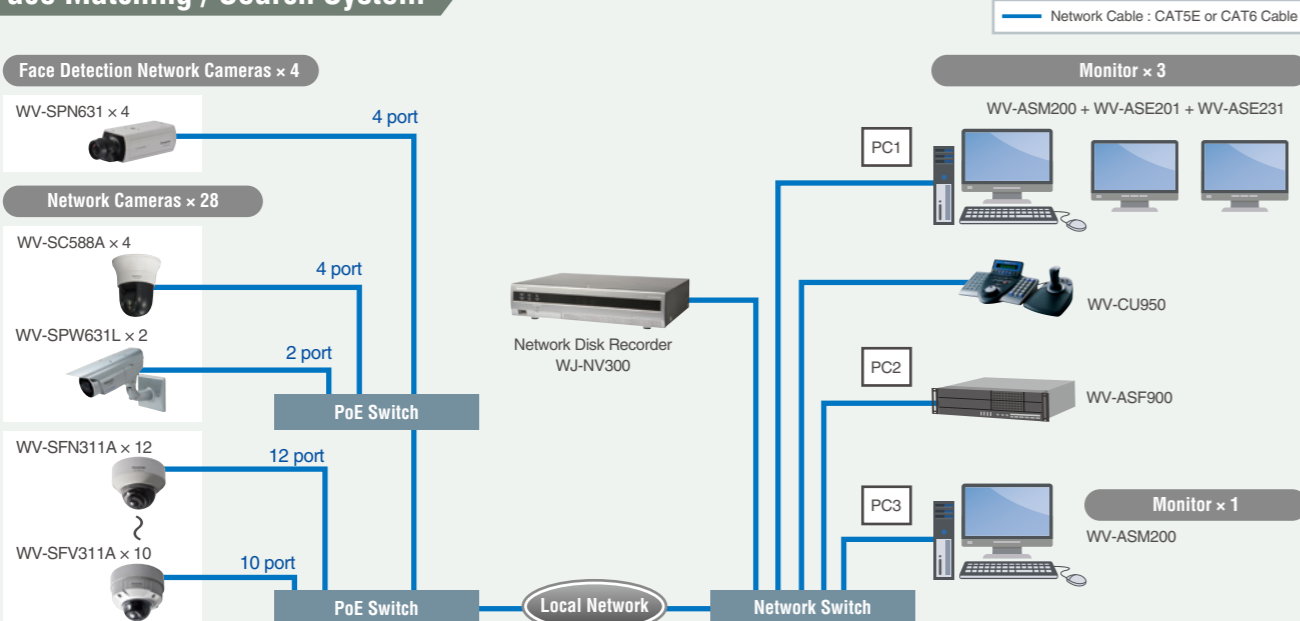

### System Example

#### Large Hybrid System

