

Panasonic®

Operating Instructions Basic Guide

360 degree camera speakerphone For business use

Model No.

TY-CSP1

Thank you for purchasing the Panasonic product.

Read this first.

Read the "Operating Instructions - Functional Manual" for detailed descriptions about the product and how to use it.

Refer to the following URL for information about how to download the "Operating Instructions - Functional Manual":
<https://panasonic.net/cns/prodisplays/>

- Please read these instructions before operating this product and retain them for future reference.
- **Be sure to read "Safety Precautions" (page 2 to 4) before use.**

English

PressIT360

AV0522GU1063 -FJ

Safety Precautions	2
Operating precautions	5
Accessories	8
Part Names	9
Connection	10
Configuring the applications on the PC	13
Operations with the buttons on the main unit	15
Video display modes	16
Indicator displays	19
Notes on the application	20
Installation	21
Specifications	22

DPQX1636ZB/X1

Safety Precautions

WARNING:

Stop using the product immediately when an abnormality or malfunction occurs.

Remove the power plug in the case of an abnormality.

- Smoke is emitted, or abnormal smell or sound occurs.
- Video or audio is not reproduced in some cases.
- Liquid such as water or a foreign object has entered inside the product.
- The product is deformed or damaged.

Using the product in such states may cause a fire or electric shock.

- Remove the power plug from the outlet and request repair to the dealer where you purchased the product.
- It is necessary to remove the power plug to completely turn off the power of this product.
- Do not repair the product by the customer since it is dangerous.
- Use an outlet located at a position where the hand can reach easily so that the power plug can be removed quickly.

Do not insert foreign objects into the product.

Do not insert or drop metals or flammable items into the inside the product.

Doing so may cause a fire or electric shock.

- Keep an eye on children in particular.

■ About AC adaptor

Do not use an AC adaptor other than those supplied with this product.

Using an AC adaptor other than those supplied may cause an electric shock or fire due to short circuit or heat generation.

Clean the power plug periodically to prevent dust from accumulating.

Failure to do so may cause a fire or electric shock due to moisture.

- Remove the power plug and wipe it with dry cloth.

Do not insert or remove the power plug with wet hand.

Doing so may cause an electric shock.

Do not use the outlet or wiring devices exceeding rated values or with currents other than 100 – 240 V AC.

Using them exceeding rated values by connecting too many plugs in one outlet may cause a fire due to heat generation.

Insert the power plug securely to the end.

Insufficient insertion may cause a fire due to an electric shock or heat generation.

- Do not use the product with a damaged plug or loose outlet.

Do not damage the AC adaptor and power plug.

(by damaging, modifying, forcibly bending, twisting, pulling or bundling them, bringing them close to heat appliances, placing heavy items on them, etc.)

Doing so may cause a fire or electric shock due to short circuit or disconnection.

- Request the dealer for repair of the AC adaptor or power plug.

Do not use the product while touching it for a long time.

Touching the hot parts of the product and AC adaptor for a long time may cause a low-temperature burn*.

- * Persons with poor bloodstream (due to vascular impairment, poor blood circulation, diabetes or strong compression) or poor skin sensitivity (elderly persons) tend to get a low-temperature burn.

Do not touch the product and AC adaptor if it begins to thunder.

Doing so may cause an electric shock.

Do not wet the product.

Doing so may cause a fire or electric shock.

Do not place the product on unstable locations.

Placing the product on a shaky table or an inclined location may cause an injury due to falling over or dropping.

Do not try to disassemble or modify the product.

CAUTION:

Do not place the product at a high-temperature location, humid or dusty location, or location subject to oil smoke or steam (such as a cooking table and humidifier).

Doing so may cause a fire or electric shock.

Do not drop the product or expose it to strong impacts.

Doing so may cause injury or fire.

When the product has been mounted on a tripod, do not move by holding this product.

The mounting parts can break due to the weight of the tripod and injury can result.

When removing the connection cables, be sure to hold the connector and pull it.

Pulling the cord may damage the cord, resulting in a fire due to an electric shock or short circuit.

When transferring the product, remove the connection cables of equipment beforehand.

Failure to do so may damage the cord or product, resulting in a fire or electric shock.

When not using the product for a prolonged period, remove the power plug from the outlet.

Dust may accumulate in the power plug, resulting in a fire or electric shock.

Safety Precautions Continued

Do not pull or hang the connection cables.

Doing so may cause the product to fall over or drop, resulting in an injury.

- Keep an eye on children in particular.

■ **Maintenance**

For maintenance, remove the power plug from the outlet for safety.

Failure to do so may cause an electric shock.

Operating precautions

■ When transporting this product

Do not apply excessive vibrations or impacts during transport.

Doing so may damage the internal parts, resulting in a malfunction.

■ To ensure a stable performance in the long term

Using the unit for prolonged periods in locations where the temperature and humidity levels are high will cause its parts to deteriorate, resulting in a reduction of its service life.

(Recommended temperature: Max. 35 °C (95 °F))

Ensure that a cooling unit or heating unit will not blow any air directly toward the installation location.

■ Operating temperature range

Avoid using the unit in cold locations where the temperature drops below 0 °C (32 °F) or hot locations where the temperature rises above 40 °C (104 °F) since these temperatures downgrade the picture quality and adversely affect the internal parts.

■ When storing the unit

Store indoors in a dry location.

■ When the unit is not in use

Turn off the unit's power when it is not in use.

When the unit is no longer going to be used, do not leave it lying around, but be absolutely sure to dispose of it properly.

■ Do not touch the optical system parts.

Under no circumstances must they be touched.

In the unlikely event that they have become dusty, remove the dust by using a camera blower or by wiping them gently with a lens cleaning paper.

■ Do not point the camera at strong lights.

When parts of the MOS sensor are exposed to spotlights or other strong lights, blooming (a phenomenon where the edges of strong lights become blurred) may occur.

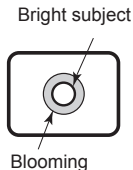

■ **What happens with high-brightness subjects**

Flare may occur if an extremely bright light source is pointed at the lens. In a case like this, change the angle or take some other remedial action.

■ **Note regarding image distortion**

Edges of the image will be distorted due to the characteristics of the lens.

■ **Do not point the camera directly at the sun or a laser beam no matter whether it is turned on or not.**

Taking images of the sun, laser beams, or other brightly lit subjects for prolonged periods of time may damage the CCD.

■ **Keep the unit away from water.**

Do not splash water onto the product. Otherwise, problems may occur.

■ **Do not swing the main unit around.**

■ **It is not recommended to install upside down.**

■ **Do not use at loud volumes over long periods. Also check that the volume on the PC is not too loud before connecting.**

There is a danger of hearing damage. Furthermore, the power turns on when you connect, and if a loud noise is emitted, there is a danger of hearing damage.

■ **Cleaning and maintenance**

Ensure that you unplug the AC adaptor from the outlet, then disconnect the power supply cable and the USB cable before proceeding.

Gently wipe the surface of the case by using a soft cloth to remove dirt.

- To remove stubborn dirt or fingerprints, dampen a cloth with diluted neutral detergent (1 part detergent to 100 parts water), wring out the cloth firmly, and then wipe away the dirt. Finally, wipe away all the moisture with a dry cloth.
- If water droplets get inside the unit, operating problems may result.

Usage of a chemical cloth

- Follow the instructions for the chemical cloth.

Avoid contact with volatile substances such as insect sprays, solvents and thinner.

- This may cause damage to the case or cause peeling of the paint. Furthermore, do not leave it in contact with a rubber or PVC substance for a long time.

Note when using alcohol

- Soak a small amount of alcohol at a concentration of 60 % or less in a soft cloth and wipe the housing. Then be sure to use a dry cloth to wipe it.
Note that wiping the housing with a hard cloth or rubbing it strongly may cause damage. Also, do not allow water droplets to enter the inside to prevent malfunction. Do not directly spray alcohol.
- Do not use antiseptic solutions other than alcohol.

■ Disposal

When disposing the product, ask your local authority or dealer about the correct methods of disposal.

■ Power for this product

There is no power switch on this product.

Turn off the power as follows:

- When supplying power with the USB Type-C to USB Type-C cable

Hold the plug of the cable on the PC side to unplug first, then hold the plug on the product side to unplug.

- When supplying power with the AC adaptor
Unplug the AC adaptor first from the outlet, then hold the plug on the product side to unplug.

Accessories

Check that you have the accessories and items shown.

AC adaptor (DPVF4350ZA/X1)..... 1
(including 3 conversion plugs)

USB Type-C to USB Type-C cable
(Approx. 1.0 m) (DPVF4351ZA/X1) 1

USB Type-C to USB Type-A cable
(Approx. 1.8 m) (DPVF4352ZA/X1) 1

Attention

- Store small parts in an appropriate manner, and keep them away from young children.
- The part numbers of accessories are subject to change without notice.
(The actual part number may differ from the ones shown above.)
- In case you lost accessories, please purchase them from your dealer. (Available from the customer service)
- Dispose the packaging materials appropriately after taking out the items.

Note

- This product and the cables included do not support output of images and audio using the Alternate Mode.

Part Names

■ On the 360 degree camera speakerphone

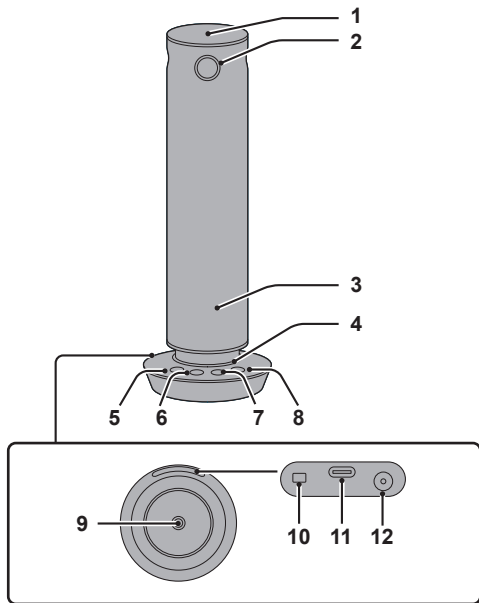

1 Microphone

Attention

- Do not block the microphone hole as this may cause a reduction in performance.

2 Cameras (4 facing 4 directions)

3 Speaker

4 Indicator

5 Audio muting button

6 Speaker volume [-] button

7 Speaker volume [+] button

8 [Mode] button

9 Camera mounting screw hole (screw: 1/4-20UNC)

Used when mounting on a tripod, etc.

10 Security slot

You can connect a security cable that is compatible with Noble Wedge slots with mounting surfaces of 11 mm ϕ or less.

11 USB-C terminal

Outputs video and audio to the PC. It also receives power supplied from the Type-C interface of the Listed PC (5 V/3 A).

12 Power input terminal

Connect the AC adaptor.

Connection

Carefully read the operating instructions of the PC to be connected to this product before connecting.
Turn off the power of each device before connecting cables.

Connections with this product

- 1 Connect the PC and this product with the supplied USB cable.
- When connecting via a USB Type-C port on a PC capable of supplying 5 V/3 A power
 - Only the supplied USB Type-C to USB Type-C cable can be used.

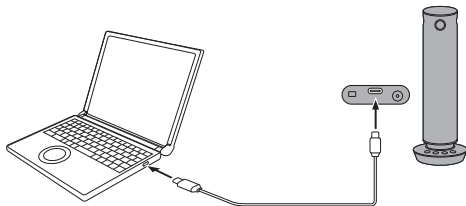

USB Type-C to USB Type-C cable

Note

- When using only the USB Type-C to USB Type-C cable, volume output is limited compared to when the AC adaptor is used.

■ When other connections are used

Use the AC adaptor to supply power.

<Get the AC adaptor ready>

Use by inserting the conversion plug into the supplied AC adaptor.

- ▶ Use the conversion plug that suits your outlet's shape.

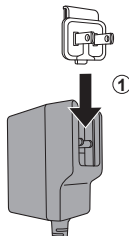

- ① Slide and press in the direction indicated by the arrow until you hear the click.

<How to remove the conversion plug>

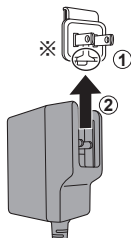

- ① While pressing the part marked ※ ,
- ② Slide in the direction indicated by the arrow to remove.

Note

- Do not attempt to separate the AC adaptor and the conversion plug while plugged into the outlet.
- Do not plug the conversion plug into the outlet on its own.

- ① Connect the DC plug of the AC adaptor to the power input terminal on this product, then plug the AC adaptor into the outlet.
- ② Connect the PC to this product using the supplied USB cable.

USB Type-C to USB Type-C cable
or
USB Type-C to USB Type-A cable

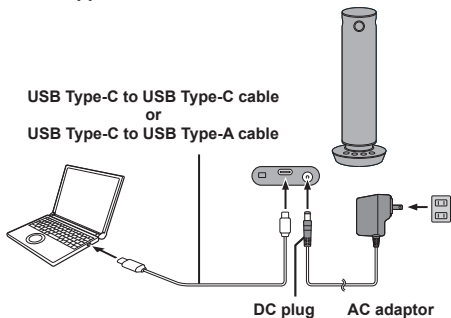

Note

- USB Type-C is labeled as “USB-C” on the main unit.

2 Start the online meeting application or camera application on your PC to show the video and play the audio from this product.

- For details on how to use this product with your online meeting application or camera application, refer to the operating instructions for the application.

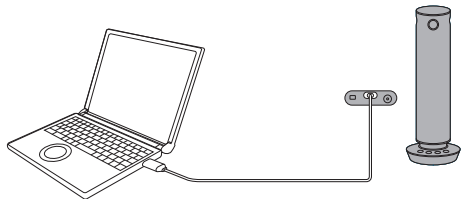

Configuring the applications on the PC

This section describes how to configure the online meeting application on your PC.

1 Connect this product to a PC.

(→ page 10)

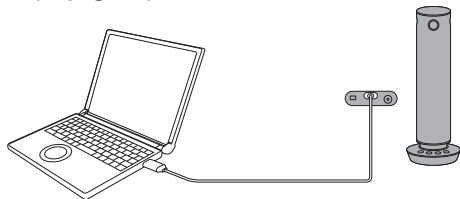

2 In the application, set this product as the camera, microphone, and speaker.

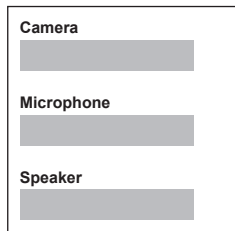

* Example configuration screen for your application

- If this product does not appear as a choice
 - Also connect the AC adaptor when connected only to the USB-C terminal.
- 3 Use the test feature of the application (if there is one) to run a test of the product's operations.
- 4 Start using the application after you have completed the test.

■ If the functions did not work properly when tested

- If the camera images are not output, see whether the camera muting function of the application is off.
- If sound is not output from the speaker, check whether the speaker volume is correct and if the speaker is on.
- If the microphone audio is not heard, see whether the microphone muting function of the application is off.

Operations with the buttons on the main unit

Muting the microphone

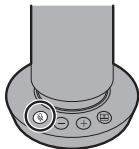

Muting is switched on or off each time you press [].

This works in conjunction with the muting features of some online meeting applications.

Adjusting speaker volume

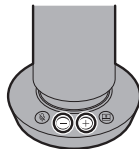



[-]: Lowers the volume.

[+]: Raises the volume.

This works in conjunction with the volume adjusting features of some operating systems and online meeting applications.

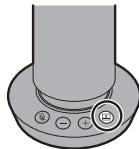
Changing the mode for displaying video



Press or press and hold [] to switch the video mode. (→ page 16)

Video display modes

Dual View



Use when you want to show the whole conference room, while making sure the facial expressions and voice of the speaker are clear.

Single View



Use when you want to show the face of the speaker at the maximum when conducting online meetings, etc., even if each screen is small.

Multi View

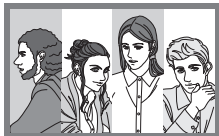

Use when you want to enlarge the faces of the participants.

Surround View



The 360 degree overall view is split into 2 screens of 180 degrees each.

Use when you want to show the expressions on the faces of all participants and give a feel for the atmosphere of the entire meeting room.

Stable View

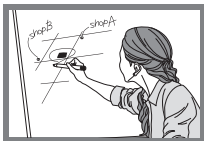

Use when you want to use the product as a web camera with a fixed position.

- The video from only one of the four camera screens is displayed. The video from the camera on the side with the buttons on this product is displayed.

Transition of the display modes

When you press the [Mode] button, the modes transition in the order “Dual View” → “Single View” → “Multi View” → “Surround View”.

When you press and hold the [Mode] button for 3 seconds or more, the mode transitions to the “Stable View”.

Press the [Mode] button to cancel the “Stable View”.

Pressing the [Mode] button to switch modes

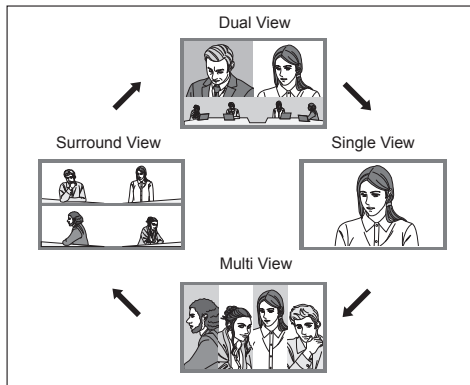

Pressing and holding the [Mode] button for 3 seconds or more

Pressing the [Mode] button

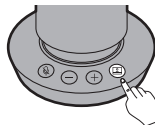

Indicator displays

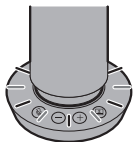

Preparing to start up
Red LED blinks
(Blinks about 10 times in
10 seconds)

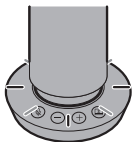

Updating firmware
Red LED blinks slowly
(Blinks about 5 times in
10 seconds)



Device error
Red LED blinks rapidly
(Blinks about 20 times in
10 seconds)

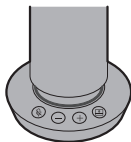

Normal circumstances (camera
and microphone on)
Green LED

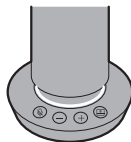

Camera off
White LED

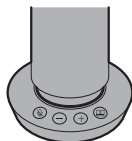

Microphone is muted
Red LED

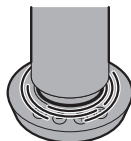

Camera off and microphone
is muted
(Red LED circulates)

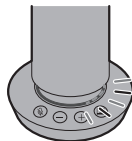

The gradation of the green LED changes only in the direction of
the speaker's voice.

* This may not work in some modes.

Notes on the application

Operations available with the PC application

The application in this product can perform the following tests and configurations, etc., when installed on a PC:

- Viewing the version on the main unit
- Displaying the video from the cameras
- Controlling the video (zooming in and out, moving up, down, left, and right)
 - * This may not work in some modes.
- Adjusting video quality
- Testing camera and speaker operation
- Updating firmware of the main unit

Note

- For application details and usage instructions, refer to the Operating Instructions - Functional Manual.
- The PC application is supported on the Microsoft Windows (Windows 10/Windows 11), and macOS operating systems.

Getting the installer

- 1 When you connect the product to a PC, “PressIT360” appears in the list of devices and drives.**

- 2 When you open the PressIT360 drive, the installer is saved to your PC.**
- 3 By running the installer, the PC application is installed on your PC.**

Note

- If there are cases where you are unable to access the product as a USB memory device, such as due to PC settings or security policies, etc., download the application from the following location:
<https://panasonic.net/cns/prodisplays/>

Installation

Installing on a table

Place this product on a flat, horizontal location.

Attention

- Install this product in a stable location where it will not be shaken. The video will shake if the location where the product is installed shakes.
- Take precautions to make sure the product does not fall and get damaged while you are installing it.
- Take care not to pull on the connected cables. This can cause the product to fall and may cause injury.

Take precautions to make sure the product does not fall.

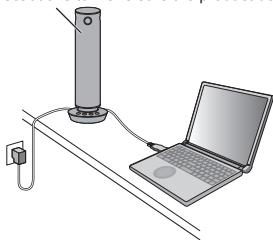

Mounting on a tripod

Mount the product on a tripod using the screw hole in the base of the product. Place the tripod on a flat, horizontal location.

Turn the screw to securely fix the tripod to this product. Use a tripod that has a screw that meets the following specifications:

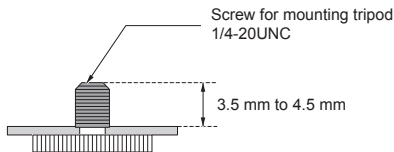

Attention

- Do not install the unit where people will be passing back and forth.
- When using the unit mounted on a tripod, do not put the tripod high above the floor level.
- Mount the unit securely so there is no looseness. Looseness can cause the unit to fall and may cause injury.
- When using over long periods, take precautions to prevent toppling or falling. Pack the product away as soon as you can after you have finished using it.

Specifications

■ Main unit

Model No.	TY-CSP1
Product name	360 degree camera speakerphone
Model No.	TY-CSP1
Imaging element	1/2.7" 5MP CMOS
Field of view	360(H) × 60(V)
F number of the lens	2.5
Lens TTL	14.7 mm
Distortion	-14.9 %
Microphone	MEMS Microphone array
Number of microphones	7
Beam forming	Supported
Microphone sensitivity	-35 dBFS
S/N ratio	68.75 dBA
Speaker output	1.5 W (When supplying power from USB Type-C) or 3 W (When AC adaptor is connected)
Connection terminals	USB Type-C (Receptacle/USB2.0) DC plug 12 V/2 A
Power supply	USB Type-C (5 V/3 A) or AC adaptor DC 12 V/2 A
Power consumption (when outputting video)	11 W

Dimensions (Φ × H)	Φ64 mm × 285 mm/ Φ2.52" × 11.23" (Operation base Φ100 mm (Φ3.94"))
Mass	950 g/2.1 lbs
Operating condition	Temperature: 0 °C to 40 °C (32 °F to 104 °F) Humidity: 20 % to 80 % (no condensation)
Usable altitude range	0 m to 2800 m/ 0 ft to 9186 ft

Software License

This product incorporates the following software:

- (1) the software developed independently by or for Panasonic Connect Co., Ltd.,
- (2) the software owned by third party and licensed to Panasonic Connect Co., Ltd.,
- (3) the software licensed under the GNU General Public License, Version 2.0 (GPL V2.0),
- (4) the software licensed under the GNU LIBRARY General Public License, Version 2.0 (LGPL V2.0),
- (5) the software licensed under the GNU LESSER General Public License, Version 2.1 (LGPL V2.1), and/or
- (6) open source software other than the software licensed under the GPL V2.0, LGPL V2.0 and/or LGPL V2.1.

The software categorized as (3) - (6) are distributed in the hope that it will be useful, but WITHOUT ANY WARRANTY, without even the implied warranty of MERCHANTABILITY or FITNESS FOR A PARTICULAR PURPOSE. For details, see the license conditions displayed by selecting [Software licenses], following the specified operation from the Web setting screen of this product.

At least three (3) years from delivery of this product, Panasonic Connect Co., Ltd. will give to any third party who contacts us at the contact information provided below, for a charge no more than our cost of physically performing source code distribution, a complete machine-readable copy of the corresponding source code covered under GPL V2.0, LGPL V2.0, LGPL V2.1 or the other licenses with the obligation to do so, as well as the respective copyright notice thereof.

Contact Information:

oss-cd-request@gg.jp.panasonic.com

FCC STATEMENT

This equipment has been tested and found to comply with the limits for a Class B digital device, pursuant to Part 15 of the FCC Rules. These limits are designed to provide reasonable protection against harmful interference in a residential installation. This equipment generates, uses and can radiate radio frequency energy and, if not installed and used in accordance with the instructions, may cause harmful interference to radio communications.

However, there is no guarantee that interference will not occur in a particular installation. If this equipment does cause harmful interference to radio or television reception, which can be determined by turning the equipment off and on, the user is encouraged to try to correct the interference by one or more of the following measures:

- Reorient or relocate the receiving antenna.
- Increase the separation between the equipment and receiver.
- Connect the equipment into an outlet on a circuit different from that to which the receiver is connected.
- Consult the dealer or an experienced technician for help.

FCC CAUTION:

To assure continued compliance, follow the attached installation instructions and use only the provided power supply cord. Any changes or modifications not expressly approved by Panasonic Corp. of North America could void the user's authority to operate this device.

Supplier's Declaration of Conformity

Model No.

TY-CSP1

Responsible Party:

Panasonic Corporation of North America
Two Riverfront Plaza, Newark, New Jersey
07102-5490

Contact Source:

Panasonic Connect North America
1-877-655-2357

General Contact:

<http://shop.panasonic.com/support>

This device complies with Part 15 of the FCC Rules and all applicable IC RSS standards. Operation is subject to the following two conditions: (1) This device may not cause harmful interference, and (2) this device must accept any interference received, including interference that may cause undesired operation.

PANASONIC PROFESSIONAL DISPLAY Limited Warranty

Models or Parts	Part Warranty	Labor Warranty
All Professional Display Model	3 Years	3 Years
Exceptions		
All Panasonic accessories: e.g. mounting kit, input signal module, cables, remote control, filter, batteries.	1 Year	1 Year

Panasonic Connect North America (referred to as “the Panasonic”) will repair the Professional Video product (the “Product”) and its accessories as defined in the attached table, with new or refurbished parts, free of charge in the continental USA, during the applicable warranty coverage period from the original date of purchase in the event of a defect in materials or workmanship as follows: On-Site, carry-in, or mail-in service within the **continental USA** may be obtained during the warranty period by contacting Panasonic’s Technical Support Center at the following toll free number **855-772-8324** or via

e-mail; ProDisplaySupport@us.panasonic.com. In case of mail-in service the customer is responsible for the cost of delivering of the Product to Panasonic’s facility, while Panasonic will pay for the return transportation of the repaired Product to the customer. For out of warranty Product units submitted for repairs or for in warranty units submitted by customers outside of the continental USA, shipping arrangements and cost (both ways) are the customer’s responsibility.

Panasonic will also not be responsible for any costs associated with determining the source of system problems or for removing and installing the faulty Product.

This warranty is extended only to the original purchaser and is nontransferable. A purchase receipt or other proof of date of original purchase will be required before warranty service is rendered. Whenever the date of original purchase cannot be satisfactorily determined, the date of manufacture of the unit will be deemed to be the effective date of the warranty. Panasonic reserves the right to audit and reject any warranty claim that cannot be substantiated. This warranty only covers failures due to defects in materials or workmanship which occur during normal use of the Product.

The warranty **DOES NOT** cover damage to the display and its components which occur in shipping; failures which are caused by products not supplied by Panasonic; failures which result from accident, misuse, abuse, neglect, mishandling, misapplication, alteration, modification, faulty installation, setup adjustments, improper antenna, inadequate signal pickup, maladjustment of user controls, improper operation, power line surge, improper voltage supply, lightning damage, smoke or chemical vapors contamination, air conditioning, humidity control or other environmental conditions; failure to maintain the product in accordance with the applicable Operating Instructions; service by anyone other than an authorized repair facility; damage that is attributable to acts of violence, war, acts of God or force majeure.

The warranty does not cover damage which occurs to the display or its components caused by excessive continual usage which goes beyond the operational time described in the Operating Instructions.

The warranty does not cover units of which the model and serial number label has been defaced, modified, tampered with or removed. The warranty does not cover consumable parts.

LIMITS AND EXCLUSIONS

PANASONIC SHALL NOT BE LIABLE FOR ANY INDIRECT, INCIDENTAL, CONSEQUENTIAL, PUNITIVE OR SPECIAL DAMAGES, INCLUDING, BUT NOT LIMITED TO, LOSS OF DATA, LOSS OF PROFIT, LOSS OF REVENUE, OR LOSS OF BUSINESS OR GOODWILL, SUFFERED BY ANY PERSON, AND RESULTING FROM THE USE OF THIS PANASONIC PROFESSIONAL DISPLAY PRODUCT, OR ARISING OUT OF ANY BREACH OF THIS WARRANTY. ALL EXPRESS WARRANTIES SPECIFIED ABOVE ARE IN LIEU OF ALL OTHER WARRANTIES, EXPRESS, IMPLIED OR STATUTORY, INCLUDING BUT NOT LIMITED TO, THE IMPLIED WARRANTIES OF MERCHANTABILITY AND FITNESS FOR A PARTICULAR PURPOSE

Some states do not allow the exclusion or limitation of incidental or consequential damages, or limitations on how long an implied warranty lasts, so the above limitations or exclusions may not apply to you.

If you have a problem with this product that is not handled to your satisfaction, then write the Consumer Affairs Department at the Panasonic's address indicated above.

Trademark Credits

- USB Type-C and USB-C are trademarks or registered trademarks of USB Implementers Forum.
- Microsoft® and Windows® are either registered trademarks or trademarks of Microsoft Corporation in the United States and other countries.
- macOS is a registered trademark of Apple Inc., in the United States and other countries.
- PressIT360 is a trademark of Panasonic Holdings Corporation.

Even if no special notation has been made of company or product trademarks, these trademarks have been fully respected.

Disposal of Old Equipment

Only for European Union and countries with recycling systems



This symbol on the products, packaging, and/or accompanying documents mean that used electrical and electronic products must not be mixed with general household waste.

For proper treatment, recovery and recycling of old products, please take them to applicable collection points in accordance with your national legislation.

By disposing of them correctly, you will help to save valuable resources and prevent any potential negative effects on human health and the environment.

For more information about collection and recycling, please contact your local authority.

Penalties may be applicable for incorrect disposal of this waste, in accordance with national legislation.

Notice (U.S.A. only)

Disposal may be regulated in your community due to environmental considerations. For disposal or recycling information, please visit Panasonic website:

<https://holdings.panasonic/global/corporate/sustainability.html>

or call 1-888-769-0149.

Panasonic Canada Inc.
5770 Ambler Drive, Mississauga, Ontario L4W 2T3
LIMITED WARRANTY STATEMENT

Panasonic Canada Inc. (also known as PCI) warrants this product to be free of defects in material and workmanship under normal use during the applicable warranty coverage period described below. PCI agrees to repair, or at its option, exchange, any part that becomes defective. However, the product must be purchased and serviced in Canada. The product or part that shows evidence of defect must be delivered prepaid or carried in to an authorized Panasonic Broadcast Service Center. This warranty does not cover shipping costs.

The warranty coverage period is one year for both parts and labour beginning with the date of original end user purchase, subject to the exceptions as stated below. Repaired or replacement parts supplied during the warranty coverage period carry the unexpired portion of the original warranty coverage period. Proof of product purchase is a condition of warranty service. The owner must produce the product purchase receipt or other satisfactory evidence of date of original purchase.

This warranty does not apply to external appearance items, such as handles, knobs, safety windows, etc. This warranty does not apply to any part, or parts, of the product, installed, altered, repaired or misused in any way that, in the opinion of PCI, affects the reliability of or detracts from the performance of the product.

For products requiring routine preventive maintenance, that maintenance must be performed in order to maintain warranty coverage.

Serial numbers that have been altered, defaced or removed void this warranty. This warranty does not cover replacements or repairs necessitated by loss or damage resulting from any cause beyond the control of PCI.

Marking or retained images (sometimes called "burn-in") resulting from the display of fixed images on video display products are not defects and are not covered under this warranty.

THIS EXPRESS, LIMITED WARRANTY IS IN LIEU OF ALL OTHER WARRANTIES, EXPRESS OR IMPLIED, INCLUDING ANY IMPLIED WARRANTIES OF MERCHANTABILITY AND FITNESS FOR A PARTICULAR PURPOSE. IN NO EVENT WILL PANASONIC CANADA INC. BE LIABLE FOR ANY SPECIAL, INDIRECT OR CONSEQUENTIAL DAMAGES.

In certain instances, some jurisdictions do not allow the exclusion or limitation of incidental or consequential damages, or the exclusion of implied warranties, so the above limitations and exclusions may not be applicable.

WARRANTY COVERAGE PERIOD EXCEPTIONS

Item	Parts	Labour
Video Tape	30 days—Replacement only (content not covered)	N/A
P2/SD Cards	(Content not covered)	N/A
Video Heads	1 year or 2,000 hrs. (prorated) Whichever comes first	1 year or 2,000 hrs. Whichever comes first
D5 Video heads	1 year or 1,000 hrs. Whichever comes first	1 year or 1,000 hrs. Whichever comes first
Maintenance Items	90 days	90 days
Colour Camera CCD Imaging Block	2 years	2 years
All LCD Monitors	2 years (burn-in not covered)	2 years
* DLP™ Projectors	3 years or 17,000 hrs. Whichever comes first	3 years or 17,000 hrs. Whichever comes first
* LCD Projectors above 2,500 ANSI Lumens	3 years or 2,500 hrs. Whichever comes first	3 years or 2,500 hrs. Whichever comes first.
* LCD Projectors below 2,500 ANSI Lumens	3 years or 1,500 hrs. Whichever comes first	3 years or 1,500 hrs. Whichever comes first
Projector Lamps	50% of the rated lamp life or 1 year. Whichever comes first	50% of the rated lamp life or 1 year. Whichever comes first.
All Plasma displays	2 years (burn-in not covered)	2 years
103 inch Plasma displays	3 years (burn-in not covered)	3 years
Hard Drive Disk Unit	1 year plus balance (if any) of the original Manufacturer's Limited Warranty. (Content not covered)	1 year

- Dust, smoke, rental/staging environment and twenty-four/seven operation, dramatically decreases the interval between performances of routine preventive maintenance required to maintain this warranty coverage.

Warranty Service

If the product needs to be shipped for service, carefully pack (preferably in the original carton) and enclose a letter, detailing the complaint. Send prepaid and adequately insured to the local authorized Panasonic Service Centre in your area or to Panasonic Technical Support and Product Services Department, 5770 Ambler Drive, Mississauga, Ontario, L4W 2T3. Shipping to the latter location requires a return authorization before shipment. No liability is assumed for loss or damage to the product while in transit.

Customer's Record

The model number and serial number of this product may be found on its rear panel. You should note this serial number in the space provided below and retain this book, plus your purchase receipt, as a permanent record of your purchase to aid in identification in the event of theft or loss, and for Warranty Service purposes.

Model Number

Serial Number

Panasonic Connect North America

Unit of Panasonic Corporation of North America

Executive Office :

Two Riverfront Plaza, Newark, New Jersey 07102

Panasonic Canada Inc.

5770 Ambler Drive, Mississauga, Ontario L4W 2T3

Authorized Representative in EU:

Panasonic Connect Europe GmbH

Panasonic Testing Centre

Winsbergring 15, 22525 Hamburg, Germany

Importer for UK:

Panasonic Connect UK,

a branch of Panasonic Connect Europe GmbH,

Maxis 2, Western Road, Bracknell, Berkshire, RG12 1RT

Panasonic Connect Co., Ltd.

4-1-62 Minoshima, Hakata-ku, Fukuoka 812-8531, Japan

Web Site: <https://panasonic.net/cns/prodisplays/>

© Panasonic Connect Co., Ltd. 2022

English

Printed in Taiwan