

Operating Instructions Functional Manual

DIGITAL LINK Switcher Commercial Use

Model No. **ET-YFB200G**

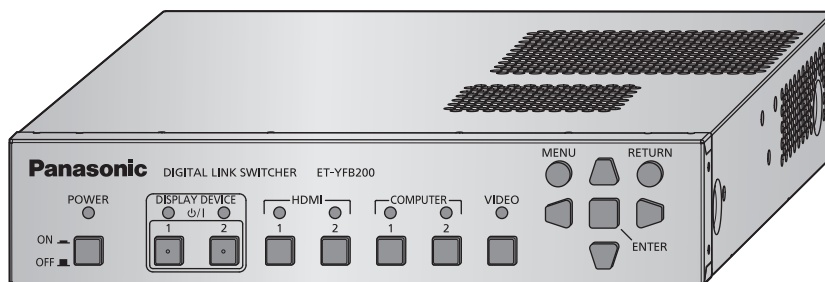

Thank you for purchasing this Panasonic product.

- Before operating this product, please read the instructions carefully and save this manual for future use.
- Before using this product, be sure to read “Read this first!” (➡ pages 4 to 8).

Contents

Read this first!	4	[INPUT SELECT] menu	41
		Switching the input	41
Chapter 1 Preparation		[PICTURE] menu	42
Precautions for use	12	[SYSTEM SELECTOR]	42
Cautions when transporting	12	[CLAMP POSITION]	42
Cautions when installing	12	[DIGITAL CINEMA REALITY]	43
DIGITAL LINK	13	[POSITION] menu	44
Early Warning Software	13	[SHIFT]	44
Disposal	13	[CLOCK PHASE]	44
Accessories	14	[OVER SCAN]	45
Optional accessories	15	[ASPECT]	45
About your device	16	[INPUT RESOLUTION]	45
Main body	16	[LANGUAGE] menu	47
		Changing the display language	47
Chapter 2 Getting Started		[OPTION] menu	48
Setting up	20	[ON-SCREEN SETTING]	48
Mounting on a rack	20	[COMPUTER IN]	48
Placing on a desk or a shelf	20	[HDMI IN]	50
Connecting	22	[DIGITAL LINK OUT]	52
Before connecting	22	[DVI-D OUT]	53
Connecting example: Image input device and audio device	23	[CLOSED CAPTION SETTING] (only when NTSC or 480i YC _B C _R signal is input)	54
Connecting example: Computers	24	[BACK COLOR]	55
Connecting example: Image display device	24	[NO SIGNAL SLEEP]	55
		[AUDIO SETTING]	55
Chapter 3 Basic Operations		[AUTO SETUP]	57
Turning on/off the device	30	[BACKUP INPUT SETTING]	57
Connecting the AC adapter	30	[RS-232C]	58
Turning on the power of the DIGITAL LINK Switcher	31	[NETWORK]	60
Turning off the power of the DIGITAL LINK Switcher	31	[STATUS]	61
Turning on/off the power of the display	32	[INITIALIZE]	62
Before turning off/on the power of the display	32	Chapter 5 Network control function	
Turning on the power of the display	33	Network connection	64
Turning off the power of the display	33	Connection example	64
Checking the image	34	Setting of the device	65
Selecting the image to display	34	Setting of the computer	65
Operating with the remote control	35	Using the web control function	66
Switching the input	35	Accessing from the web browser	66
Displaying the on-screen menu (main menu)	35	Using the browser remote control	73
		Displaying the browser remote control	73
Chapter 4 Settings		Description of items	74
Menu navigation	38	Chapter 6 Appendix	
Navigating through the menu	38	Maintenance	76
Main menu	39	Before maintenance	76
Sub-menu	39	Maintenance	76
		Troubleshooting	77
		Frequently Asked Questions	78

Contents

Technical information	79
PJLink protocol.....	79
Control commands via LAN.....	80
<SERIAL IN> terminal.....	83
<REMOTE IN> terminal.....	87
Compatible signals.....	88
Specifications	91
Dimensions	94
Index	96

Read this first!

WARNING: THIS APPARATUS MUST BE EARTHED.

WARNING:

1. Remove the plug from the mains socket when this unit is not in use for a prolonged period of time.
2. To prevent electric shock, do not remove cover. No user serviceable parts inside. Refer servicing to qualified service personnel.
3. Do not remove the earthing pin on the mains plug. This apparatus is equipped with a three prong earthing-type mains plug. This plug will only fit an earthing-type mains socket. This is a safety feature. If you are unable to insert the plug into the mains socket, contact an electrician. Do not defeat the purpose of the earthing plug.

WARNING:

This equipment is compliant with Class A of CISPR32.
In a residential environment this equipment may cause radio interference.

CAUTION: To assure continued compliance, follow the attached installation instructions, which include using the provided power cord and shielded interface cables when connecting to computer or peripheral device. If you use serial port to connect PC for external control of projector, you must use a commercial RS-232C serial interface cable with ferrite core. Any unauthorized changes or modifications to this equipment will void the user's authority to operate.

WARNING: TO REDUCE THE RISK OF FIRE OR ELECTRIC SHOCK, DONOT EXPOSE THIS PRODUCT TO RAIN OR MOISTURE.

Power Supply: This equipment is designed to operate on 100 V - 240 V, 50 Hz/60 Hz AC, house current only.

CAUTION: The AC power cord (for USA) which is supplied with the equipment as an accessory can only be used for power supplies up to 125 V. If you need to use higher voltages than this, you will need to obtain a separate 250 V power cord. If you use the accessory cord in such situations, fire may result.

CAUTION (USA and Canada)

This equipment is equipped with a three-pin grounding-type power plug. Do not remove the grounding pin on the power plug. This plug will only fit a grounding-type power outlet. This is a safety feature. If you are unable to insert the plug into the outlet, contact an electrician. Do not defeat the purpose of the grounding plug.

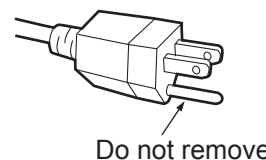

WARNING (USA and Canada)

- Not for use in a computer room as defined in the Standard for the Protection of Electronic Computer/Data Processing Equipment, ANSI/NFPA 75.
- For permanently connected equipment, a readily accessible disconnect device shall be incorporated in the building installation wiring.
- For pluggable equipment, the socket-outlet shall be installed near the equipment and shall be easily accessible.

NOTIFICATION (Canada)

This class A digital apparatus complies with Canadian ICES-003.

FCC NOTICE (USA)

Supplier's Declaration of Conformity

Model Number: ET-YFB200G
Trade Name: Panasonic
Responsible Party: Panasonic Corporation of North America
Address: Two Riverfront Plaza, Newark, NJ 07102-5490
General Contact: <http://www.panasonic.com/support>
Projector Contact: <https://panasonic.net/cns/projector/>

This device complies with Part 15 of the FCC Rules.

Operation is subject to the following two conditions:

(1) This device may not cause harmful interference, and (2) this device must accept any interference received, including interference that may cause undesired operation.

To assure continued compliance, follow the attached installation instructions and do not make any unauthorized modifications.

Caution:

This equipment has been tested and found to comply with the limits for a Class A digital device, pursuant to Part 15 of the FCC Rules. These limits are designed to provide reasonable protection against harmful interference when the equipment is operated in a commercial environment. This equipment generates, uses and can radiate radio frequency energy and, if not installed and used in accordance with the instructions, may cause harmful interference to radio communications. However, there is no guarantee that interference will not occur in a particular installation. If this equipment does cause harmful interference to radio or television reception, which can be determined by turning the equipment off and on, the user is encouraged to try to correct the interference by one or more of the following measures:

- Reorient or relocate the receiving antenna.
- Increase the separation between the equipment and receiver.
- Connect the equipment into an outlet on a circuit different from that to which the receiver is connected.
- Consult the dealer or an experienced radio/TV technician for help.

FCC Warning:

To assure continued compliance, follow the attached installation instructions and use only shielded interface cables when connecting to computer and/or peripheral devices. Any changes or modifications not expressly approved by Panasonic Corp. of North America could void the user's authority to operate this device.

IMPORTANT: THE MOULDED PLUG (U.K. only)

FOR YOUR SAFETY, PLEASE READ THE FOLLOWING TEXT CAREFULLY.

This appliance is supplied with a moulded three pin mains plug for your safety and convenience. A 13 amp fuse is fitted in this plug. Should the fuse need to be replaced, please ensure that the replacement fuse has a rating of 13 amps and that it is approved by ASTA or BSI to BS1362.

Check for the ASTA mark  or the BSI mark  on the body of the fuse.

If the plug contains a removable fuse cover, you must ensure that it is refitted when the fuse is replaced. If you lose the fuse cover, the plug must not be used until a replacement cover is obtained. A replacement fuse cover can be purchased from an Authorised Service Center.

If the fitted moulded plug is unsuitable for the mains socket in your home, then the fuse should be removed and the plug cut off and disposed of safely. There is a danger of severe electrical shock if the cut off plug is inserted into any 13 amp socket.

If a new plug is to be fitted, please observe the wiring code as shown below.

If in any doubt, please consult a qualified electrician.

WARNING: THIS APPLIANCE MUST BE EARTHED.

IMPORTANT: The wires in this mains lead are coloured in accordance with the following code:

Green - and - Yellow: Earth
Blue: Neutral
Brown: Live

As the colours of the wire in the mains lead of this appliance may not correspond with the coloured markings identifying the terminals in your plug, proceed as follows.

The wire which is coloured GREEN - AND - YELLOW must be connected to the terminal in the plug which is marked with the letter E or by the Earth symbol  or coloured GREEN or GREEN - AND - YELLOW.

The wire which is coloured BLUE must be connected to the terminal in the plug which is marked with the letter N or coloured BLACK.

The wire which is coloured BROWN must be connected to the terminal in the plug which is marked with the letter L or coloured RED.

How to replace the fuse: Open the fuse compartment with a screwdriver and replace the fuse.

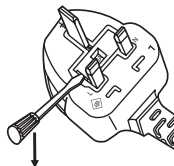

Importer's name and address within the European Union

Panasonic Marketing Europe GmbH

Panasonic Testing Centre

Winsbergring 15, 22525 Hamburg, Germany

WARNING:

■ POWER

The wall outlet or the circuit breaker shall be installed near the equipment and shall be easily accessible when problems occur. If the following problems occur, cut off the power supply immediately.

Continued use of the device in these conditions will result in fire or electric shock.

- If foreign objects or water get inside the device, cut off the power supply.
- If the device is dropped and the AC adapter is damaged, cut off the power supply.
- If you notice smoke, strange smells or noise coming from the device, or notice the device is overheating, cut off the power supply.

Please contact an Authorized Service Center for repairs, and do not attempt to repair the device yourself.

During a thunderstorm, do not touch the device, power cord, power plug, power connector or AC adapter.

Failure to observe this will result in electric shocks.

Do not do anything that might damage the power cord, power plug, power connector or AC adapter.

If the power cord is used while damaged, electric shocks, short-circuits or fire will result.

- Do not damage the power cord, make any modifications to it, place it near any hot objects, bend it excessively, twist it, pull it, place heavy objects on top of it or wrap it into a bundle.

Ask an Authorized Service Center to carry out any repairs to the power cord or AC adapter that might be necessary.

Completely insert the power plug into the wall outlet, the power connector into the AC adapter terminal, and the AC adapter plug into the device terminal.

If the plug is not inserted correctly, electric shocks or overheating will result.

- Do not use plugs which are damaged or wall outlets which are coming loose from the wall.

Do not use anything other than the provided AC adapter or power cord.

Please note that not using the provided power cord or AC adapter may result in fire or electric shocks caused by a short circuit or overheating.

Clean the power plug regularly to prevent it from becoming covered in dust.

Failure to observe this will cause a fire. If dust builds up on the power plug, the resulting humidity can damage the insulation.

- Pull the power plug out from the wall outlet and wipe it with a dry cloth regularly.
- When not using the device for an extended period of time, disconnect the power plug from the wall outlet.

Do not handle the power cord, power plug, power connector or AC adapter with wet hands.

Failure to observe this will result in electric shocks.

Do not overload the wall outlet.

If the power supply is overloaded (ex., by using too many adapters), overheating may occur and fire will result.

■ ON USE/INSTALLATION

Do not place the device on soft materials such as carpets or sponge mats.

Doing so will cause the device to overheat, which can cause burns, fire or damage to the device.

Do not set up the device in humid or dusty places or in places where the device may come into contact with oily smoke or steam, ex. a bathroom.

Using the device under such conditions will result in fire or electrical shock.

Do not block the exhaust ports or cover them with cloth, paper, etc.

Doing so will cause the device to overheat, which can cause fire or damage to the device.

- Set the device in a location where the intake ports and exhaust ports at the top and sides of the device will not be blocked.

Do not handle the device for extended lengths of time.

Parts of the device and/or AC adapter may become hot and cause low temperature burns* if handled for an extended length of time.

* Persons who suffer from blood complications (such as vascular diseases, diabetes, poor/restricted circulation) or with poor skin sensitivity (the elderly) are especially susceptible to low temperature burns.

Never attempt to remodel or disassemble the device.

High voltages can cause fire or electric shocks.

- For any inspection, adjustment and repair work, please contact an Authorized Service Center.

WARNING:

Do not allow metal objects, flammable objects, or liquids to enter inside of the device. Do not allow the device to get wet.

Doing so may cause short circuits or overheating, and result in fire, electric shock, or malfunction of the device.

- Do not place containers of liquid or metal objects near the device.
- If liquid enters inside of the device, consult your dealer.
- Particular attention must be paid to children.

■ **ACCESSORIES**

Keep accessories (screws, feet, and AC adapter securing bracket) out of the reach of small children.

Accidentally swallowing them can cause physical harm.

- If you believe that parts have been swallowed, seek medical advice immediately.

CAUTION:

■ **POWER**

When disconnecting the power cord, be sure to hold the power plug and power connector.

If the power cord itself is pulled, the lead will become damaged, and fire, short-circuits or serious electric shocks will result.

When not using the device for an extended period of time, disconnect the power plug from the wall outlet.

Failure to do so may result in fire or electric shock.

Disconnect the power plug from the wall outlet before carrying out any cleaning of the device.

Failure to do so may result in electric shock.

■ **ON USE/INSTALLATION**

Do not place heavy objects on top of the device.

Failure to observe this will cause the device to become unbalanced and fall, which could result in damage or injury. The device will be damaged or deformed.

Do not put your weight on this device.

You could fall or the device could break, and injury will result.

- Be especially careful not to let young children stand or sit on the device.

Do not install this device in a place which is not strong enough to take its full weight or on top of a surface which is sloped or unstable.

Failure to observe this will cause the device to fall down or tip over the device, and severe injury or damage could result.

Do not place the device in extremely hot locations.

Doing so will cause the outer casing or internal components to deteriorate, or result in fire.

- Take particular care in locations exposed to direct sunlight or near stoves.

Always disconnect all cables before moving the device.

Moving the device with cables still attached can damage the cables, which will cause fire or electric shocks to occur.

■ **ACCESSORIES**

Do not subject the AC adapter to strong impact.

The adapter being dropped, or suffering any other strong impact may cause a short circuit, fire or electric shock.

- Ask an Authorized Service Center to carry out repairs to the AC adapter.

■ Trademarks

- Windows, Windows Vista, and Internet Explorer are registered trademarks or trademarks of Microsoft Corporation in the United States and other countries.
- Mac, macOS, OS X, and Safari are trademarks of Apple Inc., registered in the United States and other countries.
- Trademark PJLink is a trademark applied for trademark rights in Japan, the United States of America and other countries and areas.
- The terms HDMI and HDMI High-Definition Multimedia Interface, and the HDMI Logo are trademarks or registered trademarks of HDMI Licensing Administrator, Inc. in the United States and other countries.
- HDBaseT™ is a trademark of HDBaseT Alliance.
- Adobe and Adobe Reader are trademarks or registered trademarks of Adobe Systems Inc., in the United States and/or other countries.
- Some of the fonts used in the on-screen menu are Ricoh bitmap fonts, which are manufactured and sold by Ricoh Company, Ltd.
- All other names, company names, and product names mentioned in this manual are trademarks or registered trademarks of their respective owners.
Please note that the ® and ™ symbols are not specified in this manual.

■ Illustrations in this manual

- Illustrations of the DIGITAL LINK Switcher or the screen may be different from the actual product.

■ Reference pages

- Reference pages in this manual are indicated as (➔ page 00).

■ Term

- In this manual, the “EIA standard rack” is referred to as the “Rack”.

Features of the device

Long-distance transmission with one cable

- ▶ This device is supporting the communication method “DIGITAL LINK”, which has added functions unique to Panasonic based on the communication standard “HDBaseT™” formulated by HDBaseT Alliance, and it can send image, audio, Ethernet, and serial control signals through one twisted pair cable of CAT5e or higher. By connecting to the DIGITAL LINK or the HDBaseT™ compliant display (projector or flat panel display) or receiver, it can perform long-distance transmission up to 100 m (328'1”).
- ▶ This device is also supporting the “long reach”, which is the communication method unique to Panasonic that can extend the transmission distance with the equipment connected with the DIGITAL LINK, and transmission up to 150 m (492'1”) is possible when connecting with a display that can perform the long reach communication. However, the image that can be transmitted is restricted to resolution of 1080/60p (dot clock 148.5 MHz) or less.

Various operation methods

- ▶ In addition to operating with the control panel of this device and the remote control of the display connected with the DIGITAL LINK, setting, adjustment, and status check can be performed by accessing this device from a computer connected to the network.
- ▶ Turning off/on the power of the display connected with the DIGITAL LINK can be performed by the control panel of this device or the web browser.

Supporting output to multiple displays

- ▶ In addition to 2 sets of output in the DIGITAL LINK, this device also supports the DVI-D output. Furthermore, it is possible to output video and audio signals with the DIGITAL LINK to 3 or more displays by performing cascade connection (multiple device connection) of this device. However, the misalignment of the displayed image or the played back audio may be obvious when the number of displays connected in cascade increases.

Chapter 1 Preparation

This chapter describes things you need to know or check before using this device.

Precautions for use

Cautions when transporting

- When transporting this device, avoid excessive vibration and impacts. Failure to do so may cause damage to internal components and result in malfunctions.

Cautions when installing

■ Do not set up the device outdoors.

The device is designed for indoor use only.

■ Do not set up the device in the following locations.

- Places where vibration and impacts occur such as in a car or vehicle: Doing so may cause damage to internal components or malfunction.
- Location close to sea or location where corrosive gas occurs: It may affect the life of the parts or malfunction.
- Near high-voltage power lines or near motors: Doing so may interfere with the operation of the device.

■ Do not install the device at elevations of 2 700 m (8 858') or higher above sea level.

Doing so may shorten the life of the components and result in malfunctions.

■ Do not block the air intake port or the air exhaust port of the device, or use in a condition that will disrupt the air intake/exhaust.

Doing so may cause damage to internal components and result in malfunctions.

The operating environment temperature of the device should be between 0 °C (32 °F) and 40 °C (104 °F) when using it at elevations lower than 1 400 m (4 593') above sea level, and between 0 °C (32 °F) and 35 °C (95 °F) when using it at elevations between 1 400 m (4 593') and 2 700 m (8 858') above sea level.

■ Always install the device with the bottom side down.

Failure to do so may shorten the life of the internal components and result in malfunctions.

■ When installing the device at a place, where electric statistic occurs often, take a sufficient anti-static measure before start using.

- When the device is used at a location, where static electricity occurs often, such as on a carpet, communications of the DIGITAL LINK and the wired LAN are disconnected more often.
In that case, remove static electricity and the noise source that may cause problems with an antistatic mat.
- In rare cases, the LAN connection is disabled due to static electricity or noise.
In that case, turn off the power of the device and the connected devices once and then turn on the power again.

■ Ask a qualified technician or your dealer for wiring work of the cable for DIGITAL LINK.

If the work is not properly conducted, the cable transmission characteristics do not meet, and the images and sounds may be interrupted or become unstable.

■ The device may not work properly due to strong radio wave from the broadcast station or the radio.

Install away from a facility or equipment that will generate strong radio wave. Or, sheathe the LAN cable connected to the <DIGITAL LINK OUT 1> terminal and the <DIGITAL LINK OUT 2> terminal with a metal foil or metal tubing that is grounded at both ends.

DIGITAL LINK

“DIGITAL LINK” is a technology to transmit the video, audio, Ethernet, and serial control signals using a twisted pair cable by adding unique functions by Panasonic to the HDBaseT™ communication standard formulated by HDBaseT Alliance. This device is used by connecting to the DIGITAL LINK compatible display (projector or flat panel display) or the twisted-pair-cable transmitter of other manufacturers based on the HDBaseT™ standard (receivers such as the “XTP Receiver” of Extron Electronics).

This device also supports the “long reach” communication method. “Long reach” is a communication method to extend the transmission distance to the device that is connected with the DIGITAL LINK connection. The normal transmission distance with the DIGITAL LINK connection is maximum 100 m (328'1"), but when the display connected with DIGITAL LINK connection is compatible with the “long reach” communication, the transmission distance will be maximum 150 m (492'1"). However, the image that can be transmitted is restricted to resolution of 1080/60p (dot clock 148.5 MHz) or less.

For information about the DIGITAL LINK compatible display, the twisted-pair-cable transmitters (receivers) of other manufacturers that the operation has been verified with this device, and the twisted-pair-cable transmitters (receivers) of other manufacturers that are compatible with the long-distance transmission, visit the Panasonic website ((<https://panasonic.net/cns/projector/>) or (<https://panasonic.net/cns/prodisplays/>)). Note that the confirmation of operation for devices of other manufacturers has been performed only with the items set by Panasonic Corporation, and not all the operations have been verified. For operation or performance problems caused by the devices of other manufacturers, contact the respective manufacturer.

Early Warning Software

“Early Warning Software” is the software to monitor the condition of the display (projector or flat panel display) and other peripherals in the intranet, and notify the malfunction of these devices and detect the prediction of occurrence of malfunction. Also, maintenance can be performed in advance, because this software gives notification of approximate time to replace consumables of the display, to clean each part of the display, and to replace the components of the display.

The status display of the input and output, and monitoring of the built-in fan are supported for the device.

The number of the displays registered to monitor will differ depending on the type of the license.

Maximum of 2048 displays can be registered free of charge for 90 days after the installation to the computer.

Download the software from the Panasonic website ((<https://panasonic.net/cns/projector/pass/>) or (<https://panasonic.net/cns/prodisplays/pass/>)). It is necessary to register and login to PASS*1 to download.

*1 PASS: Panasonic Professional Display and Projector Technical Support Website

For details, visit the Panasonic website ((<https://panasonic.net/cns/projector/pass/>) or (<https://panasonic.net/cns/prodisplays/pass/>)).

Disposal

To dispose of the product, ask your local authorities or dealer for correct methods of disposal.

Accessories

Make sure that the following accessories are provided with your device. Numbers enclosed in < > show the number of accessories.

AC adapter <1>

(CF-AA6373A or CF-AA6413A)

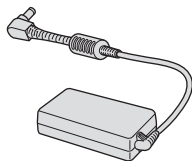

Rack mounting bracket <2>

(TKZX5287)

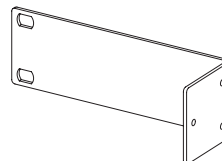

Power cord <3>

(K2CG3YY00152)

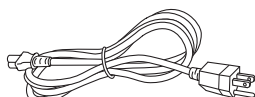

(K2CM3YY00034)

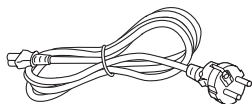

(K2CT3YY00066)

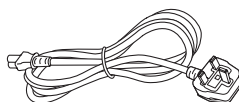

Foot <4>

(TBLX3014)



Screw (M3x6) <7>

(XSB3+6FJK)



(For attaching the AC adapter securing bracket <1>)

(For attaching the rack mounting brackets <6>)

Screw (M3x4) <4>

(XSB3+4FJ)



(For attaching the feet)

CD-ROM <1>

(TXFQB02VMB2)

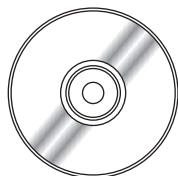

Plug for 3-pin 3.5 mm detachable terminal block <1>

(K4AA03B00024)

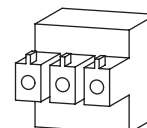

AC adapter securing bracket <1>

(TENC5824)

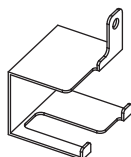

Attention

- After unpacking the device, discard the power cord cap and packaging material properly.
- Do not use the supplied AC adapter and power cord on any other equipment other than this device.
- Three types of power cords are supplied with this device. The shapes of outlets and power-supply voltage differ depending on the country or region. Use the appropriate power cord that fits into the outlet you use.
- For missing accessories, consult your dealer.
- Store small parts in an appropriate manner, and keep them away from small children.

Note

- The model numbers of accessories are subject to change without prior notice.

Contents of the supplied CD-ROM

The content of the supplied CD-ROM is as follows.

Instruction (PDF)	Operating Instructions – Functional Manual
-------------------	--

Optional accessories

Optional accessories (product name)	Model No.
D-SUB - S Video conversion cable	ET-ADSV
Early Warning Software (Basic license/3-year license)	ET-SWA100 Series*1

*1 The symbol at the end of the model number will differ depending on the type of the license.

Note

- The model number of the optional accessories is subject to change without notice.

About your device

Main body

■ Front

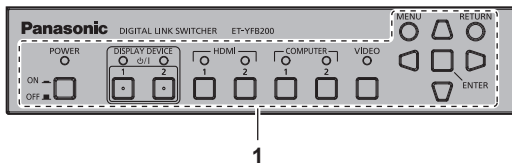

■ Side

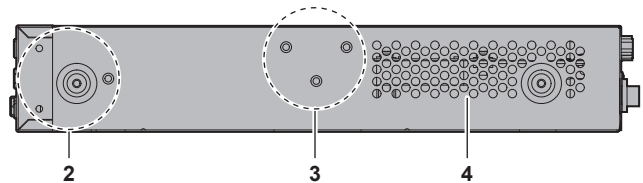

■ Rear

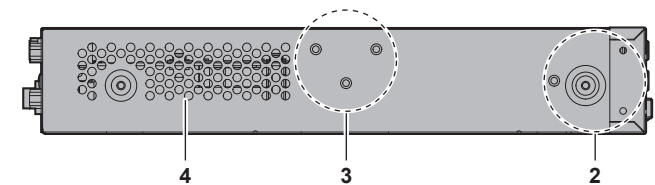
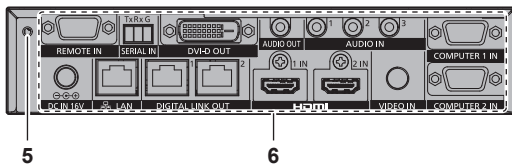

■ Bottom

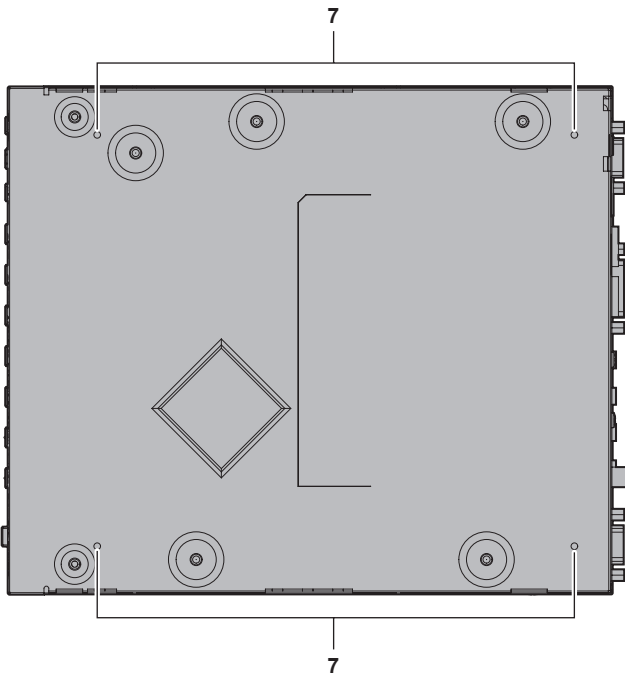

■ Top

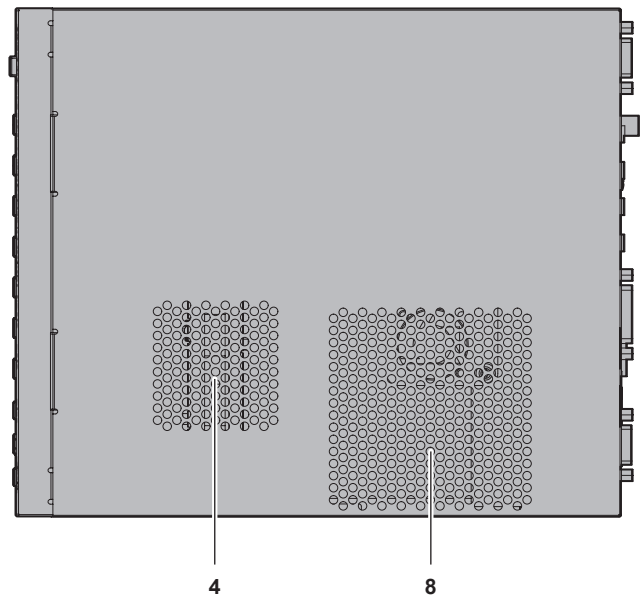



- 1 Control panel (⇒ page 17)
- 2 Rack mounting bracket mounting screw holes (⇒ page 20)
These are used when mounting the device to a rack.
- 3 (These screw holes are not used.)
- 4 Air intake ports

- 5 AC adapter securing bracket mounting screw hole (⇒ page 30)
- 6 Connecting terminals (⇒ page 18)
- 7 Feet mounting screw holes (⇒ page 20)
These are used when placing the device on a desk, etc.
- 8 Air exhaust ports

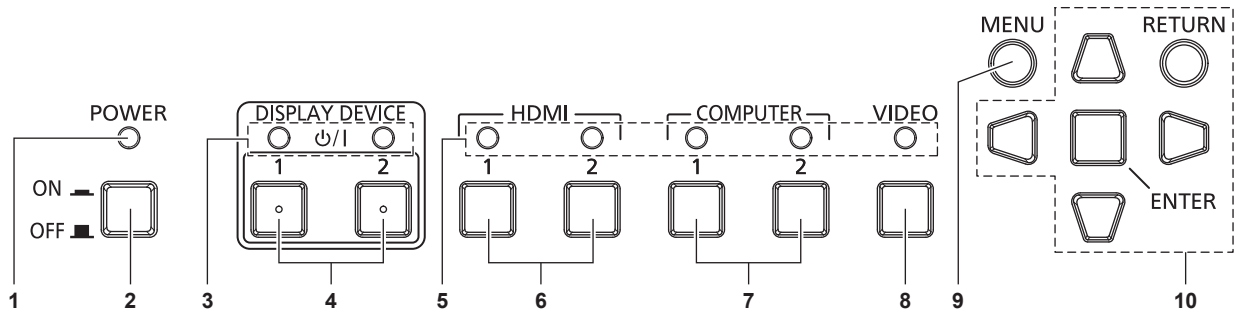
■ Control panel



- 1 Power indicator <POWER>**
Lights in green when the power of the device is on. Lights off when the power is turned off.
- 2 <POWER> button**
Turns the power off (OFF ) or turns it on (ON )
- 3 Display device indicator <DISPLAY DEVICE>**
Lights in green when the power of the display (projector or flat panel display) connected with the DIGITAL LINK is turned on. Lights off when the display is in standby mode or when a display is not connected.
- 4 <DISPLAY DEVICE ϕ/I 1> button/<DISPLAY DEVICE ϕ/I 2> button**
Switches the display (projector or flat panel display) connected with the DIGITAL LINK from standby mode to power-on condition. Or, switches from power-on condition to standby mode.
ϕ: Standby
I: Power on
- 5 Input terminal indicator**
Lights in green when it is selected.
- 6 <HDMI 1> button/<HDMI 2> button**
Switches the input to HDMI 1/HDMI 2.
- 7 <COMPUTER 1> button/<COMPUTER 2> button**
Switches the input to computer 1/computer 2.
- 8 <VIDEO> button**
Switches the input to VIDEO.
- 9 <MENU> button**
Displays the main menu.
- 10 ▲▼◀▶ buttons/<RETURN> button/<ENTER> button**
Used to operate the menu screen.

■ Connecting terminals

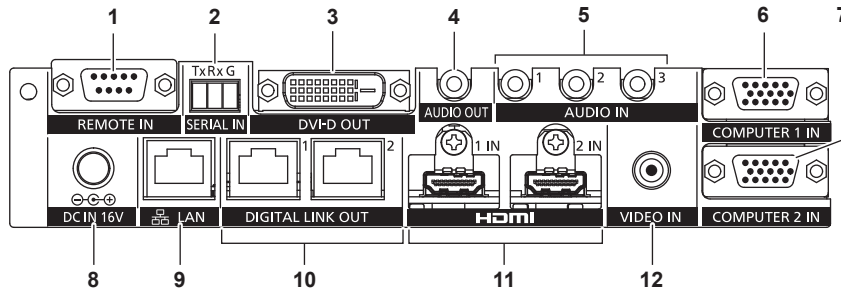

1 <REMOTE IN> terminal

This is a terminal to remotely operate the device via the external control circuit.

2 <SERIAL IN> terminal

This is a terminal to externally control the device and the display (projector or flat panel display) connected with the DIGITAL LINK. This is used by connecting to the RS-232C compatible terminal of the computer with the supplied Plug for 3-pin 3.5 mm detachable terminal block. (➔ page 83)

3 <DVI-D OUT> terminal

This is a terminal to output the video and audio signals. Only the video signal is output when a display (projector or flat panel display) or an LCD monitor is connected. Audio signal can also be output when the device is connected in cascade (multiple device connection). (➔ page 53)

4 <AUDIO OUT> terminal

This is a terminal to output the sound signal that is input to the device.

5 <AUDIO IN 1> terminal/<AUDIO IN 2> terminal/<AUDIO IN 3> terminal

This is a terminal to input the sound signals.

6 <COMPUTER 1 IN> terminal

This is a terminal to input RGB signal, Y/C signal, or YC_BC_R/YP_BP_R signal from a computer.

7 <COMPUTER 2 IN> terminal

This is a terminal to input the RGB signal from the computer or the YC_BC_R/YP_BP_R signals.

8 <DC IN> terminal

Connects the supplied AC adapter.
⊖ ⊕ ⊖: This symbol indicates the polarity of this terminal.

9 <LAN> terminal

This is a terminal to connect to the network. The display (projector or flat screen display) connected by the DIGITAL LINK can be controlled from the computer connected to this terminal.

10 <DIGITAL LINK OUT 1> terminal/<DIGITAL LINK OUT 2> terminal

Connects to the DIGITAL LINK compatible display (projector or flat panel display) or the twisted-pair-cable transmitter (receiver) of other manufacturers based on the HDBaseT™ standard.

11 <HDMI 1 IN> terminal/<HDMI 2 IN> terminal

This is a terminal to input HDMI signals.

12 <VIDEO IN> terminal

This is a terminal to input video signals.

Attention

- Wire the LAN cable, which is directly connected to this device, only indoors.

Chapter 2 **Getting Started**

This chapter describes things you need to do before using this device, such as the setup and connections.

Setting up

Mounting on a rack

This device can be mounted on the EIA standard (ANSI/EIA-310-D) compliant rack.

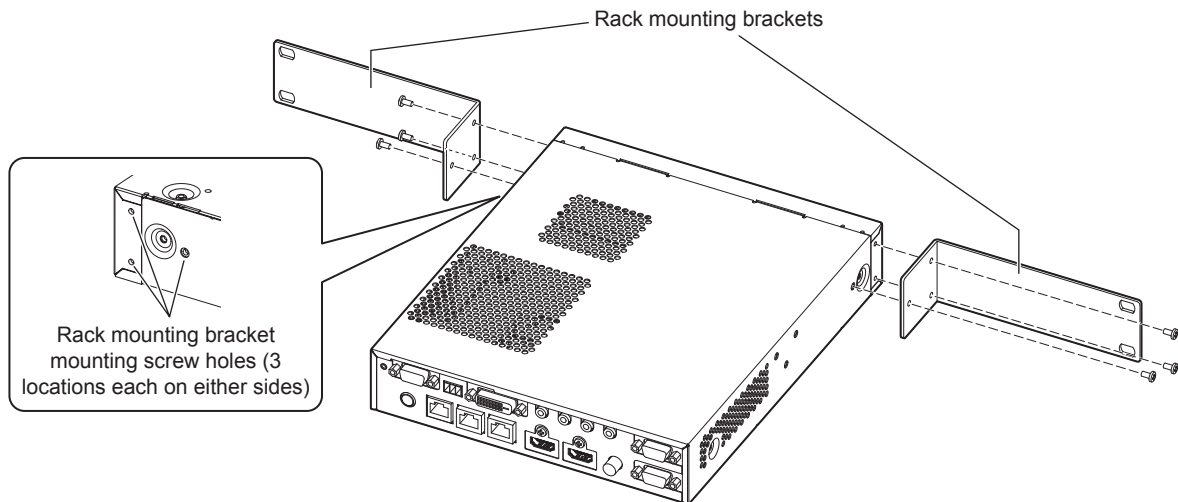

1) Attach the supplied rack mounting brackets.

- Align the supplied rack mounting brackets to either sides of the device and secure them tightly with 6 supplied screws (M3x6).

2) Mount the device to the rack.

- Mount the device in the method specified by the rack using the rack mounting screws supplied with the rack or specified by the rack.
- Securely mount to the rack using the rack mounting screws (4).

Attention

- Always turn off the power when mounting the device to the rack.
- While mounting, be careful not to slip the device.
- Be sure to fix the cables connected to the connecting terminals and the supplied AC adapter nearby such as the supports of the rack to avoid the cable and AC adapter weights directly applied to the device.
- Be sure that the temperature inside the rack on which the device is mounted does not exceed 40 °C (104 °F).
- When mounting the device to the rack, leave a gap of 1 U (44.45 mm (1-3/4")) between the device and the upper bank.
- Install the device as far as possible from the equipment with excessive heat emission (such as power amplifier) by installing in lower position, etc. If the equipment with excessive heat emission is to be installed one above the other by necessity, install with a space of 1 U (44.45 mm (1-3/4")) or more.
- Do not block the air intake port or the air exhaust port of the device, or use in a condition that will disrupt the air intake/exhaust.

Placing on a desk or a shelf

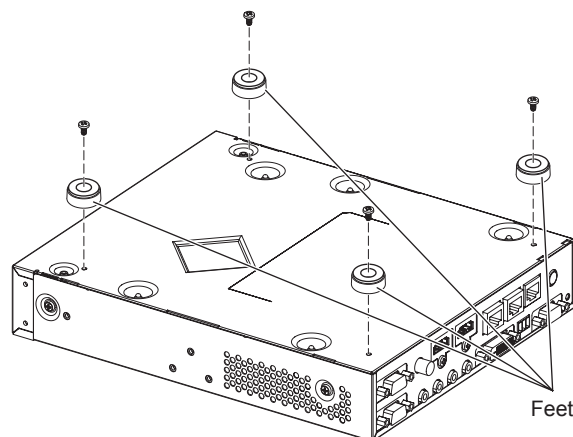

1) Mount the supplied feet to the device.

- Secure the supplied feet tightly to 4 locations on bottom of the device using the 4 supplied screws (M3x4).

Attention

- When placing the device on a desk or on a shelf, always use the feet. When buttons on the control panel are pressed, the device may slip and cause a flaw on the table or the shelf.
- Always turn off the power when attaching the feet to the device.
- When inverting the device, pay close attention not to drop or tumble.
- Place the device without applying excessive force, so the buttons, indicators, and connecting terminals do not get damaged.
- Pay attention to tips of the screws at the bottom side of the device, for not to get hurt.
- Be careful that the weights of the cables and the AC adapter connected to the connecting terminals are not applied on the device.
- Be sure that the operating environment temperature does not exceed 40 °C (104 °F) when placing the device inside a shelf.
- When using the device, leave a space of 3 cm (1-3/16") or more on both sides of the device, and a space of 4.5 cm (1-25/32") or more on top of the device.
- When using the device, do not block the air exhaust port by placing objects on top of the device.

Connecting

Before connecting

- Before connecting, carefully read the Operating Instructions of the equipment to be connected.
- Turn off the power of all devices before connecting cables.
- Take note of the following points before connecting the cables. Failure to do so may result in malfunctions.
 - When connecting the cable to this device or to the equipment to be connected with this device, touch a metal object around you to discharge the static from your body before holding the cable.
 - Do not use unnecessarily long cable when connecting this device and the display (projector or flat panel display). Longer the cable is, easier to be influenced by a noise. If the cable is used in a winding condition, it becomes an antenna, which more easily gets influenced by a noise.
 - When connecting cables, connect GND first, then insert the connecting terminal of the connecting equipment in a straight manner.
- If connecting cables necessary for the system connection are not supplied with the connecting equipment as accessories or not available as an option, prepare cables that are compatible with the connecting equipment.
- If video signals from video equipment contain too much jitter, the images on the screen may wobble. In this case, a time base corrector (TBC) must be connected.
- Signals that can be connected to this device are video signal, Y/C signal, YC_BC_R/YP_BP_R signal, analog RGB signal (synchronization signal is TTL level), and HDMI signal.
- Some computer models are not compatible with this device.
- For details of the video signal supported by this device, refer to “Compatible signals” (► page 88).

<COMPUTER 1 IN> terminal pin assignments and signal names

Outside view	Pin No.	Signal name	Pin No.	Signal name
	(1)	R/P _R /C	(9)	—
	(2)	G/Y/Y	(10)	GND
	(3)	B/P _B	(11)	GND
	(4)	—	(12)	DDC data
	(5)	GND	(13)	HD/SYNC
	(6)	GND	(14)	VD
	(7)	GND	(15)	DDC clock
	(8)	GND		

<COMPUTER 2 IN> terminal pin assignments and signal names

Outside view	Pin No.	Signal name	Pin No.	Signal name
	(1)	R/P _R	(9)	—
	(2)	G/Y	(10)	GND
	(3)	B/P _B	(11)	GND
	(4)	—	(12)	DDC data
	(5)	GND	(13)	HD/SYNC
	(6)	GND	(14)	VD
	(7)	GND	(15)	DDC clock
	(8)	GND		

<HDMI 1 IN> terminal/<HDMI 2 IN> terminal pin assignment and signal name

Outside view	Pin No.	Signal name	Pin No.	Signal name
Odd-numbered pins of (1) to (19) 	(1)	T.M.D.S data 2+	(11)	T.M.D.S clock shield
	(2)	T.M.D.S data 2 shield	(12)	T.M.D.S clock-
	(3)	T.M.D.S data 2-	(13)	CEC
	(4)	T.M.D.S data 1+	(14)	—
	(5)	T.M.D.S data 1 shield	(15)	SCL
	(6)	T.M.D.S data 1-	(16)	SDA
	(7)	T.M.D.S data 0+	(17)	DDC/CEC GND
	(8)	T.M.D.S data 0 shield	(18)	+5 V
	(9)	T.M.D.S data 0-	(19)	Hot plug detection
	(10)	T.M.D.S clock+		
Even-numbered pins of (2) to (18)				

<DVI-D OUT> terminal pin assignments and signal names

Outside view	Pin No.	Signal name	Pin No.	Signal name
	(1)	T.M.D.S data 2-	(13)	—
	(2)	T.M.D.S data 2+	(14)	+5 V
	(3)	T.M.D.S data 2/4 shield	(15)	GND
	(4)	—	(16)	Hot plug detection
	(5)	—	(17)	T.M.D.S data 0-
	(6)	DDC clock	(18)	T.M.D.S data 0+
	(7)	DDC data	(19)	T.M.D.S data 0/5 shield
	(8)	—	(20)	—
	(9)	T.M.D.S data 1-	(21)	—
	(10)	T.M.D.S clock 1+	(22)	T.M.D.S clock shield
	(11)	T.M.D.S data 1/3 shield	(23)	T.M.D.S clock+
	(12)	—	(24)	T.M.D.S clock-

Connecting example: Image input device and audio device

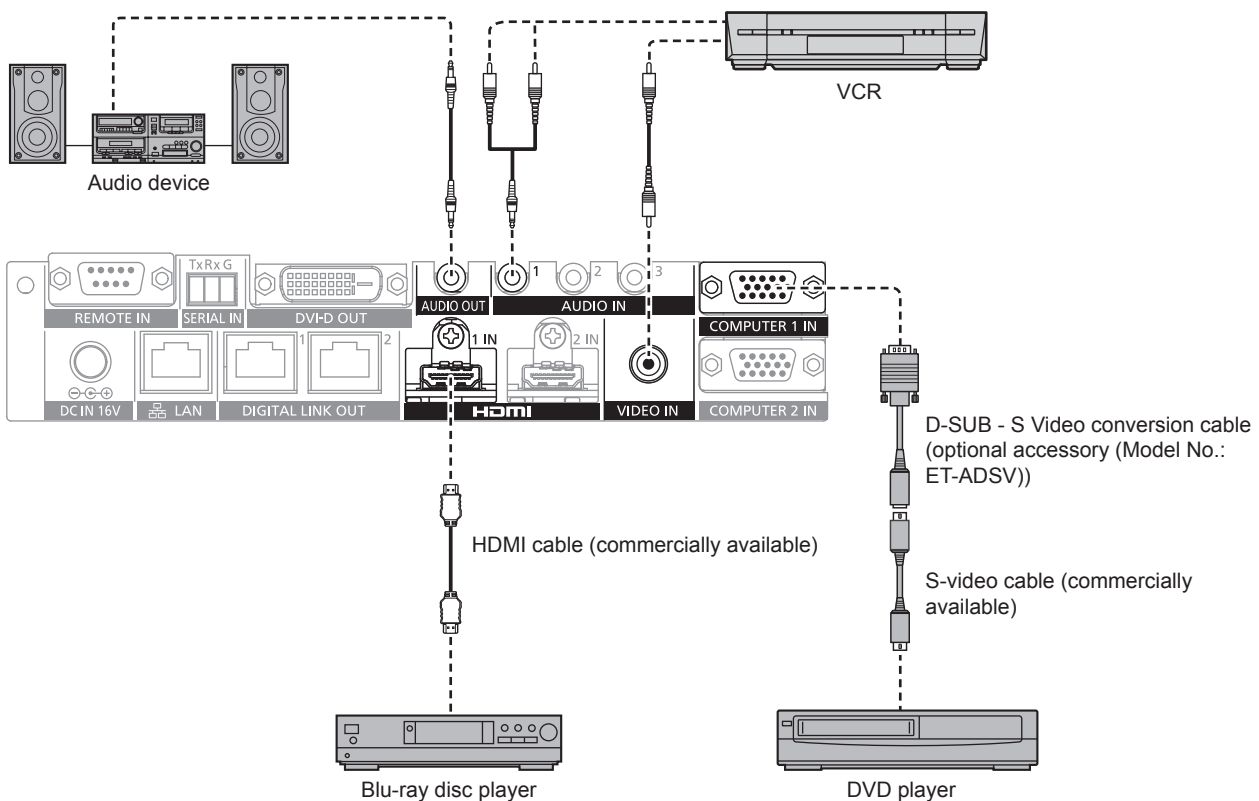

Note

- For an HDMI cable, use an HDMI High Speed cable that conforms to HDMI standards. If a cable that does not conform to HDMI standards is used, images may be interrupted or may not be displayed.
- The <HDMI 1 IN> terminal/<HDMI 2 IN> terminal of this device can be connected to the equipment with the DVI-D terminal by using the HDMI/DVI conversion cable. However, this may not properly function as no image is output on some equipment.
- To input the Y/C signal to the <COMPUTER 1 IN> terminal using the optional D-SUB - S Video conversion cable (Model No.: ET-ADSV), go to the [OPTION] menu → [COMPUTER IN] and set [COMPUTER 1 INPUT SETTING] to [Y/C]. (➔ page 48)
The <COMPUTER 2 IN> terminal does not support input of Y/C signal.
- To automatically adjust the resolution of the image input device connected to the <HDMI 2 IN> terminal to the resolution of the display (projector or flat panel display) connected to the <DIGITAL LINK OUT 1> terminal or the <DIGITAL LINK OUT 2> terminal, go to the [OPTION] menu → [HDMI IN] and set [HDMI 2 EDID MODE] to [COPY]. (➔ page 50)
- It may not operate properly, such as audio does not output, if the setting in the [OPTION] menu → [AUDIO SETTING] → [AUDIO IN SELECT] is incorrect.
- This device does not support VIERA Link (HDMI).

Connecting example: Computers

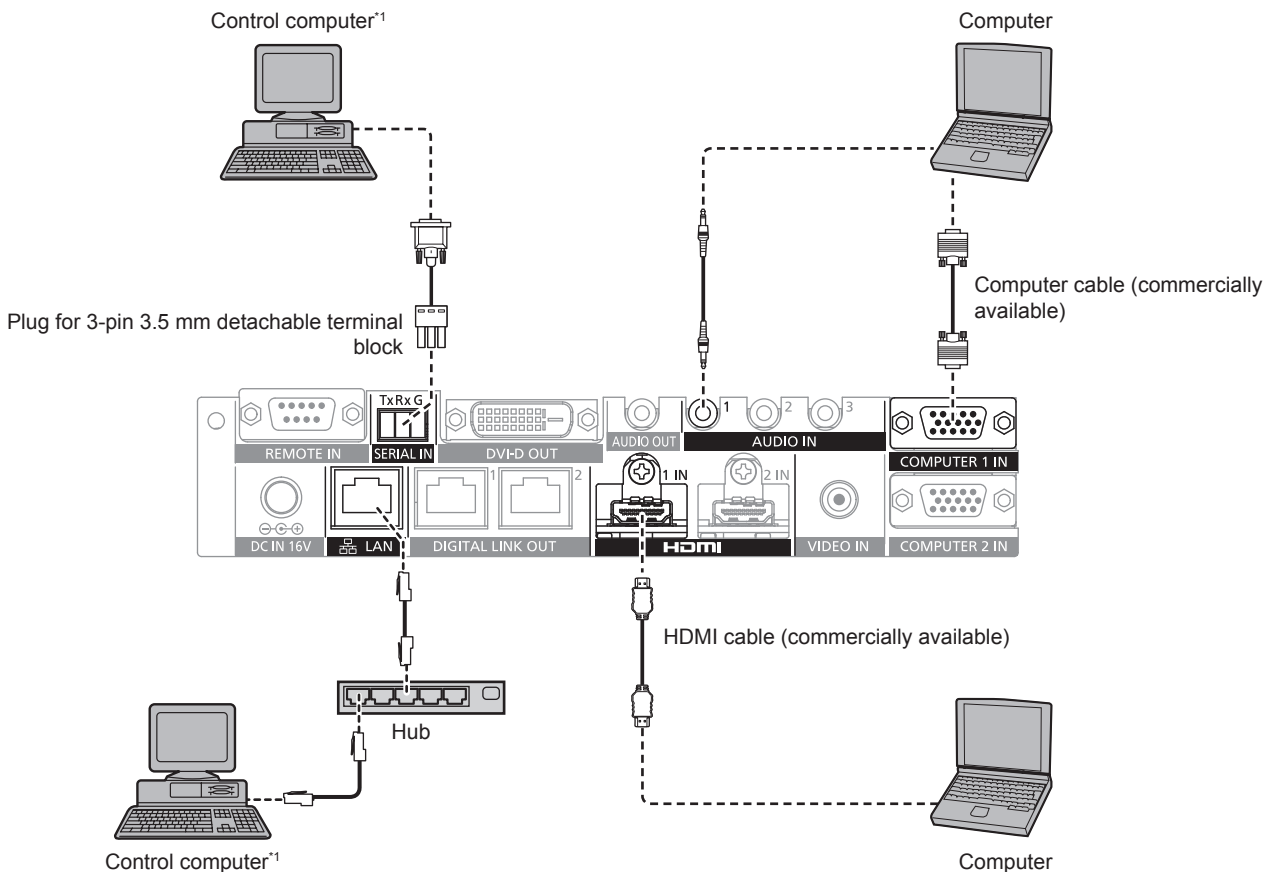

*1 Controls this device and the display (projector or flat panel display) main body.

Attention

- When connecting this device to a computer or an external device, use the power cord supplied with each device and commercially available shielded cables.
- Since the <LAN> terminal is very close to the <REMOTE IN> terminal or the <SERIAL IN> terminal, it may be difficult to remove the cable connected to the <LAN> terminal when a cable is connected to the <REMOTE IN> terminal or the <SERIAL IN> terminal. When removing the cable connected to the <LAN> terminal, remove the cable connected to the <REMOTE IN> terminal or the <SERIAL IN> terminal in advance.

Note

- To connect to the <SERIAL IN> terminal, refer to “<SERIAL IN> terminal” (➔ page 83).

Connecting example: Image display device

When connecting to the DIGITAL LINK compatible display

The DIGITAL LINK compatible display (projector or flat panel display) can be connected to the <DIGITAL LINK OUT 1> terminal and the <DIGITAL LINK OUT 2> terminal of this device. Two displays regardless of the model can be connected to the <DIGITAL LINK OUT 1> terminal and the <DIGITAL LINK OUT 2> terminal simultaneously, but the display connected to the <DIGITAL LINK OUT 1> terminal will take priority.

- Operation of this device by the remote control of the display
For details, refer to “Operating with the remote control” (➔ page 35).
- Displaying the on-screen menu (main menu) of this device by the menu operation on the display main body
For details, refer to “Operating with the remote control” (➔ page 35).
- Display that becomes a copy source of the EDID (extended display identification data)
For details, refer to “Setting [COMPUTER 2 EDID MODE]” (➔ page 49) and [HDMI IN] (➔ page 50).
- Display to become target to automatically match the output resolution
For details, refer to [DIGITAL LINK OUT] (➔ page 52).

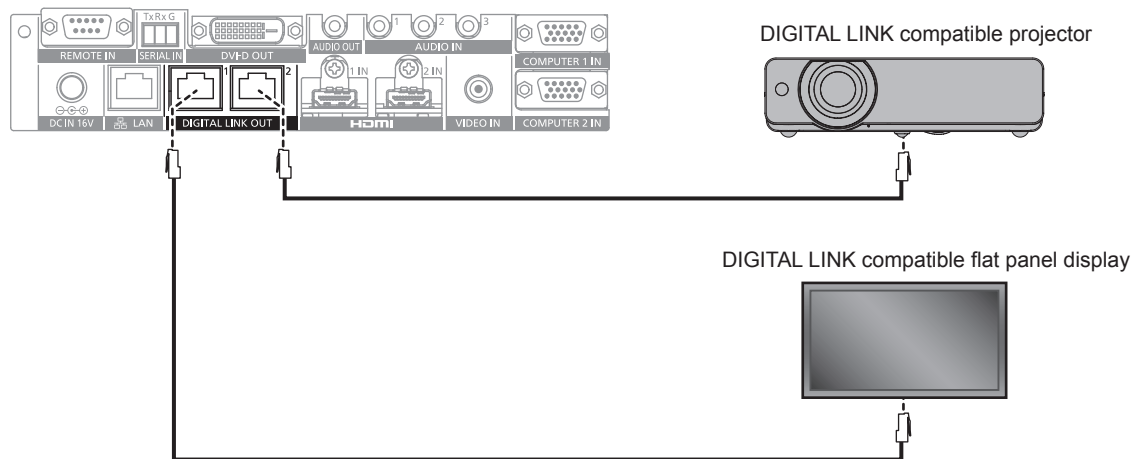

Attention

- Do not use a hub to connect this device with the DIGITAL LINK compatible display (projector or flat panel display).
- Ask a qualified technician or your dealer for wiring work of the cable for DIGITAL LINK. The image or audio may be interrupted or disrupted by not achieving the cable transmission characteristics due to defective work.
- Use the cable conforming to following conditions as the LAN cable between this device and the DIGITAL LINK compatible display (projector or flat panel display).
 - Compatible to the CAT5e or a higher standard
 - Shield type (including the connector)
 - Straight wire connection
 - Single wire
- Confirm that the cable specification satisfies the characteristics of CAT5e or higher by using a cable tester or a cable analyzer when laying the cable.
- When a relay connector is used in the middle, measure in a condition that the relay connector is included.
- To reduce the effect of a noise, install and use the cable between this device and the DIGITAL LINK compatible display (projector or flat panel display) unwound and stretched out.
- Do not pull the cable with a strong force. Moreover, do not bend or fold forcibly.
- Do not bind with other cables, especially the power cable, and keep as much distance from other parallelly set cables.
- When connecting with the DIGITAL LINK compatible display (projector or flat panel display), open the DIGITAL LINK status menu of these displays after the cable is laid out, and confirm that the signal quality is -12 dB or less.
- Since the <DVI-D OUT> terminal is very close to the <DIGITAL LINK OUT 1> terminal/<DIGITAL LINK OUT 2> terminal, removing of the cable connected to the <DIGITAL LINK OUT 1> terminal/<DIGITAL LINK OUT 2> terminal may be difficult when cable is connected to the <DVI-D OUT> terminal. When removing the cable connected to the <DIGITAL LINK OUT 1> terminal/<DIGITAL LINK OUT 2>, remove the cable connected to the <DVI-D OUT> terminal.

Note

- Maximum transferable distance is normally 100 m (328'1"). If the display (projector or flat panel display) to be connected is supporting the long reach communication method, it can transfer up to 150 m (492'1"). If the distance exceeds this, image or audio may be interrupted or error may occur in the LAN communication. Note that the usage exceeding the maximum transferable distance is not covered by the Panasonic support. Depending on the display to be connected, there may be limit in the signal or the distance that the display can receive. For details, refer to the Operating Instructions of the display in use.

When performing cascade connection for this device

By connecting the devices with cascade connection (multiple device connection) using the HDMI/DVI conversion cable, video signal can be output to 3 or more DIGITAL LINK compatible displays (projector or flat panel display).

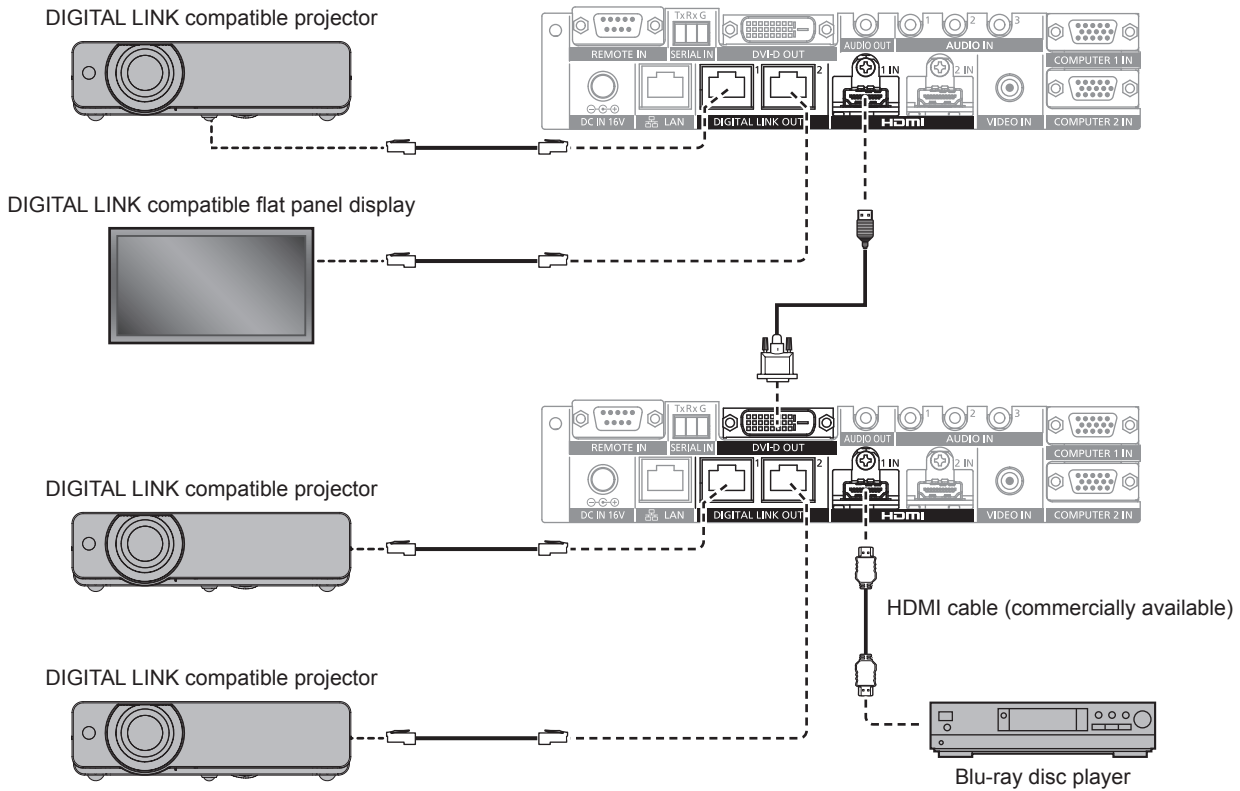

Note

- Audio signal can also be output from the <DVI-D OUT> terminal when the device is connected in cascade. Set the [OPTION] menu → [DVI-D OUT] to [CASCADE]. (→ page 53)
- Only the video and audio signals can be received on the display connected to the <DIGITAL LINK OUT 1> terminal/<DIGITAL LINK OUT 2> terminal of the device that is connected in cascade. Ethernet and serial control signals can only be sent/received via the display connected to the original cascade connection (first layer).
- When playing back the same image or the image with audio on multiple displays simultaneously by connecting this device in cascade, the misalignment of the displayed image or the played back audio may be obvious depending on the viewing or listening position. Misalignment of the audio can be avoided by using the audio output of one of the connected displays, or output the audio using the <AUDIO OUT> terminal of one of the device.
General guideline of the misalignment of the image and audio per 1 frame of image when 1 device is added while using 2 or more devices connected is as follows.

	Image	Audio
Analog signal	0.5 frames	0.07 frames
Digital signal	0.5 frames	1.2 frames

When connecting to non-DIGITAL LINK compatible display

The non-DIGITAL LINK compatible image display device and this device can be connected in following method.

- Directly connect to the <DVI-D OUT> terminal of the device.
- Connect to the <DIGITAL LINK OUT 1> terminal or the <DIGITAL LINK OUT 2> terminal of the device via twisted-pair-cable transmitter (receiver) of other manufacturers.

Connecting to the <DVI-D OUT> terminal

Even if it is a non-DIGITAL LINK compatible display (projector or flat panel display) or other image display device such as LCD monitor, image can be displayed by connecting to the <DVI-D OUT> terminal of the device if it is an image display device supporting the HDMI connection or the DVI-D connection.

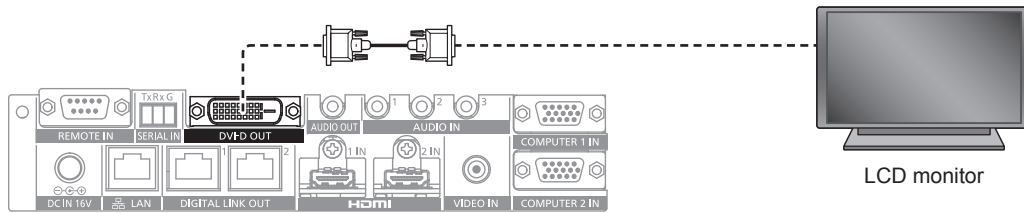

Note

- The <DVI-D OUT> terminal can connect to the HDMI and DVI-D compliant devices. However, this may not properly display as no image is output on some devices.

Using a twisted-pair-cable transmitter of other manufacturers

When connecting with a Panasonic non-DIGITAL LINK compatible display (projector or flat panel display), use a twisted-pair-cable transmitter (receiver) of other manufacturers based on the HDBaseT™ standard.

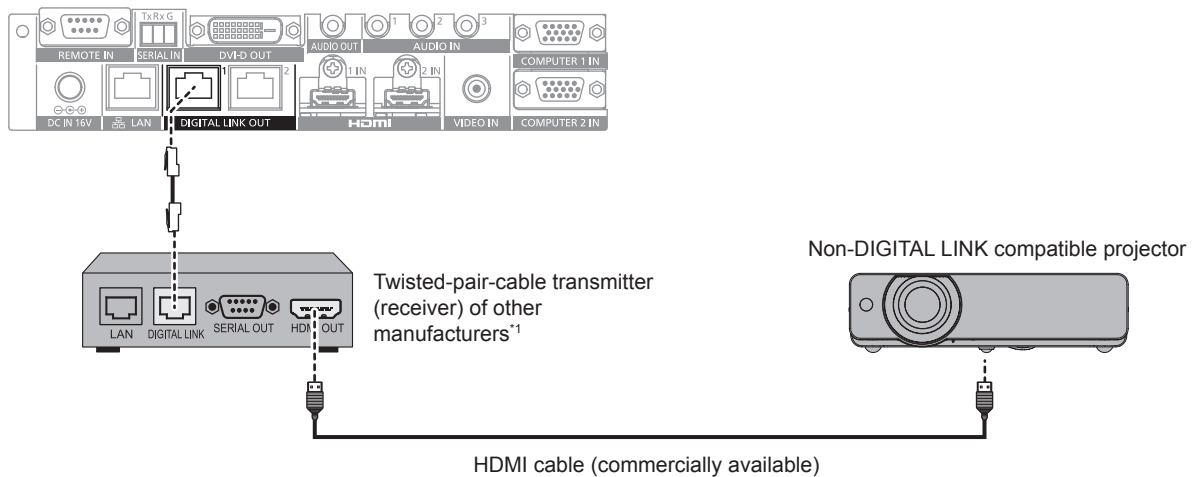

*1 Name of the DIGITAL LINK terminal may differ depending on the manufacturer.

Attention

- When connecting a display (projector or flat panel display) using a twisted-pair-cable transmitter (receiver) of other manufacturers based on HDBaseT™ standard, do not use another twisted-pair-cable transmitter (receiver) between the original twisted-pair-cable transmitter of other manufacturers and the display. The image or the audio may be interrupted or disrupted.
- Do not use a hub between this device and the twisted-pair-cable transmitter (receiver).
- Ask a qualified technician or your dealer for wiring work of the cable for DIGITAL LINK. If the work is not properly conducted, the cable transmission characteristics do not meet, and the images and sounds may be interrupted or become unstable.
- Use the cable conforming to following conditions as the LAN cable between this device and the twisted-pair-cable transmitter (receiver).
 - Compatible with CAT5e or higher
 - Shielded type (including connectors)
 - Straight-through
 - Single wire
- Confirm that the cable specification satisfies the characteristics of CAT5e or higher by using a cable tester or a cable analyzer when laying the cable.
 - When a relay connector is used, include it in the measurement.
- To reduce the effect of a noise, install and use the cable between this device and the twisted-pair-cable transmitter (receiver) unwound and stretched out.
- Do not pull cables forcefully. In addition, do not bend or fold cables unnecessarily.
- Do not bind with other cables, especially the power cable, and keep as much distance from other parallelly set cables.
- Since the <DVI-D OUT> terminal is very close to the <DIGITAL LINK OUT 1> terminal/<DIGITAL LINK OUT 2> terminal, removing of the cable connected to the <DIGITAL LINK OUT 1> terminal/<DIGITAL LINK OUT 2> terminal may be difficult when cable is connected to the <DVI-D OUT> terminal. When removing the cable connected to the <DIGITAL LINK OUT 1> terminal/<DIGITAL LINK OUT 2>, remove the cable connected to the <DVI-D OUT> terminal.

Note

- Maximum transferable distance is normally 100 m (328'1"). If the twisted-pair-cable transmitter (receiver) to be connected is supporting the long reach communication method, it can transfer up to 150 m (492'1"). If the distance exceeds this, image or audio may be interrupted or error may occur in the LAN communication. Note that the usage exceeding the maximum transferable distance is not covered by the Panasonic support. Depending on the twisted-pair-cable transmitter (receiver) to be connected, there may be limit in the signal or the distance that can be received. For details, refer to the Operating Instructions of the twisted-pair-cable transmitter (receiver) in use.
- Following functions cannot be used when the device is connected to non-DIGITAL LINK compatible display (projector or flat panel display) via the twisted-pair-cable transmitter (receiver) based on the HDBaseT™ standard.
 - Operation of this device by the remote control of the display
 - No signal sleep function
- For information about the twisted-pair-cable transmitters (receivers) of other manufacturers that the operation has been verified with this device, visit the Panasonic website (<https://panasonic.net/cns/projector/>) or (<https://panasonic.net/cns/prodisplays/>). Note that the confirmation of operation for devices of other manufacturers has been performed only with the items set by Panasonic Corporation, and not all the operations have been verified. For operation or performance problems caused by the devices of other manufacturers, contact the respective manufacturer.

Chapter 3 Basic Operations

This chapter describes basic operations to start with.

Turning on/off the device

Connecting the AC adapter

Confirm that the <POWER> button of the device is in the <OFF> condition before connecting the AC adapter and the power cord.

For detailed handling of the AC adapter and the power cord, refer to “Read this first!” (➔ page 4).

Attaching procedure

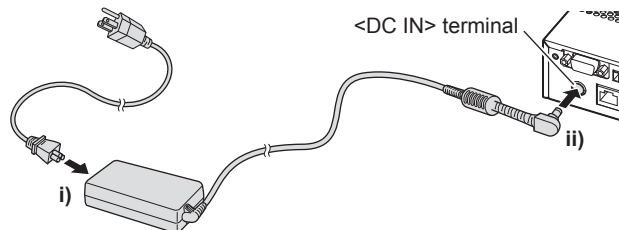

Fig. 1

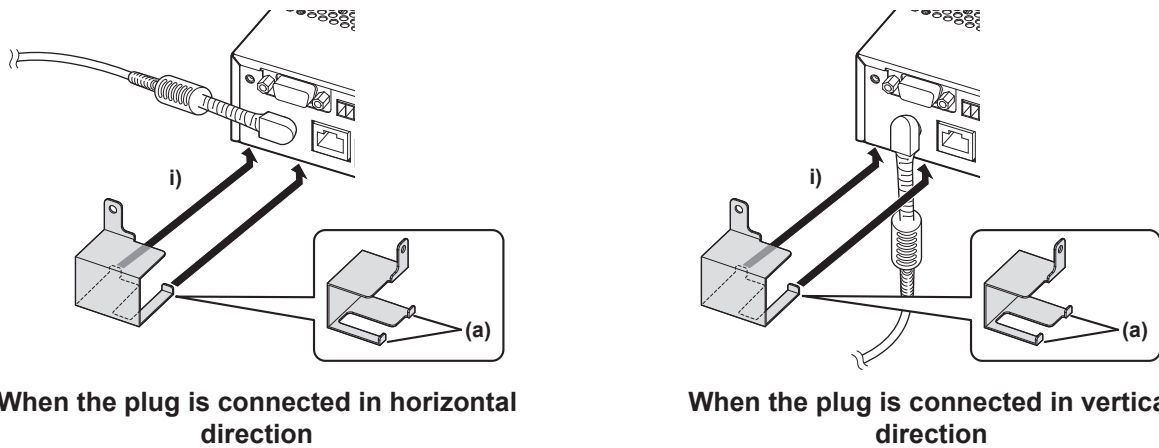

Fig. 2

When the plug is connected in horizontal direction

When the plug is connected in vertical direction

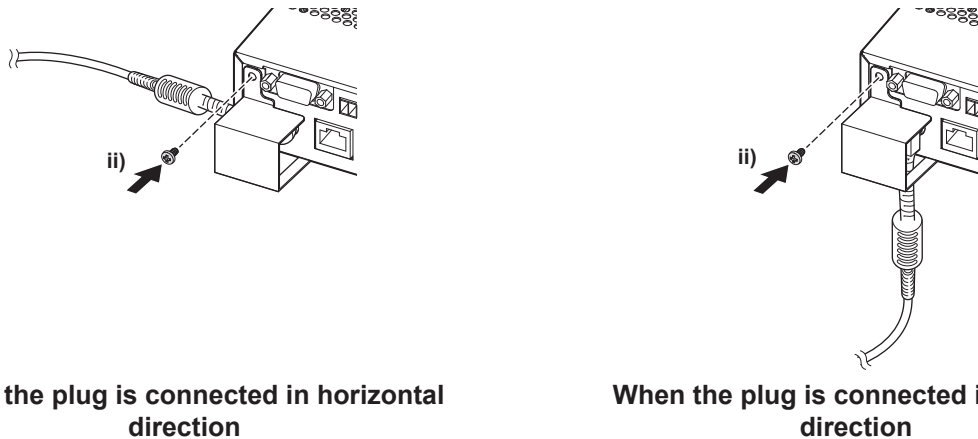

Fig. 3

When the plug is connected in horizontal direction

When the plug is connected in vertical direction

- 1) Securely insert the connector of the power cord into the AC adapter, and then securely insert the plug of the AC adapter into the <DC IN> terminal at the connecting terminal section. (Fig. 1)
- 2) Attach the supplied AC adapter securing bracket to the device.
 - i) Hook the tabs (a) of the AC adapter securing bracket to the holes on the bottom of the device (2 locations). (Fig. 2)
 - Turn the plug of the AC adapter vertically or horizontally in accordance to the installation condition.
 - ii) Attach the bracket so that the plug of the AC adapter is covered, and secure with 1 supplied screw (M3x6). (Fig. 3)
 - Securely tighten the screw.

Attention

- Do not attach the power cord and the AC adapter with the front side of the device down.
- Be sure to fix the cables connected to the device and the supplied AC adapter nearby such as the legs of the desk to avoid the cable and AC adapter weights directly applied to the device.

Removing procedure

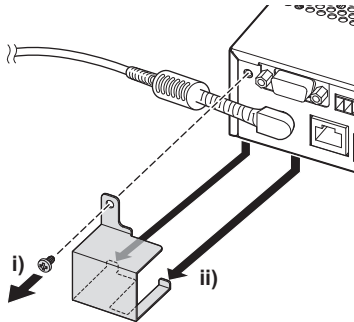

Fig. 1

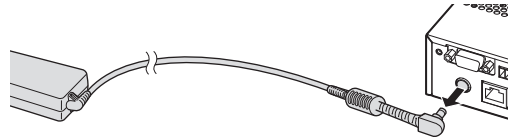
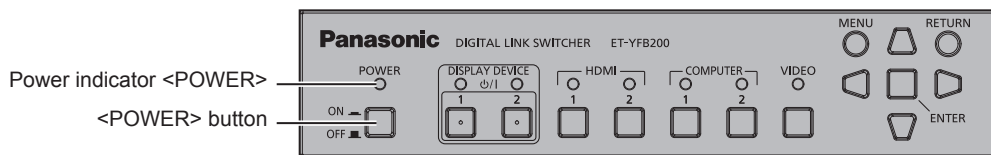

Fig. 2

- 1) Confirm that the <POWER> button of the device is in the <OFF> condition, and then disconnect from the outlet holding on the power plug.
- 2) Remove the AC adapter securing bracket. (Fig. 1)
 - i) Remove the screw securing the AC adapter securing bracket.
 - ii) Remove the AC adapter securing bracket.
- 3) Hold the plug of the AC adapter and disconnect from the <DC IN> terminal. (Fig. 2)

Turning on the power of the DIGITAL LINK Switcher

Confirm the connection of the external device before turning on the power.



- 1) Connect the power plug to an outlet.
- 2) Press the <POWER> button to turn on the power.
 - The power indicator <POWER> will light up.

Note

- When an audio system is used by connecting to the <AUDIO OUT> terminal, a noise may sound from the external audio system when the power of the device is turned off/on. In this case, turn off/on the device with the sound system turned off.
- If the power indicator <POWER> or the input terminal indicator is blinking, consult your dealer.

Turning off the power of the DIGITAL LINK Switcher

- 1) Press the <POWER> button to turn off the power.
 - The power indicator <POWER> will turn off.

Note

- When an audio system is used by connecting to the <AUDIO OUT> terminal, a noise may sound from the external audio system when the power of the device is turned off/on. In this case, turn off/on the device with the sound system turned off.

Turning on/off the power of the display

The power of the display (projector or flat panel display) connected to the <DIGITAL LINK OUT 1> terminal or the <DIGITAL LINK OUT 2> terminal of the device can be turned off/on with the <DISPLAY DEVICE ϕ /| 1> button or the <DISPLAY DEVICE ϕ /| 2> button in the control panel of the device.

- The display (projector or flat panel display) connected to the <DIGITAL LINK OUT 1> terminal can be operated with the <DISPLAY DEVICE ϕ /| 1> button. Also, the display connected to the <DIGITAL LINK OUT 2> terminal can be operated with the <DISPLAY DEVICE ϕ /| 2> button.

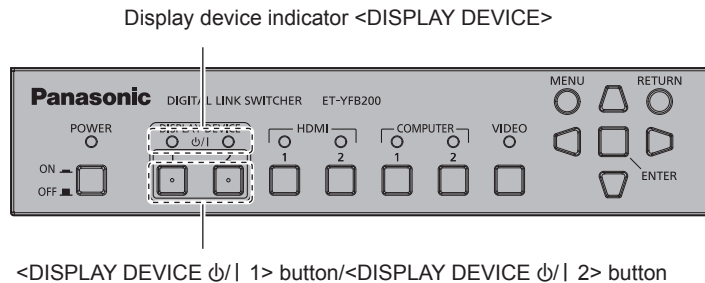

Before turning off/on the power of the display

Checking the status of the device

Turn on the power of the device before operating the <DISPLAY DEVICE ϕ /| 1> button/<DISPLAY DEVICE ϕ /| 2> button. (➡ page 31)

To turn off/on the power of the display, set [(IN)PARITY] of the [OPTION] menu → [RS-232C] (➡ page 58) to following.

- To turn off/on the power of the projector
 - Set in accordance to the parity condition of the serial input terminal of the projector.
- To turn off/on the power of the flat panel display
 - Set to [NONE].
- To turn off/on the power of both the projector and the flat panel display
 - Set to [NONE].
 - Also set the parity condition of the serial input terminal of the projector to “NONE”.

Checking the display status

The target display is required to be in following conditions to turn off/on the power of the display with the <DISPLAY DEVICE ϕ /| 1> button/<DISPLAY DEVICE ϕ /| 2> button. For details, refer to the Operating Instructions of the display in use.

■ To turn on the power of the display

- To turn on the power of the projector
 - Projector is in standby mode.
 - Network function is enabled even when the projector is in standby mode.
 - Communication method of DIGITAL LINK is enabled.
 - Control for the response is enabled when the “ID ALL” command is received.
- To turn on the power of the flat panel display
 - Flat panel display is in standby mode.
 - Control with the DIGITAL LINK terminal or the LAN terminal is enabled.
 - RS-232C communication via the twisted-pair-cable transmitter is enabled.
 - Control for the response is enabled when the “ID ALL” command is received.

■ To turn off the power of the display

- To turn off the power of the projector
 - Power of the projector is turned on (projecting mode).
 - Communication method of DIGITAL LINK is enabled.
 - Control for the response is enabled when the “ID ALL” command is received.
- To turn off the power of the flat panel display

- Power of the flat panel display is turned on.
- Control with the DIGITAL LINK terminal or the LAN terminal is enabled.
- RS-232C communication via the twisted-pair-cable transmitter is enabled.
- Control for the response is enabled when the "ID ALL" command is received.

Turning on the power of the display

This is the operation to switch the power of the display (projector or flat panel display) from standby mode to power-on condition.

- 1) **Press and hold the <DISPLAY DEVICE ϕ /| 1> button or the <DISPLAY DEVICE ϕ /| 2> button for 3 seconds or longer, and then release the button.**
 - The power of the display connected to the <DIGITAL LINK OUT 1> terminal or the <DIGITAL LINK OUT 2> terminal is turned on. The display device indicator <DISPLAY DEVICE> of the corresponding side will light up after a while.

Note

- It may take up to 30 seconds until the display device indicator <DISPLAY DEVICE> turns on when the power is turned on at the display main body.
- Press and hold the <DISPLAY DEVICE ϕ /| 1> button or the <DISPLAY DEVICE ϕ /| 2> button for 3 seconds or longer, and release the button after the display device indicator <DISPLAY DEVICE> is blinking. This button operation will be invalid when the time holding the button is less than 3 seconds.
- Depending on the status of the connected display, the power of the display cannot be turned off/on with the operation from this device.

Turning off the power of the display

This is the operation to switch the power of the display (projector or flat panel display) from power-on condition to standby mode.

- 1) **Press and hold the <DISPLAY DEVICE ϕ /| 1> button or the <DISPLAY DEVICE ϕ /| 2> button for 3 seconds or longer, and then release the button.**
 - The power of the display connected to the <DIGITAL LINK OUT 1> terminal or the <DIGITAL LINK OUT 2> terminal is turned off and go into standby mode. The display device indicator <DISPLAY DEVICE> of the corresponding side will turn off.

Note

- Press and hold the <DISPLAY DEVICE ϕ /| 1> button or the <DISPLAY DEVICE ϕ /| 2> button for 3 seconds or longer, and release the button after the display device indicator <DISPLAY DEVICE> is blinking. This button operation will be invalid when the time holding the button is less than 3 seconds.
- The power of the display connected to the <DIGITAL LINK OUT 1> terminal or the <DIGITAL LINK OUT 2> terminal is not turned off in conjunction even when the power of this device is turned off. Turn off the power of the display before turning off the power of this device.
- Depending on the status of the connected display, the power of the display cannot be turned off/on with the operation from this device.

Operating with the remote control

This device can be operated with the remote control of the display when the display (projector or flat panel display) is connected to the <DIGITAL LINK OUT 1> terminal/<DIGITAL LINK OUT 2> terminal. Depending on the remote control, it may not have some buttons or operations may be different.

- The operation may not be possible when the remote control signal receiver of the connected display is under strong light, such as fluorescent lamp. Use it in a place distant from the light source.
- When DIGITAL LINK compatible displays are connected to both <DIGITAL LINK OUT 1> terminal and <DIGITAL LINK OUT 2> terminal of the device, operation of the device is possible only with the remote control of the display connected to the <DIGITAL LINK OUT 1> terminal.

Switching the input

Switch the input with the [INPUT SELECT] menu of this device.

ET-YFB200	DIGITAL LINK SWITCHER	
 INPUT SELECT	• HDMI 1	
	HDMI 2	
	COMPUTER 1	
	COMPUTER 2	
	VIDEO	

Switching the input when projector is used

- 1) **Press the DIGITAL LINK button on the remote control.**
 - Input of the projector will switch to DIGITAL LINK, and the [INPUT SELECT] menu of this device is displayed.
- 2) **Press ▲▼ on the remote control to select the input, and press the ENTER button.**
 - This operation can be also performed by using the DIGITAL LINK button on the remote control. The input is switched every time the button is pressed.





Switching the input when flat panel display is used

It is necessary to assign the input switch to the number button with the function setting of the flat panel display when the remote control of the flat panel display is used for the operation.

- 1) **Press the number button of the remote control where the DIGITAL LINK is assigned.**
 - Input of the flat panel display will switch to DIGITAL LINK, and the [INPUT SELECT] menu of this device is displayed.
- 2) **Press ▲▼ on the remote control to select the input, and press the ENTER button.**

Displaying the on-screen menu (main menu)

Display the on-screen menu (main menu).

ET-YFB200	DIGITAL LINK SWITCHER	
 INPUT SELECT	• HDMI 1	
 PICTURE	HDMI 2	
 POSITION	COMPUTER 1	
 LANGUAGE	COMPUTER 2	
 OPTION	VIDEO	

How to display the on-screen menu (main menu) when the projector is used

- 1) **Press the DIGITAL LINK button on the remote control.**
 - The [INPUT SELECT] menu of this device is displayed.
- 2) **Press the MENU button or the RETURN button on the remote control.**
 - On-screen menu (main menu) is displayed.

How to display the on-screen menu (main menu) when the flat panel display is used

It is necessary to assign the input switch to the number button with the function setting of the flat panel display main unit when the remote control of the flat panel display is used for the operation.

- 1) **Press the number button of the remote control where the DIGITAL LINK is assigned.**
 - The [INPUT SELECT] menu of this device is displayed.
- 2) **Press the RETURN button on the remote control.**
 - On-screen menu (main menu) is displayed.

Note

- The on-screen menu (main menu) of this device can be displayed by the menu operation of the display (projector or flat panel display) connected to the <DIGITAL LINK OUT 1> terminal/<DIGITAL LINK OUT 2> terminal of this device. The operation will differ depending on the model of the display, so refer to the Operating Instruction of the display in use. When displays are connected to both <DIGITAL LINK OUT 1> terminal and the <DIGITAL LINK OUT 2> terminal, displaying of the on-screen menu (main menu) of this device is possible only with the menu operation of the display connected to the <DIGITAL LINK OUT 1> terminal. For the operation procedure, refer to the Operating Instructions of the display in use.
- Depending on the model of the display (projector or flat panel display) in use, the MENU button or the RETURN button may not be present on the remote control.
- For detailed operating method of the on-screen menu (main menu) of this device, refer to “Menu navigation” (➔ page 38).

Chapter 4 Settings

This chapter describes the settings and adjustments you can make using the on-screen menu.

Menu navigation

The on-screen menu (menu screen) is used to perform various settings and adjustments of this device.

Navigating through the menu

Operating procedure

MENU



1) Press the <MENU> button on the control panel.

- The main menu screen is displayed.

ET-YFB200	DIGITAL LINK SWITCHER	
<input type="checkbox"/> INPUT SELECT <input type="checkbox"/> PICTURE <input type="checkbox"/> POSITION <input type="checkbox"/> LANGUAGE <input type="checkbox"/> OPTION	<input checked="" type="radio"/> HDMI 1	
	<input type="radio"/> HDMI 2	
	<input type="radio"/> COMPUTER 1	
	<input type="radio"/> COMPUTER 2	
	<input type="radio"/> VIDEO	

- Operation is possible with the remote control depending on the connected DIGITAL LINK compatible display (projector or flat panel display). For details, refer to “Operating with the remote control” (➔ page 35).

2) Press ▲▼ to select an item from the main menu item.

- The selected item is highlighted in yellow.
- The sub-menu items of the selected main menu are displayed on the right side.

ET-YFB200	DIGITAL LINK SWITCHER	
<input type="checkbox"/> INPUT SELECT <input checked="" type="checkbox"/> PICTURE <input type="checkbox"/> POSITION <input type="checkbox"/> LANGUAGE <input type="checkbox"/> OPTION	SYSTEM SELECTOR	AUTO
	CLAMP POSITION	<input type="text" value="0"/> +24
	DIGITAL CINEMA REALITY	

3) Press the <ENTER> button.

- The sub-menu items become selectable.

4) Press ▲▼ to select a sub-menu item, and press ◀▶ to change or adjust settings.

- For some items, press ◀▶ to display an individual adjustment screen with a bar scale as shown below.



- A screen to set the detailed setting is displayed by pressing the <ENTER> button for the item with item name only.

Note

- It returns to the menu screen 1 level higher when the <RETURN> button or the <MENU> button is pressed while the menu screen is displayed.
- Depending on the model of the display (projector or flat panel display) in use, the MENU button or the RETURN button may not be present on the remote control.
- Some items cannot be adjusted or some functions cannot be used depending on the signal that is input to the device. The menu items that cannot be adjusted or used are shown in gray characters, and they cannot be selected.
- Some items can be adjusted even if signals are not input.
- Individual adjustment screen is cleared automatically if no operation is performed for approximately 5 seconds.
- For menu items, refer to “Main menu” (➔ page 39) and “Sub-menu” (➔ page 39).

- When 3D signal is output from the device, the menu of the device is not displayed. To change the setting of the device, input the 2D signal or operate without inputting any signal.
- When 3D signal is output from the device, all the setting items in the [PICTURE] menu and the [POSITION] menu are disabled.
- The cursor color depends on the setting in the [OPTION] menu → [ON-SCREEN SETTING] → [OSD DESIGN]. The selected item is displayed with the yellow cursor by default.
- When the [OPTION] menu → [ON-SCREEN SETTING] → [OSD OUTPUT] is set to [DVI-D/DIGITAL LINK], the menu screen (OSD) is not displayed on any image display device screen connected to the <DVI-D OUT> terminal or the <DIGITAL LINK OUT 2> terminal if the connection status is as follows. Operate after turning on the power of the image display device connected to the <DIGITAL LINK OUT 1> terminal.
 - Displays (projector or flat panel display) are connected to both the <DIGITAL LINK OUT 1> terminal and the <DIGITAL LINK OUT 2> terminal.
 - Display connected to the <DIGITAL LINK OUT 1> terminal is in standby mode.
 If the display connected to the <DIGITAL LINK OUT 1> terminal cannot be turned on due to defect, etc., press and hold the <MENU> button on the control panel of this device for 3 seconds or longer. The menu screen is forcefully output to the output image of all the output terminal.

Resetting adjusted values to the factory default

If there is the DEFAULT button on the remote control, the values set and adjusted in the menu item will return to the factory setting when this button is pressed.

1) Press the DEFAULT button on the remote control.

- The operation varies depending on the displayed screen.
 - When the sub-menu screen is displayed
The displayed sub-menu items are restored to the factory default settings.
 - When the individual adjustment screen is displayed
Only items during adjustment are restored to the factory default settings.



Note

- The DEFAULT button may not be present on the remote control depending on the display (projector or flat panel display) in use.
- Returning all the values set and adjusted in the menu item is performed with [OPTION] menu → [INITIALIZE] (➡ page 62).
- The mark above the bar scale in the individual adjustment screen indicates the factory default setting. The position of this mark varies depending on the selected input signals.

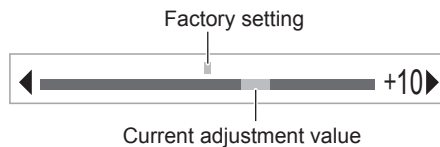

Main menu

The following items are in the main menu.

When a main menu item is selected, the screen changes to a sub-menu selection screen.

Main menu item		Page
	[INPUT SELECT]	39
	[PICTURE]	40
	[POSITION]	40
	[LANGUAGE]	40
	[OPTION]	40

Sub-menu

The sub-menu of the selected main menu item is displayed, and you can set and adjust items in the sub-menu.

[INPUT SELECT]

Details (➡ page 41)

[PICTURE] 

Sub-menu item	Factory default	Page
[SYSTEM SELECTOR]	[AUTO]	42
[CLAMP POSITION]	[24]*1	42
[DIGITAL CINEMA REALITY]	[AUTO]	43

*1 Depends on the signal input.

Note

- The factory default settings may vary depending on the picture mode.
- Displaying of sub-menu items and factory default values differ depending on the selected input terminal.

[POSITION] 

Sub-menu item	Factory default	Page
[SHIFT]	[0]	44
[CLOCK PHASE]	[0]	44
[OVER SCAN]	[0]*1	45
[ASPECT]	[AUTO]*1	45
[INPUT RESOLUTION]	—	45

*1 Depends on the signal input.

Note

- Displaying of sub-menu items and factory default values differ depending on the selected input terminal.

[LANGUAGE] 

Details (➔ page 47)

[OPTION] 

Sub-menu item	Factory default	Page
[ON-SCREEN SETTING]	—	48
[COMPUTER IN]	—	48
[HDMI IN]	—	50
[DIGITAL LINK OUT]	—	52
[DVI-D OUT]	—	53
[CLOSED CAPTION SETTING]	[OFF]	54
[BACK COLOR]	[BLUE]	55
[NO SIGNAL SLEEP]	[10MIN.]	55
[AUDIO SETTING]	—	55
[AUTO SETUP]	—	57
[BACKUP INPUT SETTING]	[OFF]	57
[RS-232C]	—	58
[NETWORK]	—	60
[STATUS]	—	61
[INITIALIZE]	—	62

[INPUT SELECT] menu

Select [INPUT SELECT] from the main menu in the menu screen, and display the sub-menu. Refer to “Navigating through the menu” (➔ page 38) for the operation of the menu screen.

Switching the input

An input terminal for the image can be selected.

- Press ▲▼ to select the input, and press the <ENTER> button.

[HDMI 1]	Switches the input to HDMI 1.
[HDMI 2]	Switches the input to HDMI 2.
[COMPUTER 1]	Switches the input to COMPUTER 1.
[COMPUTER 2]	Switches the input to COMPUTER 2.
[VIDEO]	Switches the input to VIDEO.

Note

- When the power of the device is turned on, the input selected at the last time of use is enabled.
- The input is set to [COMPUTER 1] in the factory default setting, or when [USER DATA] in [INITIALIZE] (➔ page 62) is executed.

[PICTURE] menu

Select [PICTURE] from the main menu, and select the item from the sub-menu.

Refer to “Navigating through the menu” (➔ page 38) for the operation of the menu screen.

- After selecting the item, press ▲▼◀▶ to adjust.

Note

- All the setting items in the [PICTURE] menu are disabled when 3D signal is output from the device.

[SYSTEM SELECTOR]

This device will automatically detect the input signal, but you can set the system method manually when an unstable signal is input. Set the system method matching the input signal.

- 1) Press ▲▼ to select [SYSTEM SELECTOR].
- 2) Press ◀▶ or the <ENTER> button.
 - The [SYSTEM SELECTOR] individual adjustment screen is displayed.
- 3) Press ◀▶ to switch system method.
 - The system method that can be selected will differ depending on the input signal.

Terminals	System method	
<VIDEO IN> terminal	Select [AUTO], [NTSC], [NTSC4.43], [PAL], [PAL-M], [PAL-N], [SECAM], or [PAL60]. Set to [AUTO] normally. (Setting [AUTO] will automatically select [NTSC], [NTSC4.43], [PAL], [PAL-M], [PAL-N], [SECAM], or [PAL60].) Switch the setting to the signal method for the TV used. The NTSC signal method is used in Japan.	
<COMPUTER 1 IN> terminal, <COMPUTER 2 IN> terminal	480i, 576i, 576p signal	Select from [AUTO], [RGB], or [YCbCr].
	VGA60, 480p signal	Select from [AUTO], [VGA60], [480p], or [480p RGB].
	Moving image signal other than above	Select from [AUTO], [RGB], or [YPbPr].
<HDMI 1 IN> terminal, <HDMI 2 IN> terminal	480i, 576i, 480p, 576p signal	Select from [AUTO], [RGB], or [YCbCr].
	Moving image signal other than above	Select from [AUTO], [RGB], or [YPbPr].

Note

- For the compatible signals, refer to “Compatible signals” (➔ page 88).
- This may not function properly for some external devices that are connected.

[CLAMP POSITION]

Adjust the optimal point when the black part of the image is blunt or it has turned green.

- 1) Press ▲▼ to select [CLAMP POSITION].
- 2) Press ◀▶ or the <ENTER> button.
 - The [CLAMP POSITION] individual adjustment screen is displayed.
- 3) Press ◀▶ to adjust.

Condition	Indication of optimal value	Range
When the black part is blunt	The point where bluntness of the black part improves the most is the optimal value.	1 - 255
When the black part is green	The point where the green part becomes black, and the bluntness has improved is the optimal value.	

Note

- Setting value of the [CLAMP POSITION] is reflected to all the video signals output from the <DVI-D OUT> terminal and the <DIGITAL LINK OUT 1> terminal/<DIGITAL LINK OUT 2> terminal. Make adjustment on the image display device connected to each terminal when individual adjustment for each output terminal is required.
- [CLAMP POSITION] can be adjusted only when a signal is input to the <COMPUTER 1 IN> terminal or the <COMPUTER 2 IN> terminal. Also, [CLAMP POSITION] can be adjusted when a signal is input to the <COMPUTER 1 IN> terminal and only when the [COMPUTER 1 INPUT SETTING] is set to [RGB/YPbPr] in the [OPTION] menu → [COMPUTER IN] (➔ page 48).
- Adjustment may not be possible depending on the signal.

[DIGITAL CINEMA REALITY]

The vertical resolution is further raised with the cinema process to enhance the picture quality when 576i signal is input to PAL (or SECAM), and 480i, 1080/50i, or 1080/60i signal is input to NTSC.

- 1) Press ▲▼ to select [DIGITAL CINEMA REALITY].
- 2) Press ◀▶ or the <ENTER> button.
 - The [DIGITAL CINEMA REALITY] individual adjustment screen is displayed.
- 3) Press ◀▶ to switch items.
 - The item is switched every time the button is pressed.

[AUTO]	It will automatically detect and performs cinema process.	
[OFF]	It will not perform cinema process.	
[30p FIXED]	During 480i or 1080/60i signal input	It will become forced cinema process (2:2 pulldown).
[25p FIXED]	During 576i or 1080/50i signal input	

[POSITION] menu

Select [POSITION] from the main menu, and select the item from the sub-menu.

Refer to “Navigating through the menu” (➔ page 38) for the operation of the menu screen.

- After selecting the item, press ▲▼◀▶ to adjust.
- Setting value of each item in the [POSITION] is reflected to all the video signals output from the <DVI-D OUT> terminal and the <DIGITAL LINK OUT 1> terminal/<DIGITAL LINK OUT 2> terminal. Make adjustment on the image display device connected to each terminal when individual adjustment for each output terminal is required.

Note

- All the setting items in the [POSITION] menu are disabled when 3D signal is output from the device.

[SHIFT]

Adjusts the projected or displayed image position.

- When using a projector, confirm that the relative position of the projector and the screen is correctly installed before adjusting the image position.

- 1) Press ▲▼ to select [SHIFT].
- 2) Press the <ENTER> button.
 - The [SHIFT] individual adjustment screen is displayed.
- 3) Press ▲▼◀▶ to adjust the position.

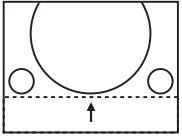
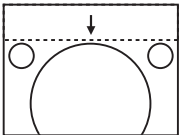
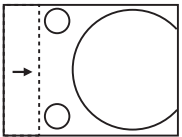
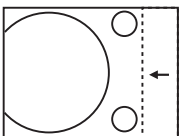
Orientation	Operation	Adjustment	
Vertical (up and down) adjustment	Press ▲.	The image position moves up.	
	Press ▼.	The image position moves down.	
Horizontal (right and left) adjustment	Press ▶.	The image position moves to the right.	
	Press ◀.	The image position moves to the left.	

[CLOCK PHASE]

Adjust the setting to achieve an optimal image when a flickering or smearing edge appears on the image.

- 1) Press ▲▼ to select [CLOCK PHASE].
- 2) Press ◀▶ or the <ENTER> button.
 - The [CLOCK PHASE] individual adjustment screen is displayed.
- 3) Press ◀▶ to adjust.
 - Adjustment value will change between [0] and [+31]. Adjust so that the amount of interference is at a minimum.

Note

- Optimal value may not be achieved if the output from the input computer is unstable.

- Optimal value may not be achieved when there is a shift in the total dot numbers.
- [CLOCK PHASE] can be adjusted only when the signal is input to the <COMPUTER 1 IN> terminal or the <COMPUTER 2 IN> terminal. However, [CLOCK PHASE] cannot be selected when Y/C signal, YC_BC_R signal (480i, 576i), or analog RGB signal (480i, 576i) is input.
- [CLOCK PHASE] cannot be adjusted when video signal or HDMI signal is input.

[OVER SCAN]

- Only when video signal, Y/C signal, YC_BC_R/YP_BP_R signal, analog RGB signal (moving image), or HDMI signal (moving image) is input

Adjust the setting when character or image at the edge of the projected or displayed image is cropped.

- 1) Press ▲▼ to select [OVER SCAN].
- 2) Press ◀▶ or the <ENTER> button.
 - The [OVER SCAN] individual adjustment screen is displayed.
- 3) Press ◀▶ to adjust.
 - Adjustment value is between [0] and [+10].

[ASPECT]

Switch the aspect ratio of the image output from the <DIGITAL LINK OUT 1> terminal, the <DIGITAL LINK OUT 2> terminal, or the <DVI-D OUT> terminal.

- 1) Press ▲▼ to select [ASPECT].
- 2) Press ◀▶ or the <ENTER> button.
 - The [ASPECT] individual adjustment screen is displayed.
- 3) Press ◀▶ to switch items.
 - The item is switched every time the button is pressed.

Aspect mode	Description
[AUTO] ^{*1}	Recognizes the video ID (VID) embedded in the video signal, and outputs the image by automatically switching to 4:3 or 16:9 image size.
[NORMAL]	Maintains the aspect ratio of the input signal and outputs the image so that it is not cropped. Outputs the image using all the vertical display valid region of the connected image display device when the standard signal ^{*2} is input. Outputs the image using all of either the horizontal or the vertical display valid region of the connected image display device when the wide signal ^{*3} is input.
[WIDE]	Outputs the image by converting the aspect ratio to 16:9 or 15:9 when the standard signal ^{*2} is input. Outputs without changing the aspect ratio of the input when the wide signal ^{*3} is input.
[S16:9] ^{*4}	Outputs the image matching 4:3 image size maintaining the aspect ratio when the wide signal ^{*3} is input.
[H FIT]	Outputs the image using all the horizontal display valid region of the connected image display device maintaining the aspect ratio of the input signal.
[V FIT]	Outputs the image using all the vertical display valid region of the connected image display device maintaining the aspect ratio of the input signal.
[FULL]	Outputs the image using all the display valid region of the connected image display device.
[NATIVE]	Displays the image in the resolution of the input signals without changing.

*1 Only when video signal (NTSC), Y/C signal (NTSC), YC_BC_R signal (480i) are input.

*2 Standard signal is a signal with an aspect ratio of 4:3 or 5:4.

*3 Wide signal is a signal with an aspect ratio of 16:10, 16:9, or 15:9.

*4 Only when the wide signal is input.

Note

- The image that is actually displayed may not change depending on the input signal even when the [ASPECT] setting is changed.
- The image may look different from the original image when the aspect ratio is set to different one as the one for input signal. Taking care of this point when setting [ASPECT].
- The copyright of the original copyright owner protected by the copyright laws may be violated when an image is compressed or expanded using the device at cafe, hotel, etc., for a commercial purpose or public presentation. Take caution when using the function of the device such as aspect adjustment.
- Part of the peripheral image may not display or be distorted when a conventional (normal) 4:3 image that is not a wide image is projected or displayed in a wide screen. View the original image respecting the intention of the creator in 4:3 image.

[INPUT RESOLUTION]

Adjust the setting to achieve an optimal image when a flickering or smearing edge appears on the image.

- 1) Press ▲▼ to select [INPUT RESOLUTION].

2) Press the <ENTER> button.

- The [INPUT RESOLUTION] individual adjustment screen is displayed.

3) Press ▲▼ to select [TOTAL DOTS], [DISPLAY DOTS], [TOTAL LINES], or [DISPLAY LINES], and press ◀▶ to adjust each item.

- Values corresponding to the input signal are displayed automatically for each item. Increase or decrease the displayed values and adjust to the optimal condition viewing the screen when there is a vertical banding or missing in the screen.

Note

- Previously mentioned vertical banding will not occur with all white signal input.
- The image may be disrupted while performing the adjustment, but it is not a malfunction.
- [INPUT RESOLUTION] can be adjusted only when the analog RGB signal is input to the <COMPUTER 1 IN> terminal or the <COMPUTER 2 IN> terminal. Adjustment is not possible when the Y/C signal is input.
- Adjustment may not be possible depending on the signal.

[LANGUAGE] menu

On the menu screen, select [LANGUAGE] from the main menu, and display the sub-menu. Refer to “Navigating through the menu” (➔ page 38) for the operation of the menu screen.

Changing the display language

Select the language of the on-screen display.

- Press ▲▼ to select a language, and press the <ENTER> button.

ET-YFB200	DIGITAL LINK SWITCHER	
➔	INPUT SELECT	• ENGLISH
📺	PICTURE	DEUTSCH
📏	POSITION	FRANÇAIS
🗨️	LANGUAGE	ESPAÑOL
🔧	OPTION	日本語

- Various menus, settings, adjustment screens, control button names, etc., are displayed in the selected language.
- It can be switched to English, German, French, Spanish, or Japanese.

Note

- The on-screen display language is set to English in the factory default setting, or when [USER DATA] in the [OPTION] menu → [INITIALIZE] (➔ page 62) is executed.

[OPTION] menu

Select [OPTION] from the main menu, and select the item from the sub-menu.

Refer to “Navigating through the menu” (➔ page 38) for the operation of the menu screen.

- After selecting the item, press ▲▼◀▶ to adjust.

[ON-SCREEN SETTING]

Set the on-screen display.

Setting [OSD DESIGN]

Set the color of the menu screen (OSD).

- 1) Press ▲▼ to select [ON-SCREEN SETTING].
- 2) Press the <ENTER> button.
 - The [ON-SCREEN SETTING] screen is displayed.
- 3) Press ▲▼ to select [OSD DESIGN].
- 4) Press ◀▶ to switch the item.
 - The item is switched every time the button is pressed.

[TYPE1]	Sets to blue.
[TYPE2]	Sets to black.

Setting [OSD OUTPUT]

Set the terminal to output the menu screen (OSD).

- 1) Press ▲▼ to select [ON-SCREEN SETTING].
- 2) Press the <ENTER> button.
 - The [ON-SCREEN SETTING] screen is displayed.
- 3) Press ▲▼ to select [OSD OUTPUT].
- 4) Press ◀▶ to switch items.
 - The item is switched every time the button is pressed.

[DVI-D/DIGITAL LINK]	The menu screen (OSD) is displayed in the output image from the <DVI-D OUT> terminal, the <DIGITAL LINK OUT 1> terminal, and the <DIGITAL LINK OUT 2> terminal.
[DVI-D]	The menu screen (OSD) is displayed only in the output image from the <DVI-D OUT> terminal.

Note

- When the [OSD OUTPUT] is set to [DVI-D/DIGITAL LINK], the menu screen (OSD) is not displayed on any image display device screen connected to the <DVI-D OUT> terminal or the <DIGITAL LINK OUT 2> terminal if the connection status is as follows. Operate after turning on the power of the image display device connected to the <DIGITAL LINK OUT 1> terminal.
 - Displays (projector or flat panel display) are connected to both the <DIGITAL LINK OUT 1> terminal and the <DIGITAL LINK OUT 2> terminal.
 - Display connected to the <DIGITAL LINK OUT 1> terminal is in standby mode.
 If the display connected to the <DIGITAL LINK OUT 1> terminal cannot be turned on due to defect, etc., press and hold the <MENU> button on the control panel of this device for 3 seconds or longer. The menu screen is forcefully output to the output image of all the output terminal.
- The menu screen (OSD) is not displayed when the 3D signal is output from the device.

[COMPUTER IN]

Change the setting if the correct image is not displayed when the Y/C signal is input to the device, or when connected to an external device using the <COMPUTER 1 IN> terminal and the <COMPUTER 2 IN> terminal.

Setting [COMPUTER 1 INPUT SETTING]

Set in accordance to the signal input to the <COMPUTER 1 IN> terminal.

- 1) Press ▲▼ to select [COMPUTER IN].

- 2) Press the <ENTER> button.
 - The [COMPUTER IN] screen is displayed.
- 3) Press ▲▼ to select [COMPUTER 1 INPUT SETTING].
- 4) Press ◀▶ to switch items.
 - The item is switched every time the button is pressed.

[RGB/YP _B P _R]	Select this when the RGB signal or the YC _B C _R /YP _B P _R signal is input to the <COMPUTER 1 IN> terminal.
[Y/C]	Select to input the Y/C signal to the <COMPUTER 1 IN> terminal.

Note

- When the Y/C signal is to be input to the <COMPUTER 1 IN> terminal, use the optional D-SUB - S Video conversion cable (Model No.: ET-ADSV).

Switching the slice level of the input synchronization signal

Set in accordance to the signal input to the <COMPUTER 1 IN> terminal and the <COMPUTER 2 IN> terminal.

- 1) Press ▲▼ to select [COMPUTER IN].
- 2) Press the <ENTER> button.
 - The [COMPUTER IN] screen is displayed.
- 3) Press ▲▼ to select [SYNC SLICE LEVEL].
- 4) Press ◀▶ to switch items.
 - The item is switched every time the button is pressed.

[LOW]	Sets the slice level to [LOW].
[HIGH]	Sets the slice level to [HIGH].

Setting [COMPUTER 2 EDID MODE]

Set the EDID (extended display identification data) of the computer 2 input.

- 1) Press ▲▼ to select [COMPUTER IN].
- 2) Press the <ENTER> button.
 - The [COMPUTER IN] screen is displayed.
- 3) Press ▲▼ to select [COMPUTER 2 EDID MODE].
- 4) Press ◀▶ to switch items.
 - The item is switched every time the button is pressed.

[DEFAULT]	This is the default setting.
[COPY]	Changes the EDID in accordance with the display (projector or flat panel display) connected to the <DIGITAL LINK OUT 1> terminal or the <DIGITAL LINK OUT 2> terminal.
[USER]	Sets the [RESOLUTION] and [VERTICAL SCAN FREQUENCY] items to EDID.

- When [DEFAULT] or [COPY] is selected, advance to Step 13).

- 5) Press ▲▼ to select [RESOLUTION].
- 6) Press the <ENTER> button.
 - The [RESOLUTION] screen is displayed.
- 7) Press ▲▼ to select [RESOLUTION].
 - Select [1024x768p], [1280x720p], [1280x768p], [1280x800p], [1280x1024p], [1366x768p], [1400x1050p], [1440x900p], [1600x900p], [1600x1200p], [1680x1050p], [1920x1080p], [1920x1080i], or [1920x1200p].
- 8) Press the <ENTER> button.

- 9) Press the <RETURN> button.
 - The screen returns to the [COMPUTER IN] screen.
- 10) Press ▲▼ to select [VERTICAL SCAN FREQUENCY].
- 11) Press the <ENTER> button.
 - The [VERTICAL SCAN FREQUENCY] screen is displayed.
- 12) Press ▲▼ to select [VERTICAL SCAN FREQUENCY].
 - When [1920x1080p] is selected for [RESOLUTION], select [60Hz], [50Hz], [30Hz], [25Hz], or [24Hz].
 - Select [60Hz], [50Hz], or [48Hz] when [1920x1080i] is selected for [RESOLUTION].
 - Select [60Hz] or [50Hz] when anything other than [1920x1080p] or [1920x1080i] is selected for [RESOLUTION].
- 13) Press the <ENTER> button.
- 14) Press the <RETURN> button.
 - The screen returns to the [COMPUTER IN] screen.
- 15) Press ▲▼ to select [STORE], and press the <ENTER> button.

Note

- [COMPLETE] is displayed when the setting is correctly saved, and [INCOMPLETE] is displayed when the setting was not saved.
- The changed settings are displayed in the [RESOLUTION] and [VERTICAL SCAN FREQUENCY] of [EDID STATUS].
- When displays (projector or flat panel display) are connected to both the <DIGITAL LINK OUT 1> terminal and the <DIGITAL LINK OUT 2> terminal of the device, and [COMPUTER 2 EDID MODE] is set to [COPY], EDID is changed in accordance with the display connected to the <DIGITAL LINK OUT 1> terminal.
- Setting cannot be saved even if [COMPUTER 2 EDID MODE] is set to [COPY] while a display (projector or flat panel display) with a resolution not listed in “Compatible signals” (➔ page 88) is connected.
- To set [COMPUTER 2 EDID MODE] to [USER], set [RESOLUTION] and [VERTICAL SCAN FREQUENCY] combination referring to “Compatible signals” (➔ page 88). Setting cannot be saved when it is set with the combination not listed in “Compatible signals”.
- Setting of the resolution and vertical scanning frequency may also be necessary on the computer or image input device in use.
- It may be necessary to reboot the computer, the image input device, or this device after setting.
- It may not be able to output the image in the set resolution or vertical scanning frequency depending on the computer or the image input device in use.
- The setting of EDID for the computer 1 input cannot be changed.

[HDMI IN]

Set the EDID (extended display identification data) of the HDMI 2 input. Switch the setting when correct image is not displayed when it is connected to the external device using the <HDMI 2 IN> terminal.

- 1) Press ▲▼ to select [HDMI IN].
- 2) Press the <ENTER> button.
 - The [HDMI IN] screen is displayed.
- 3) Press ▲▼ to select [HDMI 2 EDID MODE].
- 4) Press ◀▶ to switch items.
 - The item is switched every time the button is pressed.

[DEFAULT]	This is the default setting.
[COPY]	Changes the EDID in accordance with the display (projector or flat panel display) connected to the <DIGITAL LINK OUT 1> terminal or the <DIGITAL LINK OUT 2> terminal.
[USER]	Sets the [RESOLUTION] and [VERTICAL SCAN FREQUENCY] items to EDID.

- When [DEFAULT] or [COPY] is selected, advance to Step 13).
- 5) Press ▲▼ to select [RESOLUTION].
 - 6) Press the <ENTER> button.
 - The [RESOLUTION] screen is displayed.
 - 7) Press ▲▼ to select [RESOLUTION].
 - Select [1024x768p], [1280x720p], [1280x768p], [1280x800p], [1280x1024p], [1366x768p], [1400x1050p], [1440x900p], [1600x900p], [1600x1200p], [1680x1050p], [1920x1080p], [1920x1080i], or [1920x1200p].

- 8) Press the <ENTER> button.
- 9) Press the <RETURN> button.
 - The screen returns to the [HDMI IN] screen.
- 10) Press ▲▼ to select [VERTICAL SCAN FREQUENCY].
- 11) Press the <ENTER> button.
 - The [VERTICAL SCAN FREQUENCY] screen is displayed.
- 12) Press ▲▼ to select [VERTICAL SCAN FREQUENCY].
 - When [1920x1080p] is selected for [RESOLUTION], select [60Hz], [50Hz], [30Hz], [25Hz], or [24Hz].
 - Select [60Hz], [50Hz], or [48Hz] when [1920x1080i] is selected for [RESOLUTION].
 - Select [60Hz] or [50Hz] when anything other than [1920x1080p] or [1920x1080i] is selected for [RESOLUTION].
- 13) Press the <ENTER> button.
- 14) Press the <RETURN> button.
 - The screen returns to the [HDMI IN] screen.
- 15) Press ▲▼ to select [STORE], and press the <ENTER> button.

Note

- [COMPLETE] is displayed when the setting is correctly saved, and [INCOMPLETE] is displayed when the setting was not saved.
- The changed settings are displayed in the [RESOLUTION] and [VERTICAL SCAN FREQUENCY] of [EDID STATUS].
- When displays (projector or flat panel display) are connected to both the <DIGITAL LINK OUT 1> terminal and the <DIGITAL LINK OUT 2> terminal of the device, and [HDMI 2 EDID MODE] is set to [COPY], EDID is changed in accordance with the display connected to the <DIGITAL LINK OUT 1> terminal.
- Setting cannot be saved even if [HDMI 2 EDID MODE] is set to [COPY] while a display (projector or flat panel display) with a resolution not listed in “Compatible signals” (➔ page 88) is connected.
- To set [HDMI 2 EDID MODE] to [USER], set [RESOLUTION] and [VERTICAL SCAN FREQUENCY] combination referring to “Compatible signals” (➔ page 88). Setting cannot be saved when it is set with the combination not listed in “Compatible signals”.
- Setting of the resolution and vertical scanning frequency may also be necessary on the computer or image input device in use.
- It may be necessary to reboot the computer, the image input device, or this device after setting.
- It may not be able to output the image in the set resolution or vertical scanning frequency depending on the computer or the image input device in use.
- The setting of EDID for the HDMI 1 input cannot be changed.

[DIGITAL LINK OUT]

Perform the setting of the output signal from the <DIGITAL LINK OUT 1> terminal and the <DIGITAL LINK OUT 2> terminal.

- 1) Press ▲▼ to select [DIGITAL LINK OUT].
- 2) Press the <ENTER> button.
 - The [DIGITAL LINK OUT] screen is displayed.
- 3) Press ▲▼ to select [FRAME LOCK].
- 4) Press ◀▶ to switch items.
 - The item is switched every time the button is pressed.

[OFF]	Disables [FRAME LOCK].
[ON]	<p>Synchronizes the output signal from the <DIGITAL LINK OUT 1> terminal and the <DIGITAL LINK OUT 2> terminal with the vertical scanning frequency when a moving image signal is input, preventing the image from being jumpy due to frame jump.</p> <p>The output resolution is automatically set by the input signal.</p> <ul style="list-style-type: none"> • Image is output with the same resolution as the input signal when 720p signal/1080p signal is input. 720p signal: 720/60p, 720/50p 1080p signal: 1080/24p, 1080/25p, 1080/30p, 1080/60p, 1080/50p • Image is output with the resolution of 1 920 x 1 080 dots when a video signal other than the 720p signal/1080p signal is input. Target signal: NTSC/NTSC4.43/PAL-M/PAL60, PAL/PAL-N/SECAM, 480i, 576i, 480p, 576p, 1080/60i, 1080/50i • Image is output by automatically adjusting to the resolution of the display (projector or flat panel display) connected to the <DIGITAL LINK OUT 1> terminal or the <DIGITAL LINK OUT 2> terminal when a still image signal is input. However, if the resolution of the display cannot be determined, the image is output in resolution of 1 920 x 1 080 dots.

- When [OFF] is selected, advance to Step 5).

- 5) Press ▲▼ to select [OUTPUT RESOLUTION].
- 6) Press the <ENTER> button.
 - The [OUTPUT RESOLUTION] screen is displayed.
- 7) Press ▲▼ to switch items.
 - The item is switched every time the button is pressed.

[AUTO]	Outputs the image by automatically adjusting to the resolution of the display (projector or flat panel display) connected to the <DIGITAL LINK OUT 1> terminal or the <DIGITAL LINK OUT 2> terminal.
[1920x1200]	Outputs the image in 1 920 x 1 200 dots.
[1920x1080]	Outputs the image in 1 920 x 1 080 dots.
[1400x1050]	Outputs the image in 1 400 x 1 050 dots.
[1366x768]	Outputs the image in 1 366 x 768 dots.
[1280x800]	Outputs the image in 1 280 x 800 dots.
[1024x768]	Outputs the image in 1 024 x 768 dots.

Note

- Image may not display depending on the connected image display device when [OUTPUT RESOLUTION] is set to anything other than [AUTO]. In such case, press the <RETURN> button on the control panel 4 times, and then press the <ENTER> button and the <RETURN> button simultaneously to forcefully change [OUTPUT RESOLUTION] to [AUTO] for both [DIGITAL LINK OUT] and [DVI-D OUT].
- Image is output with appropriate resolution and tone for the connected display when [FRAME LOCK] is set to [ON], but it may take some time for the image to be output at the time of switching the input or switching the signal.
- To output the 3D signal, set [FRAME LOCK] to [ON]. 3D signal is not output when set to [OFF].
- [OUTPUT RESOLUTION] cannot be set when [FRAME LOCK] is set to [ON].
- When the displays are connected to both the <DIGITAL LINK OUT 1> terminal and the <DIGITAL LINK OUT 2> terminal, and [FRAME LOCK] is set to [ON] to input the still image signal, the image is output matching the resolution of the display connected to the <DIGITAL LINK OUT 1> terminal.
- When the displays (projector or flat panel display) are connected to both the <DIGITAL LINK OUT 1> terminal and the <DIGITAL LINK OUT 2> terminal of the device and [OUTPUT RESOLUTION] is set to [AUTO], the image is output matching the resolution of the display connected to the <DIGITAL LINK OUT 1> terminal.
- When [FRAME LOCK] is set to [ON], the [OPTION] menu → [BACKUP INPUT SETTING] (➡ page 57) cannot be set.

[DVI-D OUT]

Perform the setting of the output signal from the <DVI-D OUT> terminal.

- 1) Press ▲▼ to select [DVI-D OUT].
- 2) Press the <ENTER> button.
 - The [DVI-D OUT] screen is displayed.
- 3) Press ▲▼ to select [FRAME LOCK].
- 4) Press ◀▶ to switch items.
 - The item is switched every time the button is pressed.

[OFF]	Disables [FRAME LOCK].
[ON]	<p>Synchronizes the output signal from the <DVI-D OUT> terminal with the vertical scanning frequency when a moving image signal is input, preventing the image from being jumpy due to frame jump. The output resolution is automatically set by the input signal.</p> <ul style="list-style-type: none"> • Image is output with the same resolution as the input signal when 720p signal/1080p signal is input. 720p signal: 720/60p, 720/50p 1080p signal: 1080/24p, 1080/25p, 1080/30p, 1080/60p, 1080/50p • Image is output with the resolution of 1 920 x 1 080 dots when a moving image signal other than the 720p signal/1080p signal is input. Target signal: NTSC/NTSC4.43/PAL-M/PAL60, PAL/PAL-N/SECAM, 480i, 576i, 480p, 576p, 1080/60i, 1080/50i • Image is output by automatically adjusting to the resolution of the image display device connected to the <DVI-D OUT> terminal when a still image signal is input. However, if the resolution of the image display device cannot be determined, the image is output in resolution of 1 920 x 1 080 dots.

- When [OFF] is selected, advance to Step 5).

- 5) Press ▲▼ to select [OUTPUT RESOLUTION].
- 6) Press the <ENTER> button.
 - The [OUTPUT RESOLUTION] screen is displayed.
- 7) Press ▲▼ to switch items.
 - The item is switched every time the button is pressed.

[AUTO]	Outputs the image by automatically adjusting to the resolution of the image display device connected to the <DVI-D OUT> terminal.
[1920x1200]	Outputs the image in 1 920 x 1 200 dots.
[1920x1080]	Outputs the image in 1 920 x 1 080 dots.
[1400x1050]	Outputs the image in 1 400 x 1 050 dots.
[1366x768]	Outputs the image in 1 366 x 768 dots.
[1280x800]	Outputs the image in 1 280 x 800 dots.
[1024x768]	Outputs the image in 1 024 x 768 dots.

Note

- Image may not be displayed depending on the connected image display device when [OUTPUT RESOLUTION] is set to anything other than [AUTO]. In such case, press the <RETURN> button on the control panel 4 times, and then press the <ENTER> button and the <RETURN> button simultaneously to forcefully change [OUTPUT RESOLUTION] to [AUTO] for both [DVI-D OUT] and [DIGITAL LINK OUT].
- Image is output with appropriate resolution and tone for the connected image display device when [FRAME LOCK] is set to [ON], but it may take some time for the image to be output at the time of switching the input or switching the signal.
- [OUTPUT RESOLUTION] cannot be set when [FRAME LOCK] is set to [ON].
- The <DVI-D OUT> terminal does not support the output of 3D signal.
- When [FRAME LOCK] is set to [ON], the [OPTION] menu → [BACKUP INPUT SETTING] (➡ page 57) cannot be set.

Setting the audio output for cascade connection

Set the audio signal output from the <DVI-D OUT> terminal when cascade connection (multiple device connection) is performed with the device.

The [CASCADE] setting is enabled when [AUDIO OUT SELECT] is set to [DIGITAL LINK].

- 1) Press ▲▼ to select [DVI-D OUT].

- 2) Press the <ENTER> button.
 - The [DVI-D OUT] screen is displayed.
- 3) Press ▲▼ to select [CASCADE].
- 4) Press ◀▶ to switch items.
 - The item is switched every time the button is pressed.

[OFF]	Does not output the audio signal from the <DVI-D OUT> terminal.
[ON]	Outputs the audio signal superimposed on the video signal from the <DVI-D OUT> terminal.

Note

- When [CASCADE] is set to [ON], the audio from the audio input set in [AUDIO IN SELECT] is output. For details, refer to [AUDIO SETTING] (➡ page 55).
- When playing back the same image with audio on multiple displays (projector or flat panel display) simultaneously by connecting this device in cascade, the misalignment of the played back audio may be obvious depending on the viewing or listening position. For details, refer to “When performing cascade connection for this device” (➡ page 26).

[CLOSED CAPTION SETTING] (only when NTSC or 480i YC_BC_R signal is input)

Set closed captions.

Selecting to display the closed caption

- 1) Press ▲▼ to select [CLOSED CAPTION SETTING].
- 2) Press the <ENTER> button.
 - The [CLOSED CAPTION SETTING] screen is displayed.
- 3) Press ▲▼ to select [CLOSED CAPTION].
- 4) Press ◀▶ to switch items.
 - The item is switched every time the button is pressed.

[OFF]	Hides closed captions.
[ON]	Displays closed captions.

Setting the closed caption mode

- 1) Press ▲▼ to select [CLOSED CAPTION SETTING].
- 2) Press the <ENTER> button.
 - The [CLOSED CAPTION SETTING] screen is displayed.
- 3) Press ▲▼ to select [MODE].
 - When [CLOSED CAPTION] is set to [OFF], [MODE] cannot be selected.
- 4) Press ◀▶ to switch items.
 - The item is switched every time the button is pressed.

[CC1]	Displays CC1 data.
[CC2]	Displays CC2 data.
[CC3]	Displays CC3 data.
[CC4]	Displays CC4 data.

Note

- Closed caption is a function that displays text information of video signals mainly used in North America. Captions may not be displayed depending on the connected devices or contents being played back.
- [CLOSED CAPTION SETTING] can be selected only when NTSC, 480i YC_BC_R signal is input.
- Closed captions are not displayed when the menu screen is displayed.

[BACK COLOR]

The color of the output image when the video signal is not input in the selected input terminal is set.

- 1) Press ▲▼ to select [BACK COLOR].
- 2) Press ◀▶ to switch the item.
 - The item is switched every time the button is pressed.

[BLUE]	Outputs a video signal with blue on full area.
[BLACK]	Outputs a video signal with black on full area.

[NO SIGNAL SLEEP]

This is a function to automatically stop the output of a signal from the <DIGITAL LINK OUT 1> terminal/<DIGITAL LINK OUT 2> terminal and the <DVI-D OUT> terminal when no video signal is input into the selected input terminal continuously. The time until the signal output is stopped can be set.

By enabling this function, the power consumption of this device can be reduced, and the power save function of the connected image display device can also be utilized.

- 1) Press ▲▼ to select [NO SIGNAL SLEEP].
- 2) Press ◀▶ to switch the item.
 - The item is switched every time the button is pressed.

[10MIN.]	Stops output of the signal when no signal is input for 10 minutes.
[20MIN.]	Stops output of the signal when no signal is input for 20 minutes.
[30MIN.]	Stops output of the signal when no signal is input for 30 minutes.
[OFF]	Disables [NO SIGNAL SLEEP].

Note

- The signal output is resumed in following cases.
 - When a video signal is input to the selected input terminal while the signal is stopped.
 - When the button on the control panel is operated.
 - When the operation to display the on-screen menu of the device is performed.
- To transfer the user logo to the projector by using the Logo Transfer Software, turn this function to [OFF] before transferring. When the output is stopped for longer than the set time, the communication will be shut down and the user logo may not be transferred properly.
- Regardless of the setting of [NO SIGNAL SLEEP], output of the audio corresponding to the input will stop when the video signal for the selected input terminal stops.

[AUDIO SETTING]

Set the details of the sound function.

Adjusting volume

Adjust the volume output from the <AUDIO OUT> terminal.

- 1) Press ▲▼ to select [AUDIO SETTING].
- 2) Press the <ENTER> button.
 - The [AUDIO SETTING] screen is displayed.
- 3) Press ▲▼ to select [VOLUME].
- 4) Press ◀▶ to adjust the level.

Operation	Adjustment	Range
Press ▶.	Increases the volume.	0 - 63
Press ◀.	Decreases the volume.	

Note

- When [AUDIO OUT SELECT] is set to [OFF] or [DIGITAL LINK], [VOLUME] cannot be adjusted.

Adjusting the audio balance

Adjust the balance of the audio output from the <AUDIO OUT> terminal.

- 1) Press ▲▼ to select [AUDIO SETTING].
- 2) Press the <ENTER> button.
 - The [AUDIO SETTING] screen is displayed.
- 3) Press ▲▼ to select [BALANCE].
- 4) Press ◀▶ to adjust the level.

Operation	Adjustment	Range
Press ▶.	Increases the volume for right side.	L16 - R16
Press ◀.	Increases the volume for left side.	

Note

- When [AUDIO OUT SELECT] is set to [OFF] or [DIGITAL LINK], [BALANCE] cannot be adjusted.

Setting the output of audio

Set the terminal to output the audio signal.

- 1) Press ▲▼ to select [AUDIO SETTING].
- 2) Press the <ENTER> button.
 - The [AUDIO SETTING] screen is displayed.
- 3) Press ▲▼ to select [AUDIO OUT SELECT].
- 4) Press ◀▶ to switch items.
 - The item is switched every time the button is pressed.

[DIGITAL LINK]	Outputs the audio signal from the <DIGITAL LINK OUT 1> terminal and the <DIGITAL LINK OUT 2> terminal.
[AUDIO OUT]	Outputs the audio signal from the <AUDIO OUT> terminal.
[OFF]	Does not output the audio signal.

Note

- The audio signal cannot be output from both the <DIGITAL LINK OUT 1> terminal/<DIGITAL LINK OUT 2> terminal and the <AUDIO OUT> terminal.

Setting the source of audio

Set the audio input for each video input terminal.

- 1) Press ▲▼ to select [AUDIO SETTING].
- 2) Press the <ENTER> button.
 - The [AUDIO SETTING] screen is displayed.
- 3) Press ▲▼ to select [AUDIO IN SELECT].
- 4) Press the <ENTER> button.
 - The [AUDIO IN SELECT] screen is displayed.
- 5) Press ▲▼ to select the audio input.
 - Select from [HDMI 1], [HDMI 2], [COMPUTER 1], [COMPUTER 2], or [VIDEO].
- 6) Press ◀▶ to switch items.
 - The item is switched every time the button is pressed.

[HDMI 1 AUDIO IN]	Outputs the audio from the <HDMI 1 IN> terminal when a video signal is input to the selected input terminal. <ul style="list-style-type: none"> • This is displayed only when [HDMI 1] is selected in Step 5).
-------------------	---

[HDMI 2 AUDIO IN]	Outputs the audio from the <HDMI 2 IN> terminal when a video signal is input to the selected input terminal. • This is displayed only when [HDMI 2] is selected in Step 5).
[AUDIO IN 1]	Outputs the audio from the <AUDIO IN 1> terminal when a video signal is input to the selected input terminal.
[AUDIO IN 2]	Outputs the audio from the <AUDIO IN 2> terminal when a video signal is input to the selected input terminal.
[AUDIO IN 3]	Outputs the audio from the <AUDIO IN 3> terminal when a video signal is input to the selected input terminal.
[OFF]	Does not output the audio.

Note

- Audio is output only when a video signal is input to the selected input terminal.

[AUTO SETUP]

Set the operation of the automatic setup function.

When the automatic setup function is operated, image position, clock phase, or resolution when the analog RGB signal that is constructed with dots such as the computer signal is input, or the image position when the HDMI signal is input is automatically adjusted.

- 1) Press ▲▼ to select [AUTO SETUP].
- 2) Press the <ENTER> button.
 - The [AUTO SETUP] screen is displayed.
- 3) Press ▲▼ to select [AUTO SETUP SETTING].
- 4) Press ◀▶ to switch the item.
 - The item is switched every time the button is pressed.

[MANUAL]	Manually operates the automatic setup function.
[AUTO]	Automatically operates the automatic setup function when the input signal is switched.

- When [MANUAL] is selected, advance to Step 5).
- 5) Press ▲▼ to select [AUTO SETUP], and press the <ENTER> button.
 - Automatic setup function will operate.

Note

- This function operates only when analog RGB signal (still image) or HDMI signal (still image and moving image) is input.
- When the automatic setup function is to be operated by setting [MANUAL], it is recommended to input an image with bright white border at the edges and include black and white characters that are high in contrast. Image such as photograph or computer graphic with halftone is not appropriate.

[BACKUP INPUT SETTING]

Set the backup function to automatically switch the signal from the backup input when input signal is disrupted.

- 1) Press ▲▼ to select [BACKUP INPUT SETTING].
- 2) Press the <ENTER> button.
 - The [BACKUP INPUT SETTING] screen is displayed.
- 3) Press ▲▼ to select [BACKUP INPUT MODE].
- 4) Press ◀▶ to switch items.
 - The item is switched every time the button is pressed.

[OFF]	Disables the backup function.
[1]	Enables the backup function and switches to the secondary input automatically when the input signal for primary input is disrupted. Primary input is fixed to the <HDMI 1 IN> terminal, and the secondary input is fixed to the <HDMI 2 IN> terminal.

[2]	Enables the backup function and switches to the secondary input automatically when the input signal for primary input is disrupted. Primary input is fixed to the <HDMI 2 IN> terminal, and the secondary input is fixed to the <HDMI 1 IN> terminal.
-----	--

Note

- To switch to the backup input (secondary input) signal using the backup function, fulfilling of the following 3 conditions are required to use the function.
 - Set [BACKUP INPUT MODE] to [1] or [2].
 - Input the same signal to the primary and secondary inputs.
 - Select primary input.
- When the input is automatically switched to the secondary input with the backup function, the current input (secondary input) will be maintained even when the primary input signal is restored.
- [BACKUP INPUT SETTING] cannot be set when the [OPTION] menu → [DIGITAL LINK OUT] (➔ page 52) → [FRAME LOCK] is set to [ON], or when the [OPTION] menu → [DVI-D OUT] (➔ page 53) → [FRAME LOCK] is set to [ON]. The backup operation is not performed.

[RS-232C]

Set the ID number of the device, and communication condition of the <SERIAL IN> terminal and the <DIGITAL LINK OUT 1> terminal/<DIGITAL LINK OUT 2> terminal.

For the connection example of the display (projector or flat panel display), communication cable specification, and control command, refer to “<SERIAL IN> terminal” (➔ page 83).

Setting [ID]

Set the ID number of the device.

When the system is made up of multiple devices, such as connecting the display (projector or flat panel display) via the <DIGITAL LINK OUT 1> terminal/<DIGITAL LINK OUT 2> terminal of this device, controlling with each ID number from a single computer is possible by setting individual/shared ID number.

- 1) Press ▲▼ to select [RS-232C].
- 2) Press the <ENTER> button.
 - The [RS-232C] screen is displayed.
- 3) Press ▲▼ to select [ID].
- 4) Press ◀▶ to switch items.
 - The item is switched every time the button is pressed.

[1] - [6]	Select the ID number.
-----------	-----------------------

Setting [(IN)BAUDRATE]

Sets the communication speed of the <SERIAL IN> terminal.

- 1) Press ▲▼ to select [RS-232C].
- 2) Press the <ENTER> button.
 - The [RS-232C] screen is displayed.
- 3) Press ▲▼ to select [(IN)BAUDRATE].
- 4) Press ◀▶ to switch items.
 - The item is switched every time the button is pressed.

[9600]	Select the appropriate speed.
[19200]	
[38400]	

Setting [(IN)PARITY]

Set the parity of the <SERIAL IN> terminal.

- 1) Press ▲▼ to select [RS-232C].

- 2) Press the <ENTER> button.
 - The [RS-232C] screen is displayed.
- 3) Press ▲▼ to select [(IN)PARITY].
- 4) Press ◀▶ to switch items.
 - The item is switched every time the button is pressed.

[NONE]	Sets the condition of parity.
[EVEN]	
[ODD]	

Setting [(OUT)PARITY]

Set the communication condition for the <DIGITAL LINK OUT 1> terminal and the <DIGITAL LINK OUT 2> terminal.

- 1) Press ▲▼ to select [RS-232C].
- 2) Press the <ENTER> button.
 - The [RS-232C] screen is displayed.
- 3) Press ▲▼ to select [(OUT)PARITY].
- 4) Press ◀▶ to switch items.
 - The item is switched every time the button is pressed.

[NONE]	Select the parity condition.
[EVEN]	
[ODD]	

Note

- The parity settings for the <DIGITAL LINK OUT 1> terminal and the <DIGITAL LINK OUT 2> terminal are shared. Also check the communication condition (parity setting) of the serial terminal for the display connecting to each terminal.

Setting [RESPONSE(ID ALL)]

Set the response of this device when the “ID ALL” command is received.

- 1) Press ▲▼ to select [RS-232C].
- 2) Press the <ENTER> button.
 - The [RS-232C] screen is displayed.
- 3) Press ▲▼ to select [RESPONSE(ID ALL)].
- 4) Press ◀▶ to switch items.
 - The item is switched every time the button is pressed.

[OFF]	Does not return the response when the “ID ALL” command is received.
[ON]	Returns the response when the “ID ALL” command is received.

Setting [CONTROL(ID ALL)]

Set the control of this device when the “ID ALL” command is received.

- 1) Press ▲▼ to select [RS-232C].
- 2) Press the <ENTER> button.
 - The [RS-232C] screen is displayed.
- 3) Press ▲▼ to select [CONTROL(ID ALL)].
- 4) Press ◀▶ to switch items.
 - The item is switched every time the button is pressed.

[DISABLE]	Does not control the device by command when the "ID ALL" command is received.
[ENABLE]	Controls the device by command when the "ID ALL" command is received.

Setting [GROUP]

Set the group of this device. Control of the device by command is performed when the ID designation in the command matches.

When the system is made up of multiple devices, such as connecting the display (projector or flat panel display) via the <DIGITAL LINK OUT 1> terminal/<DIGITAL LINK OUT 2> terminal of this device, devices in the same group can be controlled simultaneously.

- 1) Press ▲▼ to select [RS-232C].
- 2) Press the <ENTER> button.
 - The [RS-232C] screen is displayed.
- 3) Press ▲▼ to select [GROUP].
- 4) Press ◀▶ to switch items.
 - The item is switched every time the button is pressed.

[A] - [Z]	Select the group.
-----------	-------------------

Setting [RESPONSE(GROUP)]

Set the control of this device when the "ID GROUP" command is received.

- 1) Press ▲▼ to select [RS-232C].
- 2) Press the <ENTER> button.
 - The [RS-232C] screen is displayed.
- 3) Press ▲▼ to select [RESPONSE(GROUP)].
- 4) Press ◀▶ to switch items.
 - The item is switched every time the button is pressed.

[ON]	Returns the response when the "ID GROUP" command is received.
[OFF]	Does not return the response when the "ID GROUP" command is received.

[NETWORK]

Perform the setting of the network function.

Setting [NETWORK SETUP]

Perform the initial setting of the network before using the network function.

- 1) Press ▲▼ to select [NETWORK].
- 2) Press the <ENTER> button.
 - The [NETWORK] screen is displayed.
- 3) Press ▲▼ to select [NETWORK SETUP].
- 4) Press the <ENTER> button.
 - The [NETWORK SETUP] screen is displayed.
- 5) Press ▲▼ to select each item, and change the setting following the instruction of the menu.

[DHCP]	[ON]	Automatically acquires an IP address when a DHCP server exists in the network connected by the <LAN> terminal of this device.
	[OFF]	Perform the [IP ADDRESS], the [SUBNET MASK], and the [DEFAULT GATEWAY] settings when a DHCP server does not exist in the network connected by the <LAN> terminal of this device.
[IP ADDRESS]	Enter the IP address when a DHCP server is not used.	

[SUBNET MASK]	Enter the subnet mask when a DHCP server is not used.
[DEFAULT GATEWAY]	Enter the default gateway address when a DHCP server is not used.
[STORE]	Saves the current network setting.

6) Press ▲▼ to select [STORE], and press the <ENTER> button.

Note

- If a DHCP server is to be used, confirm that the DHCP server is running.
- Check with the network administrator for the IP address, subnet mask, and default gateway.

Setting [NETWORK CONTROL]

Set the control method of the network.

- 1) Press ▲▼ to select [NETWORK].
- 2) Press the <ENTER> button.
 - The [NETWORK] screen is displayed.
- 3) Press ▲▼ to select [NETWORK CONTROL].
- 4) Press the <ENTER> button.
 - The [NETWORK CONTROL] screen is displayed.
- 5) Press ▲▼ to select each item, and press ◀▶ to change the setting.

[WEB CONTROL]	To use the web control, and to use the browser remote control, set to [ON]. For details, refer to "Using the web control function" (➔ page 66), "Using the browser remote control" (➔ page 73).
[PjLink CONTROL]	Set to [ON] to control with the PjLink protocol.
[COMMAND CONTROL]	Set to [ON] to control with control command format (➔ page 86) of the <SERIAL IN> terminal. For details, refer to "Control commands via LAN" (➔ page 80).
[COMMAND PORT]	Sets the port number to use with the command control.
[STORE]	Saves the current network control setting.

6) Press ▲▼ to select [STORE], and press the <ENTER> button.

Displaying [NETWORK STATUS]

Display the network status of the device.

- 1) Press ▲▼ to select [NETWORK].
- 2) Press the <ENTER> button.
 - The [NETWORK] screen is displayed.
- 3) Press ▲▼ to select [NETWORK STATUS].
- 4) Press the <ENTER> button.
 - The [NETWORK STATUS] screen is displayed.

[DHCP]	Displays the usage status of the DHCP server.
[IP ADDRESS]	Displays [IP ADDRESS].
[SUBNET MASK]	Displays [SUBNET MASK].
[DEFAULT GATEWAY]	Displays [DEFAULT GATEWAY].
[DNS1]	Displays the address of the preferred DNS server.
[DNS2]	Displays the address of the alternate DNS server.
[MAC ADDRESS]	Displays [MAC ADDRESS].

[STATUS]

Display the status of the device.

- 1) Press ▲▼ to select [STATUS].

2) Press the <ENTER> button.

- The [STATUS] screen is displayed.

[INPUT SIGNAL]	[NAME]	Displays the input signal name.
	[FREQUENCY]	Displays the frequency of the input signal.
[OUTPUT SIGNAL]	[NAME]	Displays the output signal name.
	[FREQUENCY]	Displays the frequency of the output signal.
[SERIAL NUMBER]	[ET-YFB200]	Displays the serial number of the device.

[INITIALIZE]

Return various setting values to their factory default settings.

After executing this operation, turn off and then turn on the <POWER> button of the device.

1) Press ▲▼ to select [INITIALIZE].

2) Press the <ENTER> button.

- The [INITIALIZE] screen is displayed.

3) Press ▲▼ to select the item to initialize.

[USER DATA]	Returns various setting values to their factory default settings except [NETWORK SETUP].
[NETWORK]	Returns [NETWORK SETUP] to the factory setting.

4) Press the <ENTER> button.

- A message [To do the initialization, the unit will need to be turned off.] is displayed.

5) Press ◀▶ to select [OK], and press the <ENTER> button.

- [Please turn off the DIGITAL LINK switcher, then turn it back on again.] is displayed.

6) Press the <POWER> button to turn off the power.

7) Press the <POWER> button again to turn on the power.

- All input terminal indicators will light up during the initialization. Wait until all input terminal indicators other than the selected input terminal turn off.

For the details regarding input terminal indicator, refer to “Control panel” (➡ page 17).

Note

- Input is set to COMPUTER 1 when [USER DATA] is executed.

Chapter 5 Network control function

This chapter describes the network control function.

Network connection

This device is equipped with a network function, and following are possible by connecting with a computer.

- **Web control**

Setting, adjustment, and status display of this device are possible by accessing this device from a computer. For details, refer to “Using the web control function” (➔ page 66).

- **Browser remote control**

This device can be operated with the operation panel displayed on the web browser. For details, refer to “Using the browser remote control” (➔ page 73).

- **PJLink**

Operation or status query of this device is possible from the computer using the PJLink protocol. For details, refer to “PJLink protocol” (➔ page 79).

- **Command control**

Operation or status query of this device is possible from the computer using the control command. For details, refer to “Control commands via LAN” (➔ page 80).

This device is equipped with a function to send the Ethernet signal via LAN cable together with video and audio signals to the DIGITAL LINK compatible display (projector or flat panel display).

For details, refer to “DIGITAL LINK” (➔ page 13), “When performing cascade connection for this device” (➔ page 26).

Note

- A web browser is required to use the web control function and the browser remote control. Confirm beforehand that the web browser can be used.

OS	Supported browser
Windows	Internet Explorer 8.0/9.0/10.0/11.0
Mac OS	Safari 6.0/7.0/8.0

- Illustration of the computer screen

The description in this document is using “Windows 7” as the OS, and “Internet Explorer 8.0” as the browser. The size or display of the screen may differ depending on the OS, browser, or the type of the computer in use.

Connection example

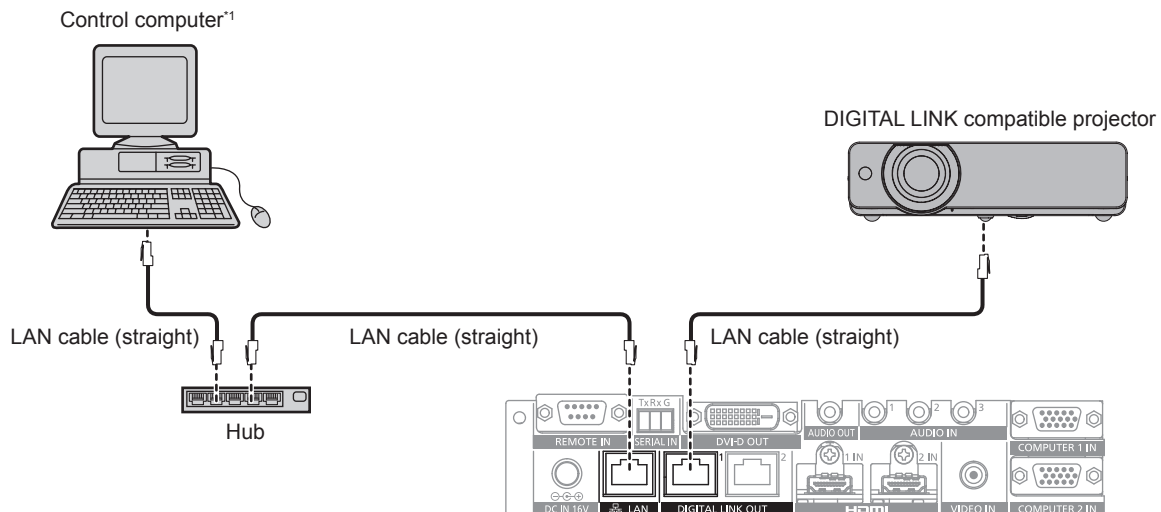

*1 Controls this device and the display (projector or flat panel display).

Attention

- Wire the LAN cable, which is directly connected to this device, only indoors.
- Do not use a hub to connect this device with the DIGITAL LINK compatible display (projector or flat panel display).
- Ask a qualified technician or your dealer for wiring work of the cable for DIGITAL LINK. The image or audio may be interrupted or disrupted by not achieving the cable transmission characteristics due to defective work.
- Use the cable conforming to following conditions as the LAN cable between this device and the DIGITAL LINK compatible display (projector or flat panel display).
 - Conforming to the CAT5e or a higher standard
 - Shielded type (including connectors)
 - Straight wire
 - Single wire

- Confirm that the cable specification satisfies the characteristics of CAT5e or higher by using a cable tester or a cable analyzer when laying the cable.
When a relay connector is used, include it in the measurement.
- To reduce the effect of a noise, install and use the cable between this device and the DIGITAL LINK compatible display (projector or flat panel display) unwound and stretched out.
- Do not pull the cable with excessive force. Also, do not bend or fold the cable forcefully.
- Do not bind with other cables, especially the power cable, and keep as much distance from other parallelly set cables.
- When connecting with the DIGITAL LINK compatible display (projector or flat panel display), open the DIGITAL LINK status menu of these displays after the cable is laid out, and confirm that the signal quality is -12 dB or less.

Note

- Maximum transferable distance is normally 100 m (328'1"). If the display (projector or flat panel display) to be connected is supporting the long reach communication method, it can transfer up to 150 m (492'1"). If the distance exceeds this, image or audio may be interrupted or error may occur in the LAN communication. Note that the usage exceeding the maximum transferable distance is not covered by the Panasonic support. Depending on the display to be connected, there may be limit in the signal or the distance that the display can receive. For details, refer to the Operating Instructions of the display in use.

Setting of the device

- 1) **Connect the device with a computer via LAN cable.**
- 2) **Turn on the power of the device.**
- 3) **Press the <MENU> button to open the [NETWORK] menu, and perform the [NETWORK SETUP] setting.**
 - For details, refer to "Setting [NETWORK SETUP]" (➡ page 60).

Note

- To connect to an existing network, confirm with the network administrator first.
- The factory default setting is as follows:

[DHCP]	OFF
[IP ADDRESS]	192.168.0.10
[SUBNET MASK]	255.255.255.0
[DEFAULT GATEWAY]	192.168.0.1
[DNS1]/[DNS2]	None

Setting of the computer

- 1) **Turn on the power of the computer.**
- 2) **Follow the instruction of the network administrator to perform the network setting.**
 - If this device is in the factory setting condition, it can be used as is when the network settings on the computer are set as follows.

[IP ADDRESS]	192.168.0.101
[SUBNET MASK]	255.255.255.0
[DEFAULT GATEWAY]	192.168.0.1

Note

- To connect the DIGITAL LINK compatible displays (projector or flat panel display) to the <DIGITAL LINK OUT 1> terminal and the <DIGITAL LINK OUT 2> terminal of this device and control them, it is necessary to configure the network settings of the displays. For details, refer to the Operating Instructions of the display in use.

Using the web control function

Setting, adjustment, and status display of this device are possible by accessing this device from a computer.

Accessing from the web browser

- 1) Start up the web browser on the computer.
- 2) Enter the IP address set on this device in the URL entry field of the web browser.
- 3) Enter the user name and the password.
 - The factory default setting is as follows: User name: user1 (user rights)/admin1 (administrator rights), password: panasonic (lower case)

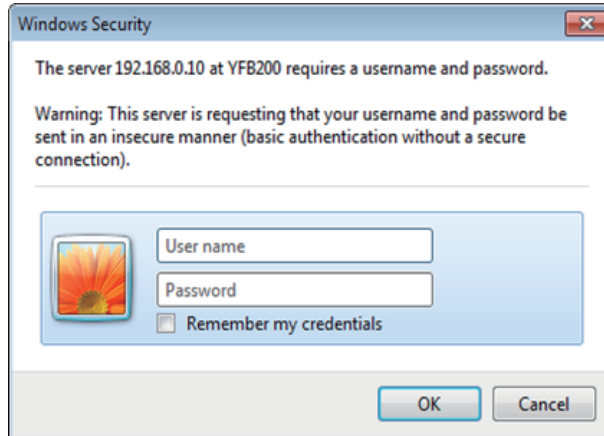

- 4) Click OK.
 - The [Switcher status] screen is displayed.



Note

- To use the web control function, go to the [OPTION] menu of the device → [NETWORK] (➔ page 60) → [NETWORK CONTROL] and set [WEB CONTROL] to [ON].
- Avoid performing setting or adjustment simultaneously by starting up multiple web browsers. Also, avoid performing setting or adjustment on a single DIGITAL LINK Switcher from multiple computers.
- Change the password first. (➔ page 71)
- The administrator rights allow use of all functions. With user rights, only the following functions can be used: [Switcher status] (➔ page 67), [Network status] (➔ page 68), [Access error] (➔ page 68), [Switcher control] (➔ page 69), and [Change password] (➔ page 71)
- Access will be locked for few minutes when an incorrect password is entered three times consecutively.
- Some items in the setting page of the web control use the Javascript function of the web browser. It may not be able to control correctly when the web browser is set not to use this function.
- If the screen for the web control is not displayed, consult your network administrator.
- While updating the screen for the web control, the screen may appear white for a moment, but it is not a malfunction.

Description of items

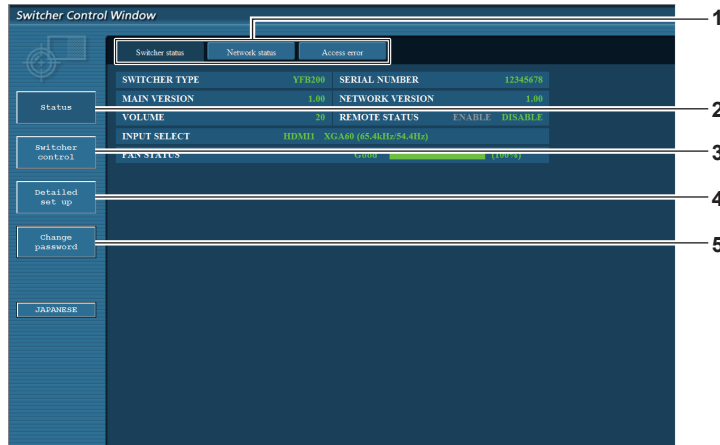

- 1 **Page tab**
Click this item to switch pages.
- 2 **[Status]**
Click this item to display the status of this device.
- 3 **[Switcher control]**
Click this item to display the [Switcher control] page.
- 4 **[Detailed set up]**
Click this item to display the [Detailed set up] page.
- 5 **[Change password]**
Click this item to display the [Change password] page.

[Switcher status] page

Click [Status] → [Switcher status].
Display the status of this device for following items.

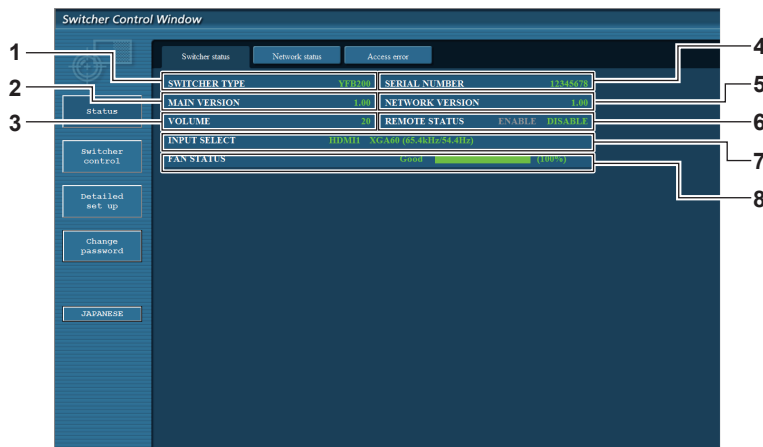

- 1 **[SWITCHER TYPE]**
Displays the type of the DIGITAL LINK Switcher.
- 2 **[MAIN VERSION]**
Displays the firmware version of the DIGITAL LINK Switcher.
- 3 **[VOLUME]**
Displays the status of the volume.
- 4 **[SERIAL NUMBER]**
Displays the serial number of the DIGITAL LINK Switcher.
- 5 **[NETWORK VERSION]**
Displays the firmware version of the network.
- 6 **[REMOTE STATUS]**
Displays the control status by the <REMOTE IN> terminal.
- 7 **[INPUT SELECT]**
Displays the status of the selected input.
- 8 **[FAN STATUS]**
Indicates the condition of the fan by [Good] (green), [Notice] (orange), or [Service] (red). Also, indicates the actual rotation of the fan against the target rotation by the value in percent and a bar scale.
Consult your dealer when [Notice] or [Service] is displayed.

[Network status] page

Click [Status] → [Network status].

Display the current network setting information.

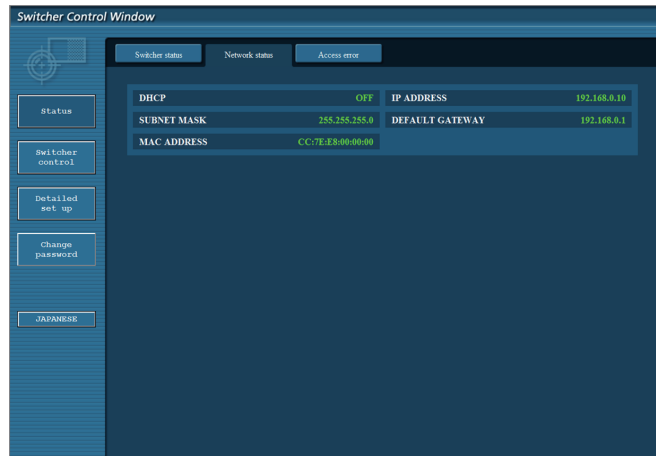

[Access error] page

Click [Status] → [Access error].

Error information of the Web server, such as access to a page that does not exist or access with illegal user name or illegal password, is displayed.

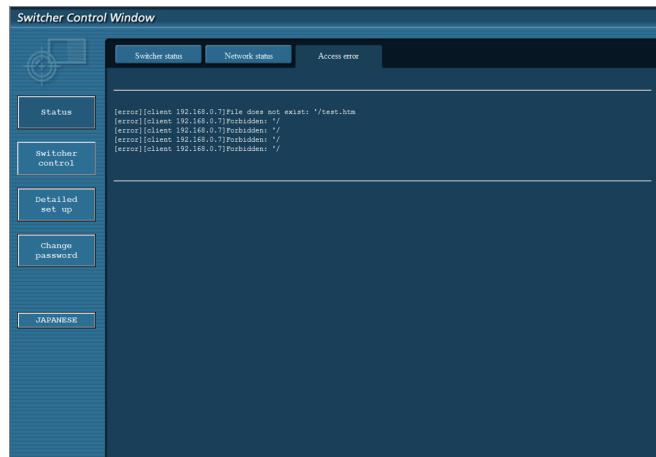

Note

- Past 16 access/request error information are displayed in the [Access error] page. Part of the error information may not display when 17 or more access/request errors have occurred at once.
- [Access error] will delete from the old information when the number of error information exceeds 16.
- Check [Access error] periodically.

[Switcher control] page

Click [Switcher control].

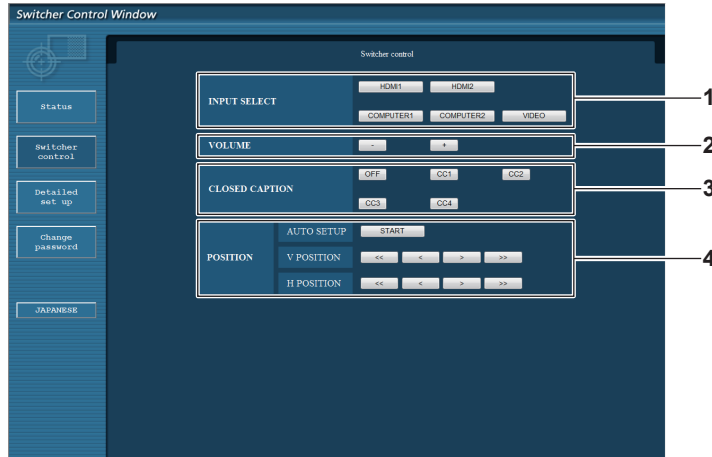

- | | |
|--|---|
| <p>1 [INPUT SELECT]
Switches the input signal.</p> <p>2 [VOLUME]
Adjusts the volume output from the <AUDIO OUT> terminal.
When the [OPTION] menu of the device → [AUDIO SETTING]
→ [AUDIO OUT SELECT] is set to [OFF] or [DIGITAL LINK],
[VOLUME] will not change. (▶ page 56)</p> | <p>3 [CLOSED CAPTION]
Switches the setting for the closed caption.</p> <p>4 [POSITION]
Operates the items regarding the angle of image.</p> |
|--|---|

[Network config] page

Click [Detailed set up] → [Network config].

- Click [Network config] to display the **[CAUTION!]** screen. Operate following the content of the message.
- Click the [Next] button to display current settings.
- Click the [Change] button to display the setting change screen.

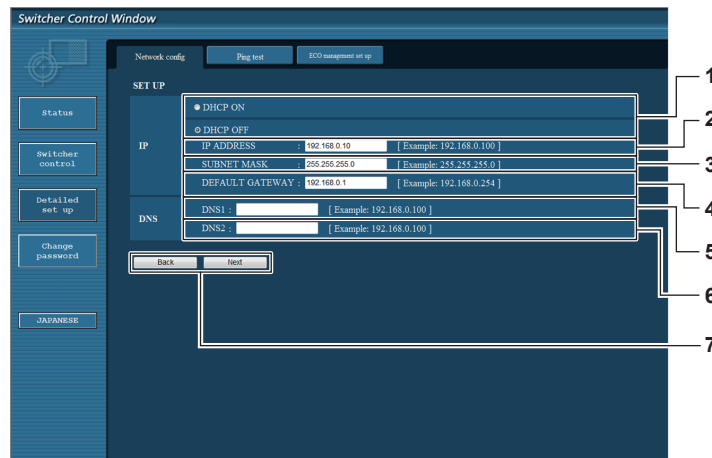

- | | |
|---|---|
| <p>1 [DHCP ON], [DHCP OFF]
To enable the DHCP client function, select [DHCP ON].</p> <p>2 [IP ADDRESS]
Enter the IP address when a DHCP server is not used.</p> <p>3 [SUBNET MASK]
Enter the subnet mask when a DHCP server is not used.</p> <p>4 [DEFAULT GATEWAY]
Enter the default gateway address when a DHCP server is not used.</p> <p>5 [DNS1]
Enter the DNS1 server address.
Characters that can be used to enter the DNS1 server address (primary):
Numbers (0 to 9), period (.)
(Ex.: 192.168.0.253)</p> | <p>6 [DNS2]
Enter the DNS2 server address.
Characters that can be used to enter the DNS2 server address (secondary):
Numbers (0 to 9), period (.)
(Ex.: 192.168.0.254)</p> <p>7 [Back], [Next]
Click the [Back] button to return to previous screen. Click the [Next] button to display the screen to confirm the current setting. Click the [Submit] button to update the setting.</p> |
|---|---|

Note

- The warning screen "Web page has expired" may be displayed when "back" or "next" function of the browser is used. In such a case,

subsequent operation is not guaranteed, so click [Network config] again.

- The communication may be disconnected when the LAN setting is changed while connected with the LAN.

[Ping test] page

Confirm that the network is connected with the DNS server, etc.

Click [Detailed set up] → [Ping test].

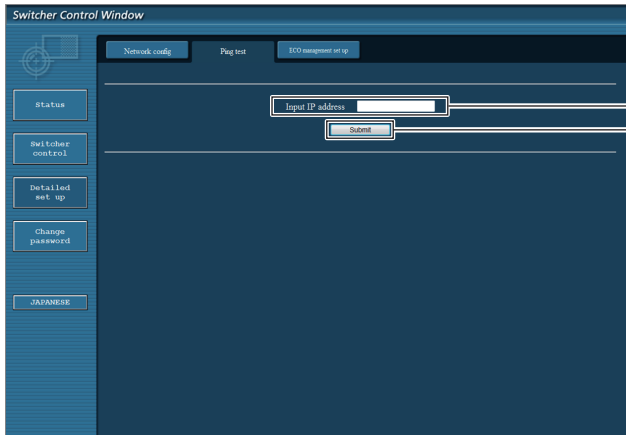

```
PING 192.168.0.10 (192.168.0.10): 56 data bytes
64 bytes from 192.168.0.10: seq=0 ttl=128 time=1 ms
64 bytes from 192.168.0.10: seq=1 ttl=128 time=1 ms
64 bytes from 192.168.0.10: seq=2 ttl=128 time=1 ms
64 bytes from 192.168.0.10: seq=3 ttl=128 time=1 ms

--- 192.168.0.10 ping statistics ---
4 packets transmitted, 4 packets received, 0% packet loss
round-trip min/avg/max = 1/1/1 ms
```

```
PING 192.168.0.8 (192.168.0.8): 56 data bytes

--- 192.168.0.8 ping statistics ---
4 packets transmitted, 0 packets received, 100% packet loss
```

- | | |
|--|---|
| <p>1 [Input IP address]
Enter the IP address of the server to test.</p> <p>2 [Submit]
Execute the connection test.</p> | <p>3 Display example of being able to connect</p> <p>4 Display example of not being able to connect</p> |
|--|---|

[ECO management set up] page

Set the [NO SIGNAL SLEEP] function for the DIGITAL LINK Switcher.

Click [Detailed set up] → [ECO management set up].

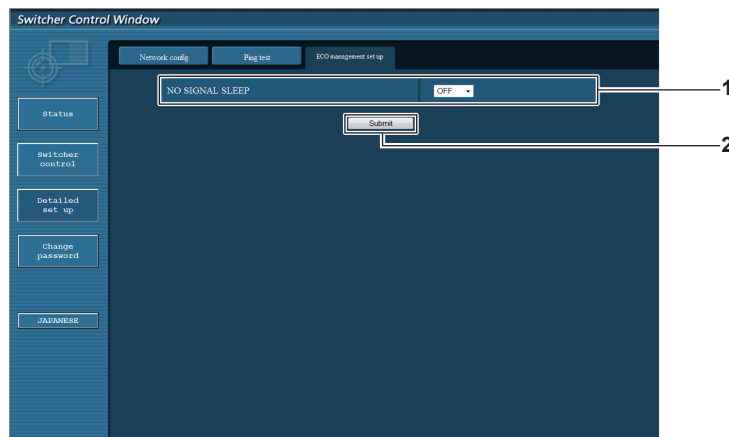

- | | |
|---|---|
| <p>1 [NO SIGNAL SLEEP]
Select the [NO SIGNAL SLEEP] setting.</p> | <p>2 [Submit]
Updates the setting.</p> |
|---|---|

Note

- For details for each setting item, refer to the [OPTION] menu of the DIGITAL LINK Switcher → [NO SIGNAL SLEEP] (➡ page 55).

[Change password] page

Click [Change password].

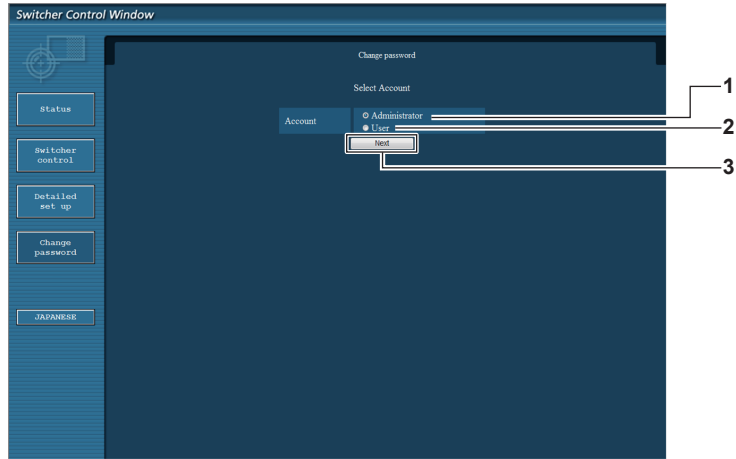

- | | |
|---|--|
| <p>1 [Administrator]
Select to change the setting of [Administrator].</p> <p>2 [User]
Select to change the setting of [User].</p> | <p>3 [Next]
Displays the screen to change the password setting.</p> |
|---|--|

[Administrator]

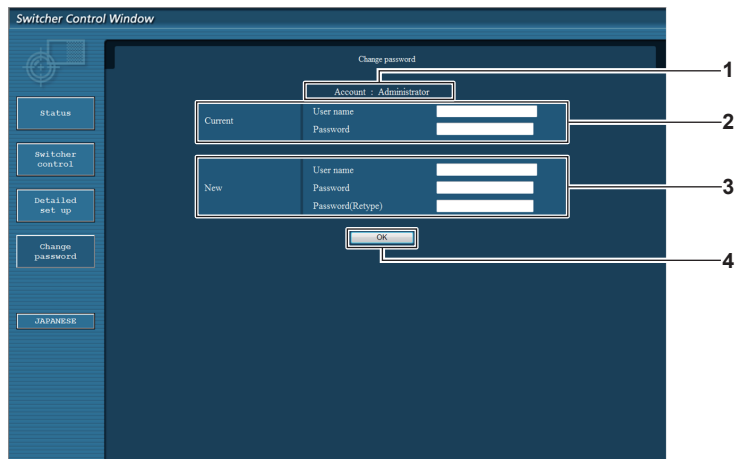

- | | |
|---|--|
| <p>1 [Account]
Displays the account to change.</p> <p>2 [Current]
[User name]:
Enter the user name before change.
[Password]:
Enter the password before change.</p> | <p>3 [New]
[User name]:
Enter a new user name. (Up to 16 characters in single byte)
[Password]:
Enter a new password. (Up to 16 characters in single byte)
[Password(Retype)]:
Enter the new password again.</p> <p>4 [OK]
Determines the change of password.</p> |
|---|--|

[User]

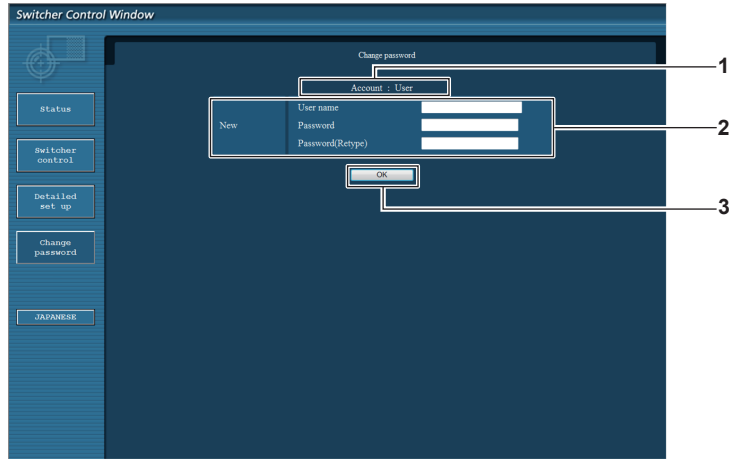

- | | |
|--|---|
| <p>1 [Account]
Displays the account to change.</p> <p>2 [New]
[User name]:
Enter a new user name. (Up to 16 characters in single byte)
[Password]:
Enter a new password. (Up to 16 characters in single byte)
[Password(Retype)]:
Enter the new password again.</p> | <p>3 [OK]
Determines the change of password.</p> |
|--|---|

[Change password] (For user rights)

Only the password change is enabled with the user rights.

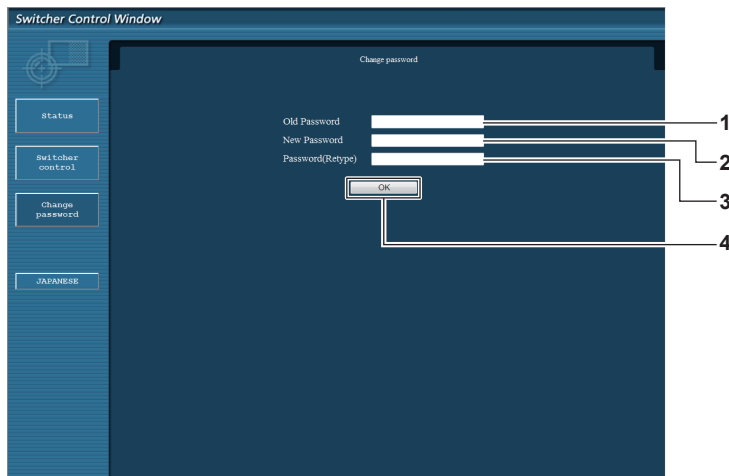

- | | |
|--|--|
| <p>1 [Old Password]
Enter the current password.</p> <p>2 [New Password]
Enter a new password. (Up to 16 characters in single byte)</p> | <p>3 [Password(Retype)]
Enter the new password again.</p> <p>4 [OK]
Determines the change of password.</p> |
|--|--|

Note

- To change the account of the administrator, you must enter the [User name] and [Password] in [Current].

Using the browser remote control

This device can be operated with the operation panel displayed on the web browser.

To use the browser remote control, use a computer with screen resolution of XGA (1 024 x 768) or higher.

Displaying the browser remote control

- 1) **Start up the web browser on the computer.**
- 2) **Enter “http://xxx.xxx.xxx.xxx/remote.htm” in the URL entry field of the web browser.**
 - xxx.xxx.xxx.xxx is the IP address set for this device.
- 3) **Enter the user name and the password for the web control.**
 - The factory default setting is as follows: User name: user1 (user rights)/admin1 (administrator rights), password: panasonic (lower case characters)



- 4) **Click OK.**
 - The browser remote control screen (operation panel) is displayed.



Note

- To use the browser remote control, go the [OPTION] menu of the device → [NETWORK] (➔ page 60) and set [WEB CONTROL] to [ON].
- Avoid starting up multiple browser remote controls and performing operations simultaneously. Also, avoid performing operations on a single DIGITAL LINK Switcher from multiple computers.
- Change the password first. (➔ page 71)
- The operation that can be performed is same for the administrator rights and user rights.
- Access will be locked for few minutes when an incorrect password is entered three times consecutively.
- Some items on the browser remote control screen use the Javascript function of the web browser. It may not be able to control correctly when the web browser is set not to use this function.
- If the browser remote control screen is not displayed, consult your network administrator.
- While updating the web control screen, the screen may appear white for a moment, but it is not a malfunction.
- Do not perform the operation on the device when operating the browser remote control.
- Do not perform the operation from the web control screen when operating the browser remote control.
- The screen display may become abnormal when “back” or “next” function of the web browser is used. In such a case, subsequent operation is not guaranteed, so update the web browser to the latest status.

Description of items

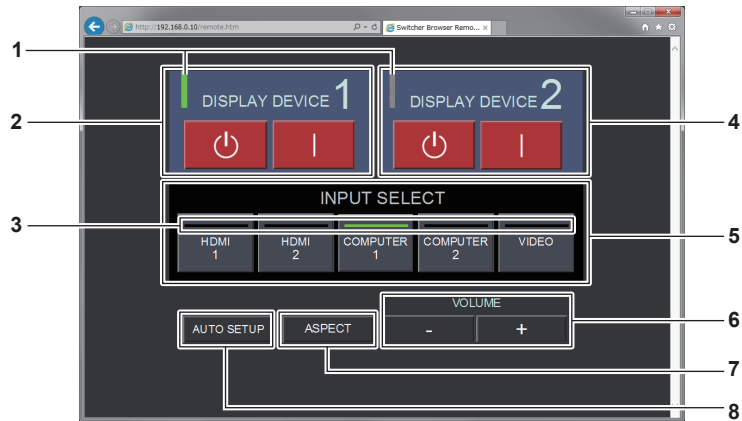

1 Display device indicator

Displays the status of the power of the display (projector or flat panel display) connected to the <DIGITAL LINK OUT 1> terminal/<DIGITAL LINK OUT 2> terminal. It is displayed in green when the power of the display is turned on. It is displayed in gray when the display is in standby mode or when a display is not connected.

2 [DISPLAY DEVICE 1]

Turns off/on the power of the display (projector or flat panel display) connected to the <DIGITAL LINK OUT 1> terminal.

3 Input terminal indicator

Displays the selected input in green.

4 [DISPLAY DEVICE 2]

Turns off/on the power of the display (projector or flat panel display) connected to the <DIGITAL LINK OUT 2> terminal.

5 [INPUT SELECT]

Switches the input signal. Status of the select/deselect can be confirmed at the indicator. Selected input is displayed in green at the indicator.

6 [VOLUME]

Adjusts the volume output from the <AUDIO OUT> terminal. Volume will increase by clicking [+], and volume will decrease by clicking [-]. When the [OPTION] menu of this device → [AUDIO SETTING] → [AUDIO OUT SELECT] is set to [OFF] or [DIGITAL LINK], [VOLUME] will not change. (➔ page 56)

7 [ASPECT]

Switches the aspect ratio of the image.

8 [AUTO SETUP]

Adjusts the screen display position automatically when the image is input.

Note

- The display of the display device indicator/input terminal indicator of the browser remote control may be slower to reflect the status than the on/off timing of the display device indicator/input terminal indicator on the control panel.

Chapter 6 Appendix

This chapter describes specifications and after-sales service for the device.

Maintenance

The air intake ports and the air exhaust ports at the top and sides of the device may get clogged with dirt or dust after long period of usage. Clean the air intake ports/air exhaust ports periodically.

Before maintenance

- Always turn off the power before maintenance.

Maintenance

Wipe off dirt and dust on the outer case with a soft, dry cloth.

- When removing dirt and dust, do not drop them inside the device.
- If the dirt is persistent, soak the cloth with water and wring it thoroughly before wiping. Dry off the device with a dry cloth.
- Do not use benzene, thinner, solvent such as alcohol, or kitchen detergent for cleaning. When these materials are used for cleaning, ripping of the paint or discoloration may occur.
- When using chemically treated dust cloths, follow the instructions written on its packaging.

Troubleshooting

Review the following points. For details, see the corresponding pages.

Problems	Points to be checked	Page
Power of the device does not turn on.	<ul style="list-style-type: none"> Is the power plug firmly inserted into the outlet? Is the power connector firmly inserted into the AC adapter? Is the AC adapter plug firmly inserted into the device? Is the outlet supplying electricity? Have the circuit breakers tripped? 	— — — — —
Image is not output.	• Are the video (output) device and the display (projector or flat panel display) correctly connected?	22
	• Is the input of the display (projector or flat panel display) set to DIGITAL LINK?	34
	• Is the input selection setting correct?	35
	• Is the external device that is connected to the device working properly?	—
	• Isn't the contact control enabled?	87
	• If the power indicator <POWER> or the input terminal indicator is blinking, consult your dealer.	—
Color is pale or grayish.	• Is the display (projector or flat panel display) connected to the device adjusted correctly?	22
Sound is not output.	• Are the <AUDIO IN 1> terminal/<AUDIO IN 2> terminal/<AUDIO IN 3> terminal correctly connected?	18
	• Isn't the sound volume set at a minimum?	55
	• Check the settings of [AUDIO OUT SELECT] and [AUDIO IN SELECT] in [AUDIO SETTING].	56
Remote control does not respond.	• Is the DIGITAL LINK compatible display (projector or flat panel display) connected to the <DIGITAL LINK OUT 1> terminal or the <DIGITAL LINK OUT 2> terminal?	24
	• When DIGITAL LINK compatible displays are connected to both <DIGITAL LINK OUT 1> terminal and <DIGITAL LINK OUT 2> terminal of the device, operation of the device is possible only with the remote control of the display connected to the <DIGITAL LINK OUT 1> terminal.	35
Buttons on the control panel do not operate.	• Isn't the contact control enabled?	87
Image does not display correctly.	• Is [SYSTEM SELECTOR] set correctly?	42
	• Is there a problem with the video tape or other image sources?	—
	• Is a signal which is not compatible with this device being input?	88
Image from a computer does not appear.	• Is the cable too long? (The D-Sub cable and the HDMI cable should be 10 m (32'10") or shorter.)	—
	• Is the external video output of the laptop computer set correctly? (Ex.: When the "Fn" + "F3" keys are pressed simultaneously, the external output setting may be switched. Since the method varies depending on the computer type, refer to the user manual provided with your computer.)	—
Image from the HDMI compatible device does not appear or it appears jumbled.	• Is the HDMI cable connected securely?	23
	• Turn the power of the device and the external device off and on.	—
	• Is a signal which is not compatible with this device being input?	88
	• Is the video display device compliant to HDCP used?	—
Audio of the HDMI compatible device is not output.	• Set the audio of the external device to the linear PCM.	—
	• Check [AUDIO IN SELECT] in [AUDIO SETTING].	56
	• If the audio is not output with HDMI cable connection, use the <AUDIO IN 1> terminal/<AUDIO IN 2> terminal/<AUDIO IN 3> terminal.	18

Attention

- If problems persist even after checking the preceding points, consult your dealer.

Frequently Asked Questions

Check the following.

Video is not displayed across the entire screen when HDMI signals are input from a computer.

Perform the following two steps.

- Adjust the aspect ratio of screens output by a computer to suit pixels (aspect ratio) of the display (projector or flat panel display). (Ex.: When the pixels of the display are 1 024 x 768 dots (4:3), set the resolution of the screen on the computer to 800 x 600 dots (4:3).)
- Set [ASPECT] to [FULL]. (➔ page 45)

Technical information

PJLink protocol

The network function of the device supports PJLink Class 1, and PJLink protocol can be used to perform setting of this device and the display (projector or flat panel display) and status query from a computer.

Connection

■ When connecting to the DIGITAL LINK compatible display

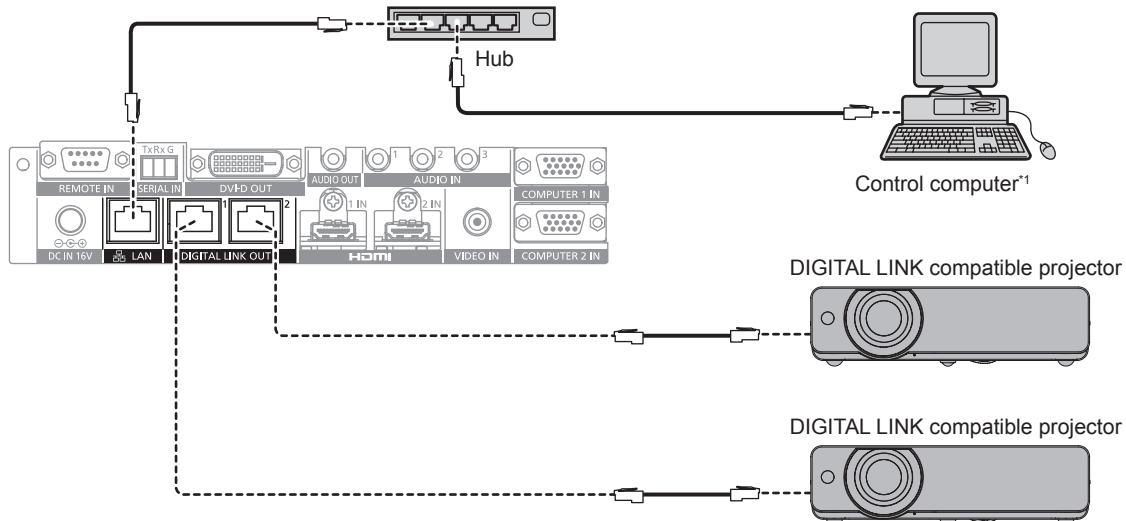

*1 Controls the display (projector or flat panel display).

■ When connecting to non-DIGITAL LINK compatible display

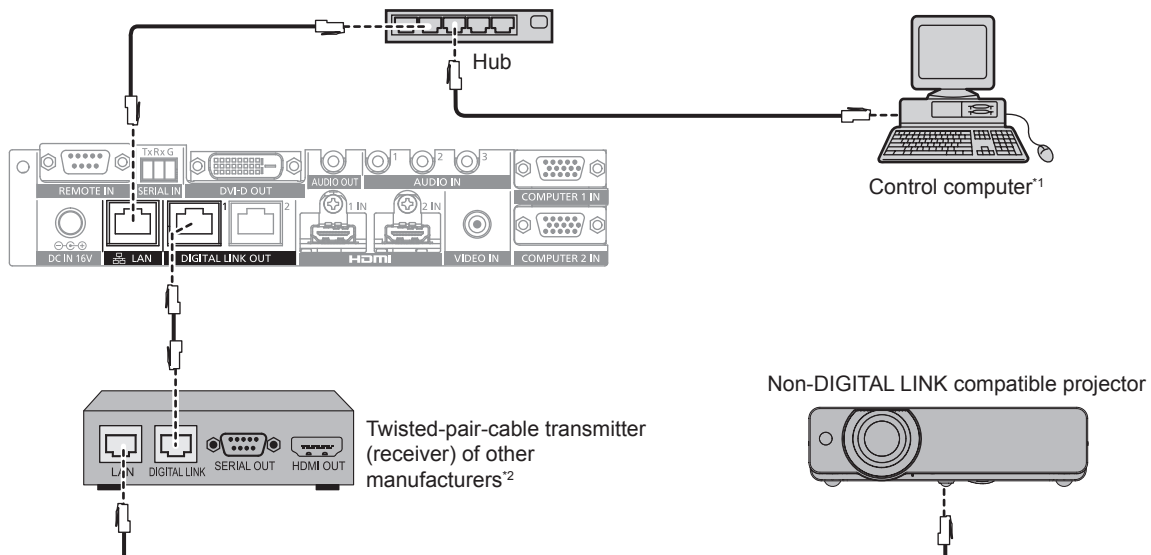

*1 Controls the display (projector or flat panel display).

*2 Name of the DIGITAL LINK terminal may differ depending on the manufacturer.

Control commands

These are the commands used to control this device with the PJLink protocol.

- The x in the table is arbitrary character.

Command	Control	Parameter/return string	Remarks
INPT	Input selection	11 12	COMPUTER 1 COMPUTER 2
INPT?	Input selection query	21 31 32	VIDEO HDMI 1 HDMI 2
INST?	Input selection list query	11 12 21 31 32	
INF1?	Manufacturer name query	Panasonic	Returns manufacturer name.
INF2?	Model name query	YFB200G	Returns model name.
INF0?	Other information queries	xxxxx	Returns information such as version number.
CLSS?	Class information query	1	Returns the PJLink class.
ERST?	Fan status query	000000 200000	Good Notice or Service

PJLink security authentication

The password used for the PJLink is the same as the password set in the web control.

To use without authentication, set the web control password to none.

- For specification regarding the PJLink, visit the Japan Business Machine and Information System Industries Association website.

URL <http://pjlink.jbmia.or.jp/english/>

Control commands via LAN

When web control administrator rights password is set (Protect mode)

Connecting

- 1) Obtain the IP address and port number (Initial set value = 1024) of the display (projector or flat panel display) and request a connection to the display.
 - You can obtain both the IP address and the port number from the menu screen of the display main body.

IP address	Obtain from the [OPTION] menu → [NETWORK] → [NETWORK STATUS]
Port number	Obtain from the [OPTION] menu → [NETWORK] → [NETWORK CONTROL] → [COMMAND PORT]

- 2) Check the response from the display.

	Data section	Blank	Mode	Blank	Random number section	Termination symbol
Command example	"NTCONTROL" (ASCII string)	' '	'1'	' '	"zzzzzzzz" (ASCII code hexadecimal)	(CR) 0x0d
Data length	9 bytes	1 byte	1 byte	1 byte	8 bytes	1 byte

- Mode: 1 = Protect mode
- Example: Response during protect mode (random number section is undefined value)
"NTCONTROL 1 23181e1e" (CR)

- 3) Generate a 32-byte hash value from the following data using MD5 algorithm.

- "xxxxxx:yyyyy:zzzzzzzz"

xxxxxx	Administrator rights user name for the web control (default user name is "admin1")
yyyyy	Password of above administrator rights user (default password is "panasonic")
zzzzzzzz	8-byte random number obtained in Step 2)

Command transmission method

Transmit using the following command formats.

■ **Transmitted data**

	Header			Data section	Termination symbol
Command example	Hash value "Connecting" (➔ page 80)	'0' 0x30	'0' 0x30	Control command (ASCII string)	(CR) 0x0d
Data length	32 bytes	1 byte	1 byte	Undefined length	1 byte

- Example: Transmission of power supply status acquisition command (hash value is calculated from default user name, password, and acquired random number)
"dbdd2dabd3d4d68c5dd970ec0c29fa6400QPW" (CR)

■ **Received data**

	Header		Data section	Termination symbol
Command example	'0' 0x30	'0' 0x30	Control command (ASCII string)	(CR) 0x0d
Data length	1 byte	1 byte	Undefined length	1 byte

- Example: The power of the device is turned on
"00001" (CR)

■ **Error response**

	String	Details	Termination symbol
Message	"ERR1"	Undefined control command	(CR) 0x0d
	"ERR2"	Out of parameter range	
	"ERR3"	Busy state or no-acceptable period	
	"ERR4"	Timeout or no-acceptable period	
	"ERR5"	Wrong data length	
	"ERRA"	Password mismatch	
Data length	4 bytes	—	1 byte

When web control administrator rights password is not set (Non-protect mode)

Connecting

- 1) **Obtain the IP address and port number (Initial set value = 1024) of the display (projector or flat panel display) and request a connection to the display.**
 - You can obtain both the IP address and the port number from the menu screen of the display main body.

IP address	Obtain from the [OPTION] menu → [NETWORK] → [NETWORK STATUS]
Port number	Obtain from the [OPTION] menu → [NETWORK] → [NETWORK CONTROL] → [COMMAND PORT]

- 2) **Check the response from the display.**

	Data section	Blank	Mode	Termination symbol
Command example	"NTCONTROL" (ASCII string)	' ' 0x20	'0' 0x30	(CR) 0x0d
Data length	9 bytes	1 byte	1 byte	1 byte

- Mode: 0 = Non-protect mode
- Example: Response during non-protect mode
"NTCONTROL 0" (CR)

Command transmission method

Transmit using the following command formats.

■ **Transmitted data**

	Header		Data section	Termination symbol
Command example	'0' 0x30	'0' 0x30	Control command (ASCII string)	(CR) 0x0d
Data length	1 byte	1 byte	Undefined length	1 byte

- Example: Transmission of power supply status acquisition command
"00QPW" (CR)

■ **Received data**

	Header		Data section	Termination symbol
Command example	'0' 0x30	'0' 0x30	Control command (ASCII string)	(CR) 0x0d
Data length	1 byte	1 byte	Undefined length	1 byte

- Example: The power of the device is in standby mode
"00000" (CR)

■ **Error response**

	String	Details	Termination symbol
Message	"ERR1"	Undefined control command	(CR) 0x0d
	"ERR2"	Out of parameter range	
	"ERR3"	Busy state or no-acceptable period	
	"ERR4"	Timeout or no-acceptable period	
	"ERR5"	Wrong data length	
	"ERRA"	Password mismatch	
Data length	4 bytes	—	1 byte

<SERIAL IN> terminal

The <SERIAL IN> terminal on this device is a terminal to externally control the device and the display (projector or flat panel display) connected via the <DIGITAL LINK OUT 1> terminal/<DIGITAL LINK OUT 2> terminal. This is used to be connected to the serial terminal (RS-232C compliant) of the control computer using the supplied Plug for 3-pin 3.5 mm detachable terminal block.

It is necessary for the customer to prepare the communication cable. For the specification, refer to “Cable specification” (➡ page 86).

Connection example

■ When connecting to the DIGITAL LINK compatible display

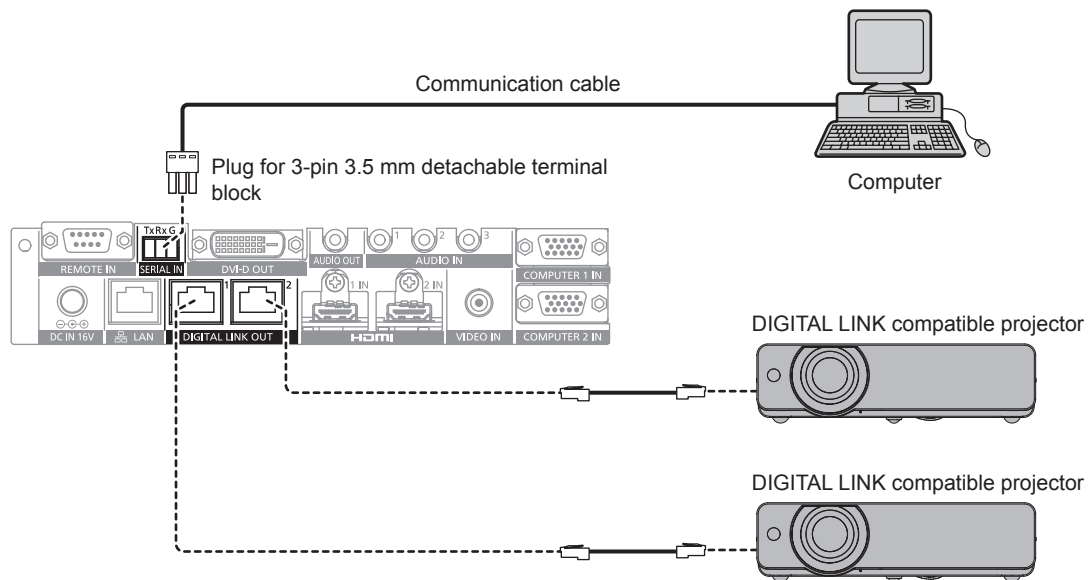

■ When connecting to non-DIGITAL LINK compatible display

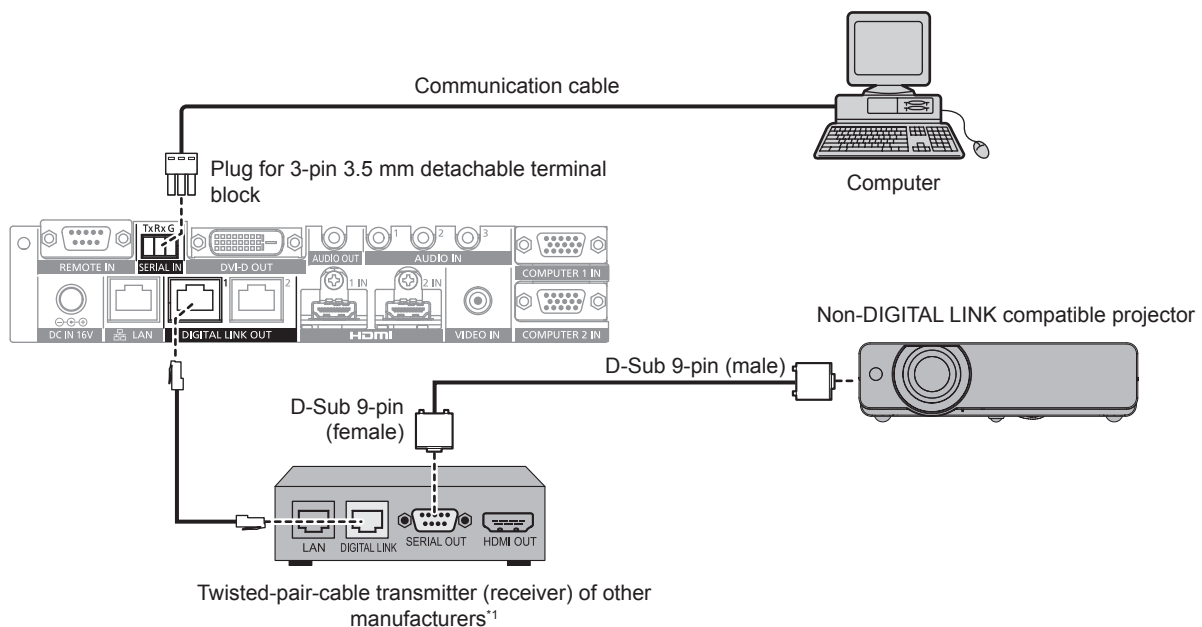

*1 Name of the DIGITAL LINK terminal may differ depending on the manufacturer.

Pin assignments and signal names

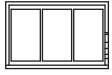
3-pin 3.5 mm removable terminal block Outside view	Pin No.	Signal name	Details
TxRxG  (1) → (3)	(1)	TXD	Transmitted data
	(2)	RXD	Received data
	(3)	GND	Earth

Communication conditions (Factory default)

Signal level	RS-232C-compliant
Sync. method	Asynchronous
Baud rate	9 600 bps
Parity	None
Character length	8 bits
Stop bit	1 bit
X parameter	None
S parameter	None

Basic format

Transmission from the computer starts with STX, then the ID, command, parameter, and ETX are sent in this order. Add parameters according to the details of control.

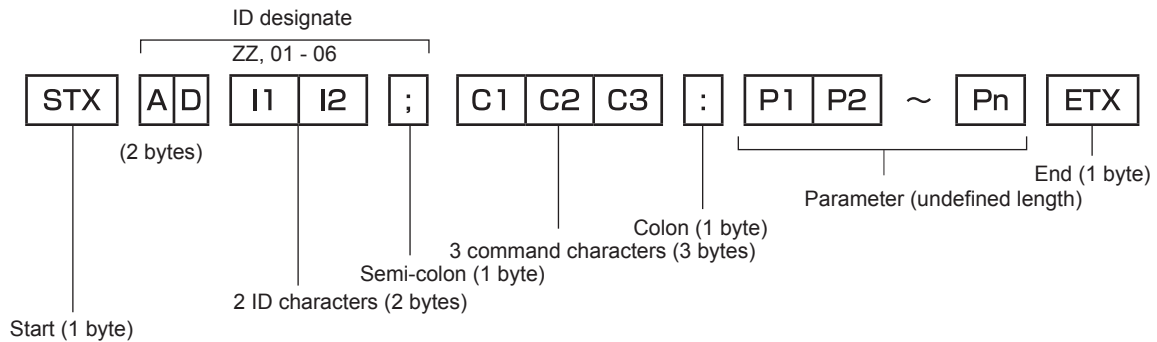

Basic format (has subcommands)

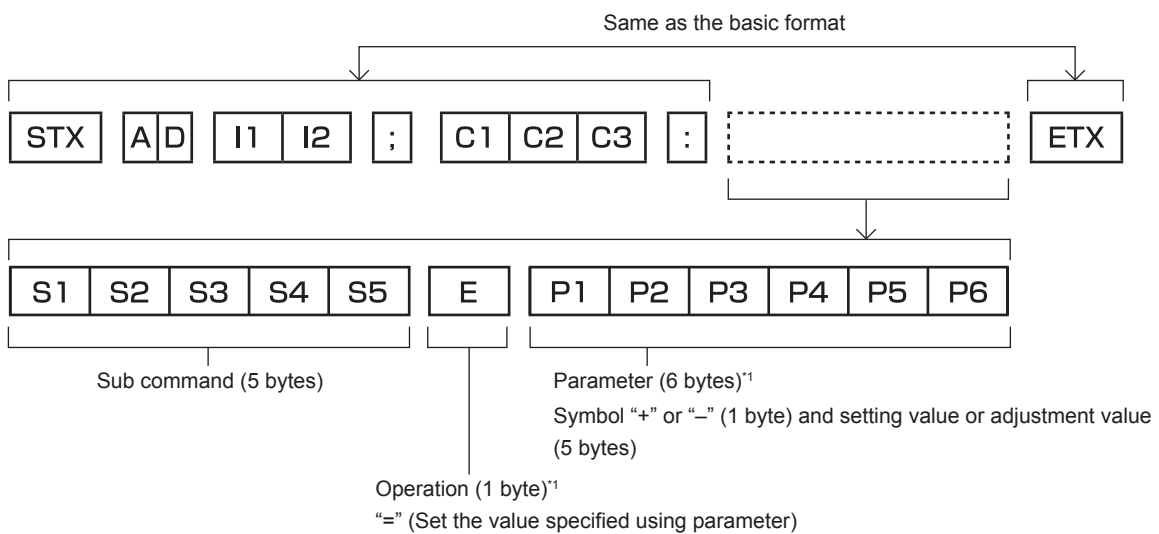

*1 When transmitting a command which does not need a parameter, an operation (E) and parameter are not necessary.

Attention

- The response may be delayed or command may not be executed when a command is transmitted right after the power of the device is turned on. Try sending or receiving any command after 30 seconds.
- When transmitting multiple commands, be sure to wait until 0.5 seconds has elapsed after receiving the response from the device before sending the next command. When transmitting a command which does not need a parameter, a colon (:) is not necessary.

Note

- If a command cannot be executed, the “ER401” response is sent from the device to the computer.
- If an invalid parameter is sent, the “ER402” response is sent from the device to the computer.
- ID transmission in RS-232C supports ZZ (ALL) and 01 to 06.
- If a command is sent with a specified ID, a response will be sent to the computer only in the following cases.
 - It matches the ID of the device
 - ID is designated as ALL and [RESPONSE(ID ALL)] is set to [ON]
 - ID is designated as GROUP and [RESPONSE(GROUP)] is set to [ON]
- Control of the device is performed only in the following cases when the command is sent with a specified ID.
 - It matches the ID of the device
 - ID is designated as ALL and [CONTROL(ID ALL)] is set to [ENABLE]
- STX and ETX are character codes. STX shown in hexadecimal is 02, and ETX shown in hexadecimal is 03.

Controlling multiple devices

Controlling all of the multiple devices

Perform following setting when multiple switchers and displays (projector or flat panel display) are to be controlled together by the RS-232C.

- 1) **Set different ID for each device.**
- 2) **Set [RESPONSE(ID ALL)] to [ON] in a single device only.**
- 3) **Set [RESPONSE(ID ALL)] to [OFF] for devices other than one set in Step 2).**

Controlling multiple devices in group unit

Perform following setting when multiple switchers and displays (projector or flat panel display) are controlled in a group unit with RS-232C.

- 1) **Set different ID for each device.**
- 2) **Set [RESPONSE(GROUP)] to [ON] in a single device only.**
- 3) **Set [RESPONSE(GROUP)] to [OFF] for devices other than one set in Step 2).**

Note

- The device cannot respond correctly when [RESPONSE(ID ALL)] is set to [ON] on two or more devices.
- The device cannot respond correctly when [RESPONSE(GROUP)] is set to [ON] on two or more devices in the same group.
- To set multiple groups, set [RESPONSE(ID ALL)] to [ON] only on a single device in each group.

Cable specification

Prepare a cable to connect the <SERIAL IN> terminal of this device and the serial terminal (RS-232C compliant) of the control computer using the supplied Plug for 3-pin 3.5 mm detachable terminal block.

Creation of a cable when the serial terminal of the computer is D-Sub 9-pin (male) is described here as an example. Purchase commercially available products for the D-Sub 9-pin (female) connector and lead wire necessary for the creation.

- Applicable wire for Plug for 3-pin 3.5 mm detachable terminal block: Diameter of the wire is AWG28 to AWG14.
- Use the lead wire with wire diameter that is applicable for both the Plug for 3-pin 3.5 mm detachable terminal block and the D-Sub 9-pin (female) connector (commercially available).

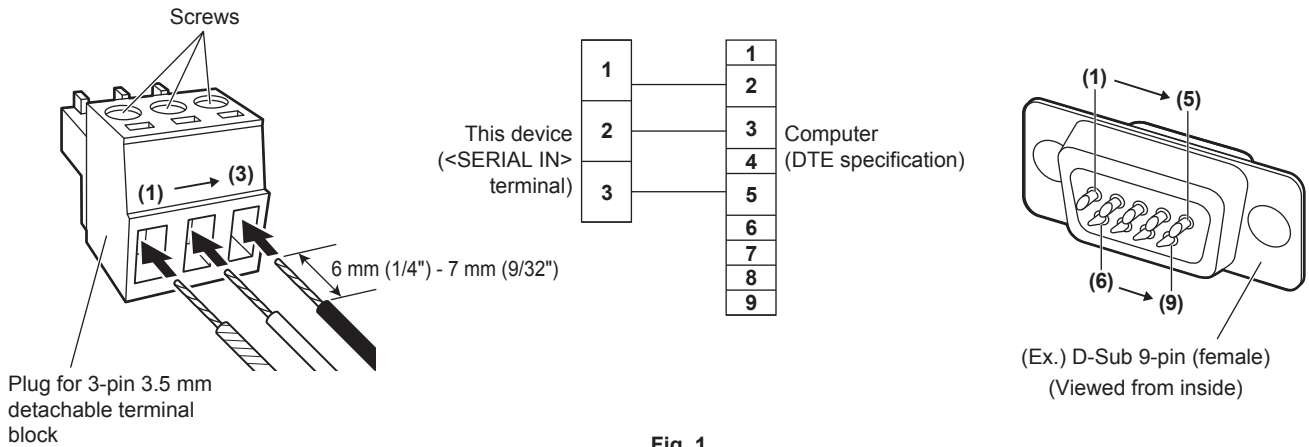

Fig. 1

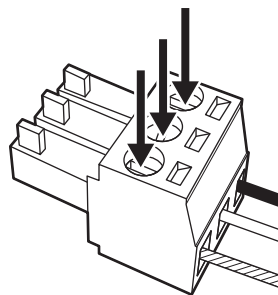

Fig. 2

- 1) Insert lead wires into the supplied Plug for 3-pin 3.5 mm detachable terminal block. (Fig. 1)**
 - Stripping length of the tip of lead wire: 6 mm (1/4") to 7 mm (9/32").
 - Loosen the screws of the Plug for 3-pin 3.5 mm detachable terminal block if it is difficult to insert the lead wire.
- 2) Tighten the screws of the Plug for 3-pin 3.5 mm detachable terminal block securely with a screwdriver and fix the lead wires. (Fig. 2)**
 - Applicable screwdriver: A flathead screwdriver with tip width of 2.5 mm (3/32") or less and tip thickness of 0.4 mm (1/32")
- 3) Connect the other side of the lead wire to the corresponding pin of the D-Sub 9-pin (female) connector (Fig. 1).**
 - Follow the method specified by the connector manufacturer for connecting to the D-Sub 9-pin (female) connector.

Control commands

These are the commands used to control this device with a computer.

Command	Control	Parameter/return string	Remarks
IIS	Input signal selection	VID	VIDEO
QIN	Input signal query	PC1	COMPUTER 1
		PC2	COMPUTER 2
		HD1	HDMI 1
		HD2	HDMI 2

Note

- For the control command of the display (projector or flat panel display) connected to this device, refer to the Operating Instruction of the display in use.

<REMOTE IN> terminal

By using the <REMOTE IN> terminal of the device, it is possible to remotely control (contact control) the device from the control panel installed in different location when the remote control signal cannot reach the display (projector or flat panel display).

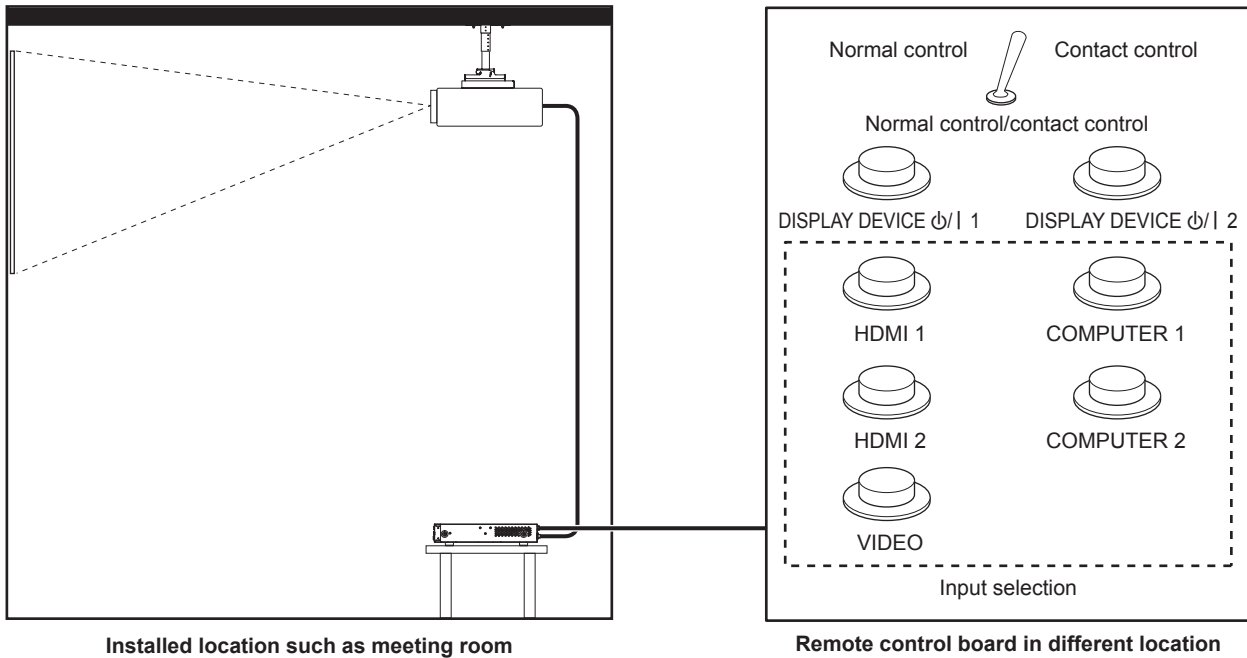

Pin assignments and signal names

D-Sub 9-pin Outside view	Pin No.	Signal name	Open (H)	Short (L)
	(1)	GND	—	GND
	(2)	DISPLAY DEVICE ϕ /1	STANDBY	POWER ON
	(3)	DISPLAY DEVICE ϕ /2	STANDBY	POWER ON
	(4)	HDMI 1	Other	HDMI 1
	(5)	HDMI 2	Other	HDMI 2
	(6)	COMPUTER 1	Other	COMPUTER 1
	(7)	COMPUTER 2	Other	COMPUTER 2
	(8)	VIDEO	Other	VIDEO
	(9)	Enable/disable	Normal control	External contact control

Attention

- When controlling, make sure to short-circuit pins (1) and (9).
 Following buttons on this device become disabled when pins (1) and (9) are short-circuited.
 RS-232C commands and network functions corresponding to these functions are also disabled.
 - <HDMI 1> button, <HDMI 2> button, <COMPUTER 1> button, <COMPUTER 2> button, <VIDEO> button
- Depending on the status of the connected display (projector or flat panel display), the power of the display may not be turned off/on with the operation from this device.

Compatible signals

List of compatible signals (input)

The following are the video signals supported by the input of this device.

• Symbols that indicate formats are as follows.

- V: VIDEO, Y/C
- R: RGB
- Y: YC_BC_R/YP_BP_R
- H: HDMI

Compatible signal	Resolution (Dots)	Scanning freq.		Dot clock freq. (MHz)	Format	Plug and play ^{*1}	
		Horizontal (kHz)	Vertical (Hz)			COMPUTER 1/ COMPUTER 2 ^{*2}	HDMI 1/HDMI 2 ^{*3}
NTSC/NTSC4.43/ PAL-M/PAL60	720 x 480i	15.7	59.9	—	V	—	—
PAL/PAL-N/SECAM	720 x 576i	15.6	50.0	—	V	—	—
525i (480i)	720 x 480i	15.7	59.9	13.5	R/Y	—	—
625i (576i)	720 x 576i	15.6	50.0	13.5	R/Y	—	—
525i (480i)	720 (1440) x 480i ^{*4}	15.7	59.9	27.0	H	—	—
625i (576i)	720 (1440) x 576i ^{*4}	15.6	50.0	27.0	H	—	—
525p (480p)	720 x 483	31.5	59.9	27.0	R/Y/H	—	✓
625p (576p)	720 x 576	31.3	50.0	27.0	R/Y/H	—	✓
750 (720)/60p	1 280 x 720	45.0	60.0	74.3	R/Y/H	—	✓
750 (720)/50p	1 280 x 720	37.5	50.0	74.3	R/Y/H	—	✓
1125 (1080)/60i ^{*5}	1 920 x 1 080i	33.8	60.0	74.3	R/Y/H	—	✓
1125 (1080)/50i	1 920 x 1 080i	28.1	50.0	74.3	R/Y/H	—	✓
1125 (1080)/24p	1 920 x 1 080	27.0	24.0	74.3	R/Y/H	—	✓
1125 (1080)/24sF ^{*6}	1 920 x 1 080i	27.0	48.0	74.3	R/Y/H	—	—
1125 (1080)/25p	1 920 x 1 080	28.1	25.0	74.3	R/Y/H	—	—
1125 (1080)/30p	1 920 x 1 080	33.8	30.0	74.3	R/Y/H	—	—
1125 (1080)/60p	1 920 x 1 080	67.5	60.0	148.5	R/Y/H	—	✓
1125 (1080)/50p	1 920 x 1 080	56.3	50.0	148.5	R/Y/H	—	✓
VESA400	640 x 400	31.5	70.1	25.2	R/H	—	—
	640 x 400	37.9	85.1	31.5	R/H	—	—
VGA480	640 x 480	31.5	59.9	25.2	R/H	✓	✓
	640 x 480	35.0	66.7	30.2	R/H	—	—
	640 x 480	37.9	72.8	31.5	R/H	✓	✓
	640 x 480	37.5	75.0	31.5	R/H	✓	✓
	640 x 480	43.3	85.0	36.0	R/H	—	—
SVGA	800 x 600	35.2	56.3	36.0	R/H	✓	✓
	800 x 600	37.9	60.3	40.0	R/H	✓	✓
	800 x 600	48.1	72.2	50.0	R/H	✓	✓
	800 x 600	46.9	75.0	49.5	R/H	✓	✓
	800 x 600	53.7	85.1	56.3	R/H	—	—
MAC16	832 x 624	49.7	74.6	57.3	R/H	✓	✓
XGA	1 024 x 768	39.6	50.0	51.9	R/H	—	—
	1 024 x 768	48.4	60.0	65.0	R/H	✓	✓
	1 024 x 768	56.5	70.1	75.0	R/H	✓	✓
	1 024 x 768	60.0	75.0	78.8	R/H	✓	✓
	1 024 x 768	65.5	81.6	86.0	R/H	—	—
	1 024 x 768	68.7	85.0	94.5	R/H	—	—
	1 024 x 768	81.4	100.0	113.3	R/H	—	—
	1 024 x 768	98.8	120.0	139.1	R/H	✓	✓
MXGA	1 152 x 864	53.7	60.0	81.6	R/H	—	—
	1 152 x 864	64.0	70.0	94.2	R/H	—	—
	1 152 x 864	67.5	74.9	108.0	R/H	—	—
	1 152 x 864	77.1	85.0	119.7	R/H	—	—

Chapter 6 Appendix — Technical information

Compatible signal	Resolution (Dots)	Scanning freq.		Dot clock freq. (MHz)	Format	Plug and play ^{*1}	
		Horizontal (kHz)	Vertical (Hz)			COMPUTER 1/ COMPUTER 2 ^{*2}	HDMI 1/HDMI 2 ^{*3}
MAC21	1 152 x 870	68.7	75.1	100.0	R/H	✓	✓
1280 x 720	1 280 x 720	37.1	49.8	60.5	R/H	—	—
	1 280 x 720	44.8	59.9	74.5	R/H	—	—
	1 280 x 720	76.3	100.0	131.8	R/H	—	—
	1 280 x 720	92.6	120.0	161.6	R/H	—	—
1280 x 768	1 280 x 768	39.6	49.9	65.3	R/H	—	—
	1 280 x 768	47.8	59.9	79.5	R/H	—	—
	1 280 x 768 ^{*7}	47.4	60.0	68.3	R/H	—	—
	1 280 x 768	60.3	74.9	102.3	R/H	—	—
1280 x 800	1 280 x 800	41.3	50.0	68.0	R/H	—	—
	1 280 x 800	49.7	59.8	83.5	R/H	—	—
MSXGA	1 280 x 960	60.0	60.0	108.0	R/H	—	—
SXGA	1 280 x 1 024	52.4	50.0	88.0	R/H	—	—
	1 280 x 1 024	64.0	60.0	108.0	R/H	✓	✓
	1 280 x 1 024	72.3	66.3	125.0	R/H	—	—
	1 280 x 1 024	78.2	72.0	135.1	R/H	—	—
	1 280 x 1 024	80.0	75.0	135.0	R/H	✓	✓
	1 280 x 1 024	91.1	85.0	157.5	R/H	—	—
1366 x 768	1 366 x 768	39.6	49.9	69.0	R/H	—	—
	1 366 x 768	47.7	59.8	85.5	R/H	—	—
SXGA+	1 400 x 1 050	54.1	50.0	99.9	R/H	—	—
	1 400 x 1 050	64.0	60.0	108.0	R/H	—	—
	1 400 x 1 050	65.2	60.0	122.6	R/H	—	—
	1 400 x 1 050	65.3	60.0	121.8	R/H	✓	✓
	1 400 x 1 050	78.8	72.0	149.3	R/H	—	—
	1 400 x 1 050	82.2	75.0	155.9	R/H	—	—
WXGA+	1 440 x 900	46.3	49.9	86.8	R/H	—	—
	1 440 x 900	55.9	59.9	106.5	R/H	—	—
1600 x 900	1 600 x 900	46.4	49.9	96.5	R/H	—	—
	1 600 x 900	55.9	60.0	119.0	R/H	✓	✓
UXGA	1 600 x 1 200	61.8	49.9	131.5	R/H	—	—
	1 600 x 1 200	75.0	60.0	162.0	R/H	✓	✓
WSXGA+	1 680 x 1 050	54.1	50.0	119.5	R/H	—	—
	1 680 x 1 050	65.3	60.0	146.3	R/H	—	—
1920 x 1080	1 920 x 1 080	55.6	49.9	141.5	R/H	—	—
	1 920 x 1 080 ^{*7}	66.6	59.9	138.5	R/H	—	—
	1 920 x 1 080 ^{*8}	67.2	60.0	173.0	R	—	—
WUXGA	1 920 x 1 200	61.8	49.9	158.3	R/H	—	—
	1 920 x 1 200 ^{*7}	74.0	60.0	154.0	R/H	✓	✓
	1 920 x 1 200 ^{*8}	74.6	59.9	193.3	R	—	—

*1 The signal with ✓ in the Plug and play column is a signal that is described in the EDID (extended display identification data) of this device and the display. Even if the signal does not have ✓ in the Plug and play column, it can be input if there is a description in the Format column. The signal without ✓ in the Plug and play column may not be able to select the resolution on the computer even if this device or the display is supporting the signal.

*2 This indicates that the plug and play is supported when the [OPTION] menu → [COMPUTER IN] → [COMPUTER 2 EDID MODE] is set to [DEFAULT]. When [COPY] or [USER] is set, it will follow the EDID for the setting.

*3 This indicates that the plug and play is supported when the [OPTION] menu → [HDMI IN] → [HDMI 2 EDID MODE] is set to [DEFAULT]. When [COPY] or [USER] is set, it will follow the EDID for the setting.

*4 Pixel-Repetition signal (dot clock frequency 27.0 MHz) only

*5 When 1125 (1035)/60i signal is input, it is displayed as 1125 (1080)/60i signal.

*6 Does not support the frame lock.

*7 VESA CVT-RB (Reduced Blanking) compliant

*8 The image is displayed by sampling the pixels with the image-processing circuit.

Note

- The “i” at the end of the resolution indicates an interlaced signal.
- When interlaced signals are connected, flickering may occur on the image.
- The image may not be displayed even for the compatible signal that is described if the video signal is recorded with a special format.

List of compatible signals (output)

The following are video signals supported by this device. The output resolution will differ depending on the input signal, frame lock setting, and output resolution setting.

- Symbol that indicates format is as follows. The compatible signals for the <DIGITAL LINK OUT 1> terminal/<DIGITAL LINK OUT 2> terminal and the <DVI-D OUT> terminal are the same.
 - D: DIGITAL LINK, DVI-D

Compatible signal	Resolution (dots)	Scanning freq.		Dot clock freq. (MHz)	Format
		Horizontal (kHz)	Vertical (Hz)		
750 (720)/60p	1 280 x 720	45.0	60.0	74.3	D
750 (720)/50p	1 280 x 720	37.5	50.0	74.3	D
1125 (1080)/24p	1 920 x 1 080	27.0	24.0	74.3	D
1125 (1080)/25p	1 920 x 1 080	28.1	25.0	74.3	D
1125 (1080)/30p	1 920 x 1 080	33.8	30.0	74.3	D
1125 (1080)/60p	1 920 x 1 080	67.5	60.0	148.5	D
1125 (1080)/50p	1 920 x 1 080	56.3	50.0	148.5	D
XGA	1 024 x 768	48.4	60.0	65.0	D
1280 x 800	1 280 x 800	49.7	59.8	83.5	D
1366 x 768	1 366 x 768	47.7	59.8	85.5	D
SXGA+	1 400 x 1 050	65.2	60.0	122.6	D
WUXGA*1*2	1 920 x 1 200	74.0	60.0	154.0	D

*1 VESA CVT-RB (Reduced Blanking) compliant

*2 When the display (projector or flat panel display) connected with the DIGITAL LINK is supporting the long reach communication method, it is not supporting the output.

List of 3D compatible signals (input/output)

The following are 3D signals supported by this device (HDMI signal only). Output of 3D signal is supported only by the <DIGITAL LINK OUT 1> terminal/<DIGITAL LINK OUT 2> terminal, and it is not supported by the <DVI-D OUT> terminal.

- If 3D signal is input while the display (projector or flat panel display) that does not support 3D is connected, an icon notifying that it cannot output 3D image is displayed at the top right of the image, and the image disappears. In this case, change the input signal to the 2D.

3D compatible signal	Format of 3D video signal		
	Frame packing	Side by side	Top and bottom
750 (720)/60p	✓*1	✓	✓*1
750 (720)/50p	✓*1	✓	✓*1
1125 (1080)/60i	—	✓*1	—
1125 (1080)/50i	—	✓*1	—
1125 (1080)/24p	✓*1	✓	✓*1
1125 (1080)/60p	—	✓	✓
1125 (1080)/50p	—	✓	✓

*1 HDMI standard 3D Mandatory format signal.

Note

- To output the 3D signal, go to the [OPTION] menu → [DIGITAL LINK OUT] (➔ page 52) and set [FRAME LOCK] to [ON]. The 3D signal is not output when [OFF] is set.

Specifications

The specifications of this device are as follows.

Power supply (DC Input terminal)		16 V = (16 V Direct Current)
Power consumption		32 W (when power supply is "off": 0.15 W) (including the supplied AC adapter)
AC adapter	CF-AA6373A	Input: AC 100 V - 240 V, 1.5 A - 0.8 A, 50 Hz/60 Hz Output: DC 16 V, 3.75 A
	CF-AA6413A	Input: AC 100 V - 240 V, 1.6 A - 0.9 A, 50 Hz/60 Hz Output: DC 16 V, 4.06 A
Power cord length		2.0 m (78-3/4")
Dimensions	Width	210 mm (8-9/32")
	Height	44 mm (1-23/32")
	Depth	250 mm (9-27/32") (excluding protrusion)
Weight¹		Approx. 1.3 kg (2.9 lbs.) (main body) Approx. 0.2 kg (0.4 lbs.) (supplied AC adapter)
Operating environment	Operating environment temperature²	0 °C (32 °F) - 40 °C (104 °F)
	Operating environment humidity	20 % - 80 % (no condensation)

*1 Accessories such as the power cord and mounting bracket are not included.

*2 When using the device at elevations between 1 400 m (4 593') and 2 700 m (8 858') above sea level, the operating environment temperature should be between 0 °C (32 °F) and 35 °C (95 °F). The device cannot be used at elevations of 2 700 m (8 858') or higher above sea level.

■ Applicable scanning frequency

For details of the video signal supported by this device, refer to “Compatible signals” (➔ page 88).

Input	Video signal	Horizontal 15.73 kHz, Vertical 59.94 Hz (NTSC/NTSC4.43/PAL-M/PAL60)	
	Y/C signal	Horizontal 15.63 kHz, Vertical 50 Hz (PAL/PAL-N/SECAM)	
	RGB signal	Horizontal 15.6 kHz to 98.8 kHz, Vertical 24.0 Hz to 120.0 Hz • Dot clock frequency: 13.5 MHz to 162.0 MHz	
	YC _B C _R /YP _B P _R signal	<ul style="list-style-type: none"> • 525i (480i) Horizontal 15.73 kHz, Vertical 59.94 Hz • 525p (480p) Horizontal 31.47 kHz, Vertical 59.94 Hz • 750 (720)/60p Horizontal 45.0 kHz, Vertical 60 Hz • 1125 (1080)/60i Horizontal 33.75 kHz, Vertical 60 Hz • 1125 (1080)/25p Horizontal 28.13 kHz, Vertical 25 Hz • 1125 (1080)/24sF^{*1} Horizontal 27.0 kHz, Vertical 48 Hz • 1125 (1080)/60p Horizontal 67.5 kHz, Vertical 60 Hz 	<ul style="list-style-type: none"> • 625i (576i) Horizontal 15.63 kHz, Vertical 50 Hz • 625p (576p) Horizontal 31.25 kHz, Vertical 50 Hz • 750 (720)/50p Horizontal 37.5 kHz, Vertical 50 Hz • 1125 (1080)/50i Horizontal 28.13 kHz, Vertical 50 Hz • 1125 (1080)/24p Horizontal 27.0 kHz, Vertical 24 Hz • 1125 (1080)/30p Horizontal 33.75 kHz, Vertical 30 Hz • 1125 (1080)/50p Horizontal 56.25 kHz, Vertical 50 Hz
HDMI signal	525i (480i) ^{*2} , 625i (576i) ^{*2} , 525p (480p), 625p (576p), 750 (720)/60p, 750 (720)/50p, 1125 (1080)/60i, 1125 (1080)/50i, 1125 (1080)/60p, 1125 (1080)/50p, 1125 (1080)/24p, 1125 (1080)/24sF ^{*1} , 1125 (1080)/25p, 1125 (1080)/30p • Displayable resolution: VGA (640 x 480) to WUXGA (1 920 x 1 200), VESA CVT-RB (Reduced Blanking) compliant • Dot clock frequency: 25.2 MHz to 162.0 MHz		
Output ^{*3}	<ul style="list-style-type: none"> • 720/60p (1 280 x 720) Horizontal 45.0 kHz, Vertical 60.0 Hz • 1080/24p (1 920 x 1 080) Horizontal 27.0 kHz, Vertical 24.0 Hz • 1080/30p (1 920 x 1 080) Horizontal 33.8 kHz, Vertical 30.0 Hz • 1080/50p (1 920 x 1 080) Horizontal 56.3 kHz, Vertical 50.0 Hz • 1280 x 800 (1 280 x 800) Horizontal 49.7 kHz, Vertical 59.8 Hz • SXGA+ (1 400 x 1 050) Horizontal 65.2 kHz, Vertical 60.0 Hz 	<ul style="list-style-type: none"> • 720/50p (1 280 x 720) Horizontal 37.5 kHz, Vertical 50.0 Hz • 1080/25p (1 920 x 1 080) Horizontal 28.1 kHz, Vertical 25.0 Hz • 1080/60p (1 920 x 1 080) Horizontal 67.5 kHz, Vertical 60.0 Hz • XGA (1 024 x 768) Horizontal 48.4 kHz, Vertical 60.0 Hz • 1366 x 768 (1 366 x 768) Horizontal 47.7 kHz, Vertical 59.8 Hz • WUXGA (1 920 x 1 200)^{*4*5} Horizontal 74.0 kHz, Vertical 60.0 Hz 	
		• Dot clock frequency: 65.0 MHz to 154.0 MHz	

*1 Does not support the frame lock.

*2 Pixel-Repetition signal (dot clock frequency 27.0 MHz) only

*3 The supported output signal for the <DIGITAL LINK OUT 1> terminal/<DIGITAL LINK OUT 2> terminal is same as the <DVI-D OUT> terminal. However, output of 3D signal is supported only by the <DIGITAL LINK OUT 1> terminal/<DIGITAL LINK OUT 2> terminal, and it is not supported by the <DVI-D OUT> terminal.

*4 VESA CVT-RB (Reduced Blanking) compliant

*5 When the display (projector or flat panel display) connected with the DIGITAL LINK is supporting the long reach communication method, it is not supporting the output.

■ Terminal

<p><COMPUTER 1 IN> terminal/<COMPUTER 2 IN> terminal</p>	<p>2 sets, high-density D-Sub 15 p (female)</p> <p>RGB signal 0.7 V [p-p] 75 Ω (SYNC ON GREEN: 1.0 V [p-p] 75 Ω)</p> <p> HD/SYNC TTL high impedance, automatic positive/negative polarity compatible</p> <p> VD TTL high impedance, automatic positive/negative polarity compatible</p> <p> (HD/SYNC and VD do not support 3 value SYNC.)</p> <p>YP_BP_R signal Y: 1.0 V [p-p] including synchronization signal, P_BP_R: 0.7 V [p-p] 75 Ω</p> <p>Y/C signal*1 Y: 1.0 V [p-p], C: 0.286 V [p-p] 75 Ω</p>
<p><VIDEO IN> terminal</p>	<p>1 set, Pin jack 1.0 V [p-p] 75 Ω</p>
<p><HDMI 1 IN> terminal/<HDMI 2 IN> terminal</p>	<p>2 sets, HDMI 19 p, HDCP compatible, Deep Color compatible Audio signal: Linear PCM (sampling frequency: 48 kHz/44.1 kHz/32 kHz)</p>
<p><SERIAL IN> terminal</p>	<p>1 set, 3-pin 3.5 mm detachable terminal block, for external control (RS-232C compliant)</p>
<p><AUDIO IN 1> terminal/<AUDIO IN 2> terminal/<AUDIO IN 3> terminal</p>	<p>3 sets, M3 stereo mini jack 0.5 V [rms], input impedance 22 kΩ or higher</p>
<p><AUDIO OUT> terminal</p>	<p>1 set, M3 stereo mini jack (monitor output, stereo can be supported) 0 V [rms] to 2.0 V [rms] (variable), output impedance 2.2 kΩ or lower</p>
<p><DVI-D OUT> terminal</p>	<p>1 set, DVI-D 24 p</p>
<p><LAN> terminal</p>	<p>1 set, RJ-45, for network connection, PLink compatible, 10Base-T/100Base-TX</p>
<p><DIGITAL LINK OUT 1> terminal/<DIGITAL LINK OUT 2> terminal</p>	<p>2 sets, RJ-45, for DIGITAL LINK connection (HDBaseT™ compliant)</p>
<p><REMOTE IN> terminal</p>	<p>1 set, D-Sub 9 p, for external control (contact control)</p>

*1 Only the <COMPUTER 1 IN> terminal can input Y/C signal using the optional D-SUB - S Video conversion cable (Model No.: ET-ADSV).

Dimensions

Unit: mm

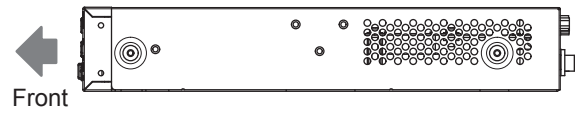
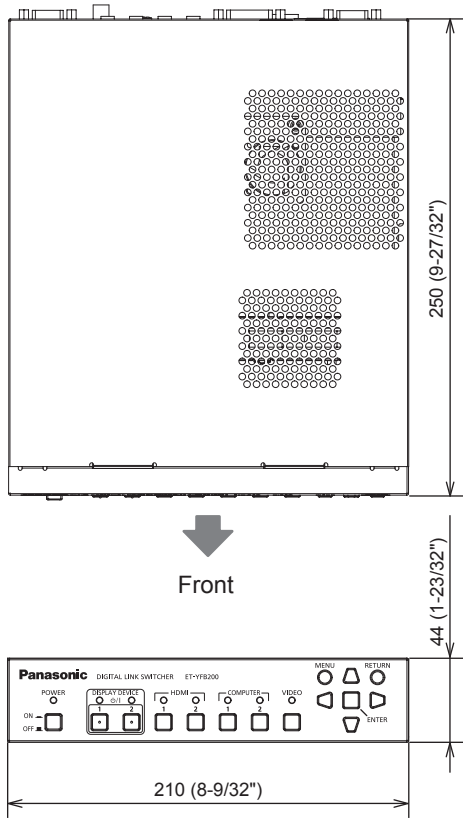

■ When mounting a rack

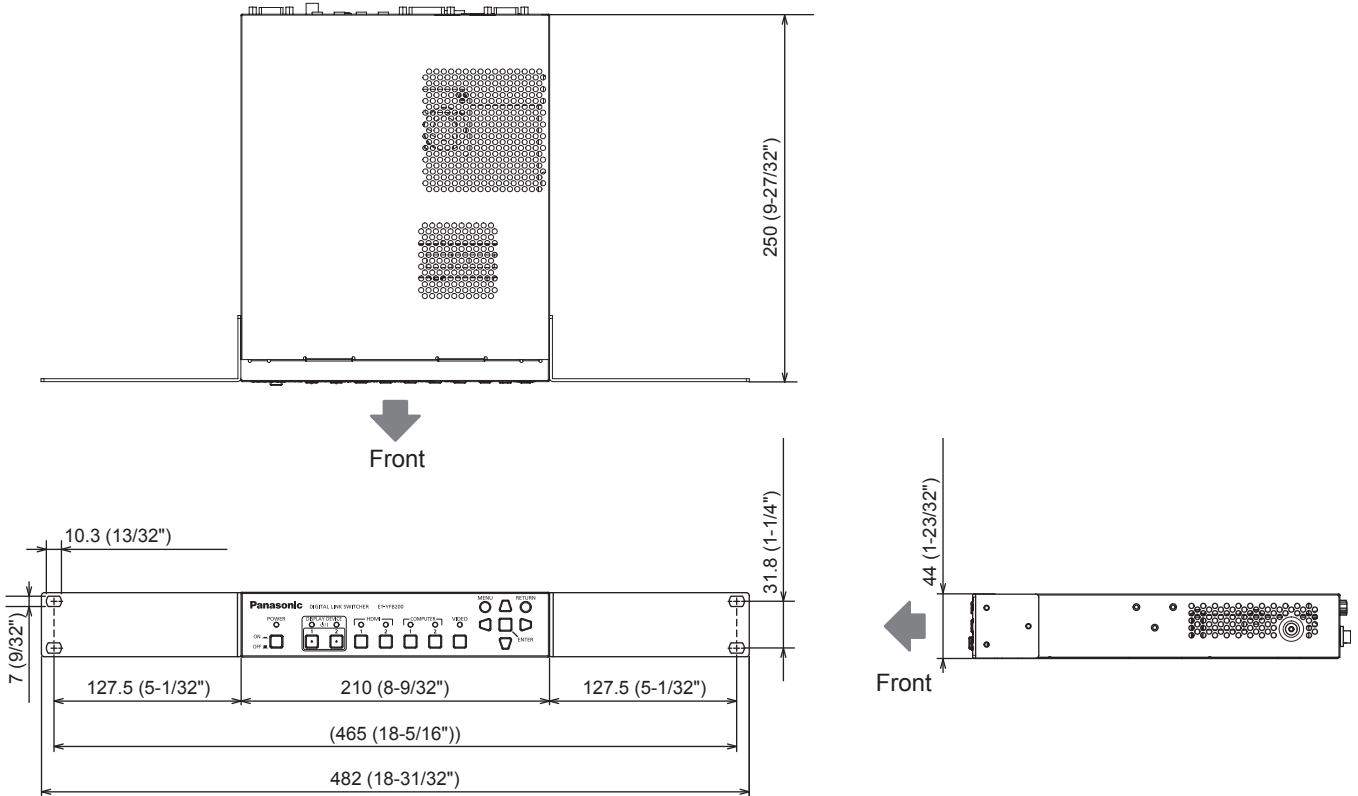

■ When placing on a desk or a shelf

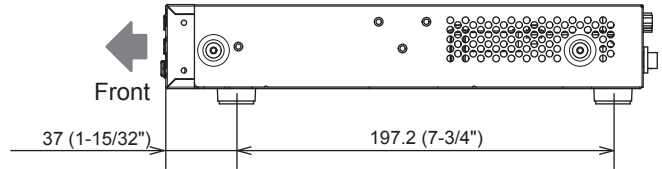
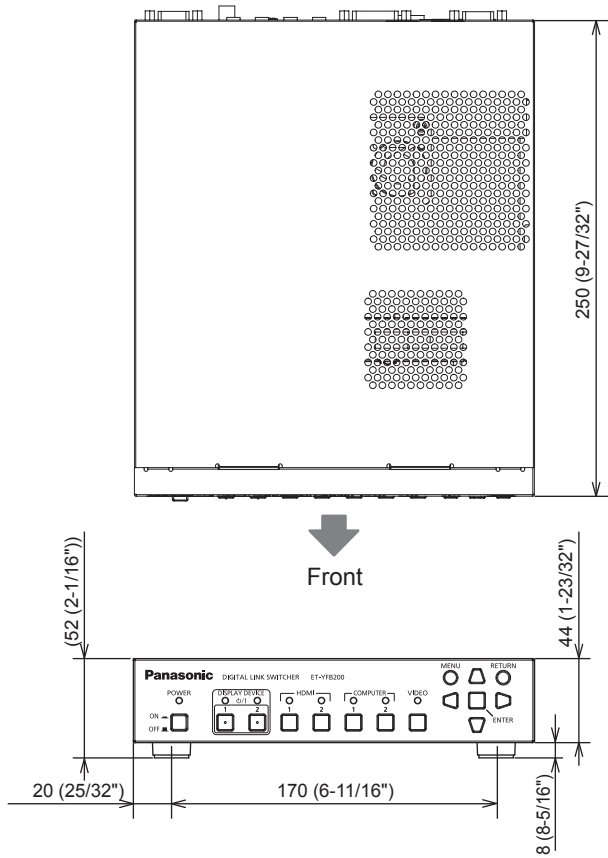

Index

- A**
- AC adapter 30
 - Accessories 14
 - [ASPECT] 45
 - <AUDIO IN 1> terminal 18
 - <AUDIO IN 2> terminal 18
 - <AUDIO IN 3> terminal 18
 - <AUDIO OUT> terminal 18
 - [AUDIO SETTING] 55
 - [AUTO SETUP] 57
- B**
- [BACK COLOR] 55
 - [BACKUP INPUT SETTING] 57
 - Browser remote control 73
- C**
- Cautions when installing 12
 - Cautions when transporting 12
 - CD-ROM 15
 - [CLAMP POSITION] 42
 - [CLOCK PHASE] 44
 - [CLOSED CAPTION SETTING] 54
 - Compatible signals
 - List of 3D compatible signals (input/output) 90
 - List of compatible signals (input) 88
 - List of compatible signals (output) 90
 - <COMPUTER 1> button 17
 - <COMPUTER 1 IN> terminal 18
 - <COMPUTER 2> button 17
 - <COMPUTER 2 IN> terminal 18
 - [COMPUTER IN] 48
 - Connecting the AC adapter 30
 - Connecting the power cord 30
 - Connection 22
- D**
- <DC IN> terminal 18, 30
 - [DIGITAL CINEMA REALITY] 43
 - DIGITAL LINK 13
 - [DIGITAL LINK OUT] 52
 - <DIGITAL LINK OUT 1> terminal 18
 - <DIGITAL LINK OUT 2> terminal 18
 - Dimensions 94
 - <DISPLAY DEVICE 1> button 17, 32, 33
 - <DISPLAY DEVICE 2> button 17, 32, 33
 - Display device indicator 17
 - Display language 40, 47
 - Disposal 13
 - [DVI-D OUT] 53
 - <DVI-D OUT> terminal 18
- E**
- Early Warning Software 13
 - <ENTER> button 17
- H**
- <HDMI 1> button 17
 - <HDMI 1 IN> terminal 18
 - <HDMI 2> button 17
 - <HDMI 2 IN> terminal 18
 - [HDMI IN] 50
- I**
- [INITIALIZE] 62
 - [INPUT RESOLUTION] 45
 - [INPUT SELECT] 39, 41
 - Input terminal indicator 17
- L**
- <LAN> terminal 18
- M**
- Main body 16
 - Main menu 39
 - Maintenance 76
 - <MENU> button 17, 38
 - Menu item 39
- N**
- Navigating through the menu 38
 - [NETWORK] 60
 - [NO SIGNAL SLEEP] 55
- O**
- On-screen menu 38
 - [ON-SCREEN SETTING] 48
 - Operating with the remote control 35
 - [OPTION] 40, 48
- Optional accessories 15
 - [OVER SCAN] 45
- P**
- [PICTURE] 40, 42
 - [POSITION] 40, 44
 - <POWER> button 17, 31
 - Power cord 30
 - Power indicator 17
 - Precautions for use 12
- R**
- Read this first! 4
 - <REMOTE IN> terminal 18, 87
 - Resetting to factory default 39
 - <RETURN> button 17
 - [RS-232C] 58, 83
- S**
- Selecting the image to display 34
 - <SERIAL IN> terminal 18, 83
 - Setting up 20
 - [SHIFT] 44
 - Specifications 91
 - [STATUS] 61
 - Switching the input 35
 - [SYSTEM SELECTOR] 42
- T**
- Troubleshooting 77
 - Turning off the power
 - Display 32, 33
 - Main body 31
 - Turning on the power
 - Display 32, 33
 - Main body 31
- V**
- <VIDEO> button 17
 - <VIDEO IN> terminal 18
- W**
- Web control function 66

Disposal of Old Equipment

Only for European Union and countries with recycling systems



This symbol on the products, packaging, and/or accompanying documents means that used electrical and electronic products must not be mixed with general household waste.

For proper treatment, recovery and recycling of old products, please take them to applicable collection points in accordance with your national legislation.

By disposing of them correctly, you will help to save valuable resources and prevent any potential negative effects on human health and the environment.

For more information about collection and recycling, please contact your local authority.

Penalties may be applicable for incorrect disposal of this waste, in accordance with national legislation.

Information on Disposal in other Countries outside the European Union

This symbol is only valid in the European Union.

If you wish to discard this product, please contact your local authorities or dealer and ask for the correct method of disposal.

Product Information (for Turkey only)

AEEE Yönetmeliğine Uygundur.

Eski Ekipman İşlenmesi.

Sadece geri dönüşüm sistemleri olan Avrupa Birliği ve ülkeleri için geçerlidir.



Ürünler, ambalaj ve/veya ekli belgeler üzerindeki bu semboller kullanılmış elektrik ve elektronik ürünlerin genel ev atığı ile karıştırılmaması gerektiğini ifade eder.

Eski ürünlerin toplanması ve geri kazanılması için bu atıkları lütfen yasayla belirlenmiş olan uygun toplama merkezlerine teslim ediniz.

Bu atıkların doğru işlenmesiyle, değerli kaynakların korunmasına ve insan sağlığı ve çevreye olası negatif etkilerinin engellenmesine yardımcı olabilirsiniz.

Atıkların toplanması ve geri dönüşümü için detaylı bilgi için lütfen bağlı olduğunuz yerel yönetimlerle iletişime geçiniz.

Atıkların atılmasıyla ilgili yanlış uygulamalar yasayla belirlenmiş olan cezalara sebebiyet verebilir.

Panasonic Corporation

Web Site : <https://panasonic.net/cns/projector/>

© Panasonic Corporation 2015

Panasonic System Solutions Company of North America

Two Riverfront Plaza, Newark, NJ 07102

TEL: (877) 803 - 8492

Panasonic Canada Inc.

5770 Ambler Drive, Mississauga, Ontario L4W 2T3

TEL: (905) 624 - 5010